

**1x**

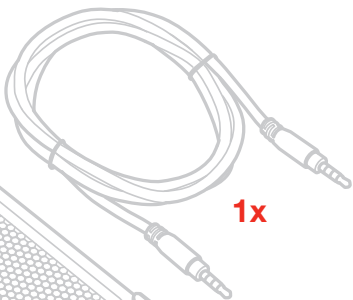

**1x**

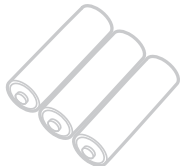

**3x**

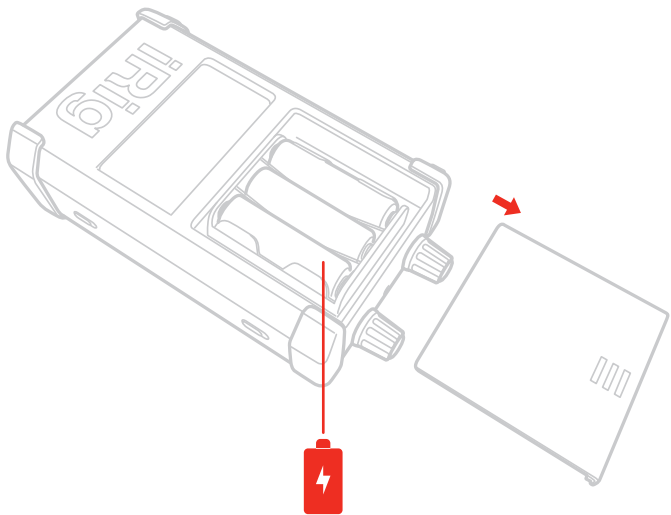

A

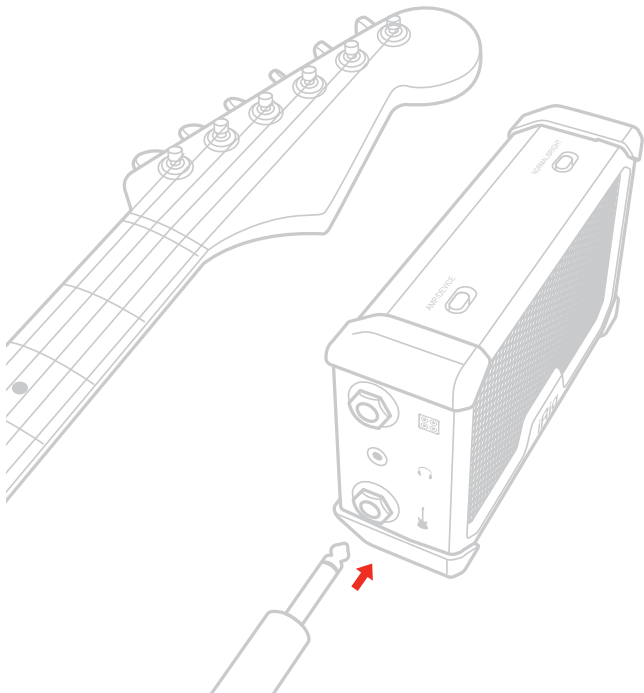

A

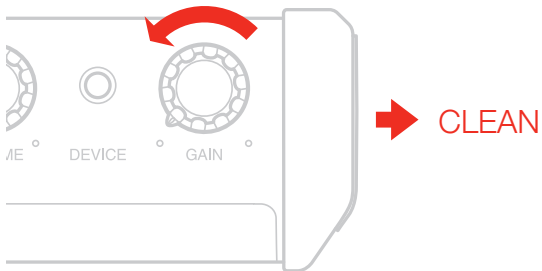

**GAIN**

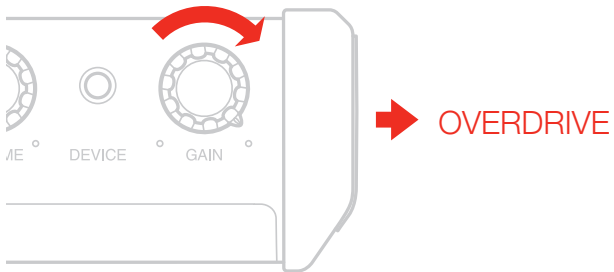

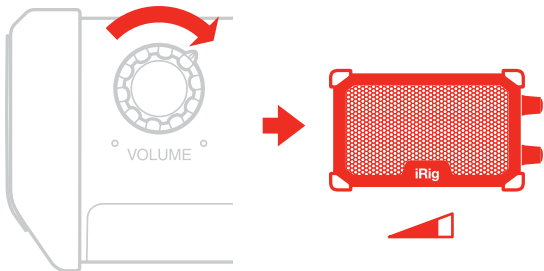

**VOLUME**

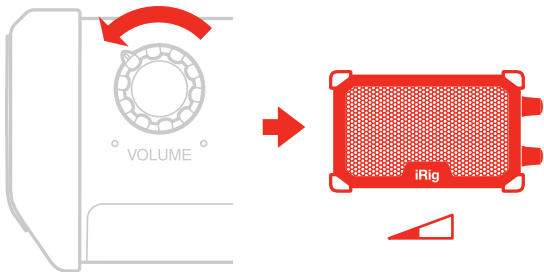

A

NORMAL/BRIGHT

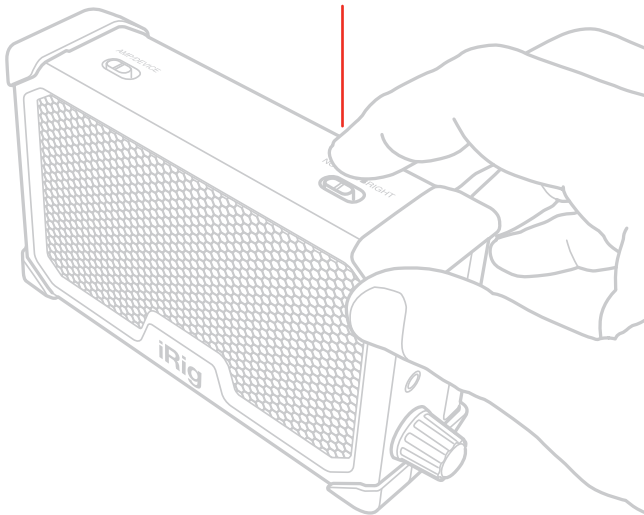

AMP/DEVICE

A



**AMP** ←

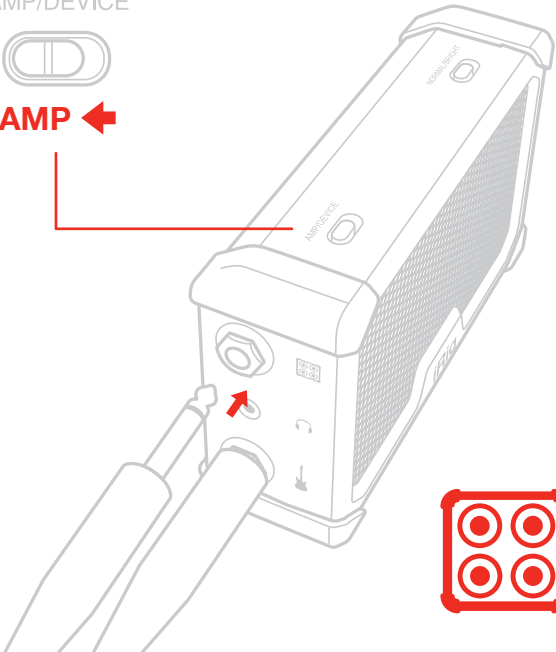

A

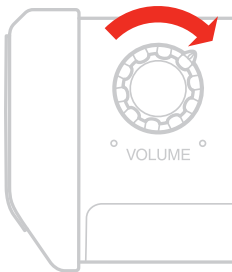

**VOLUME**

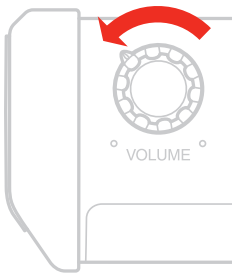

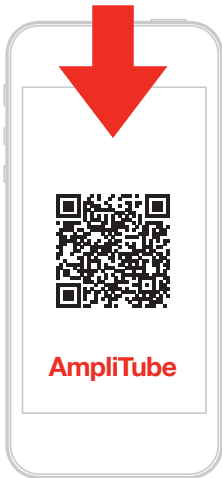

[ikdownloads.com/irignanoamp](https://ikdownloads.com/irignanoamp)

B

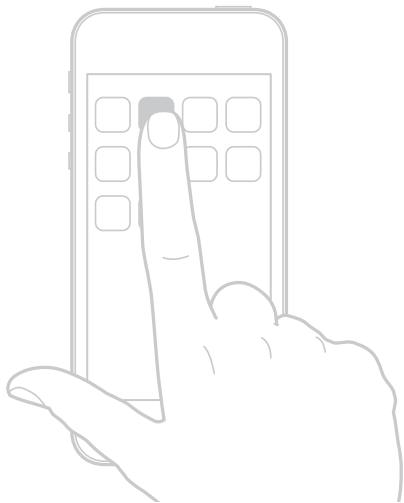

B

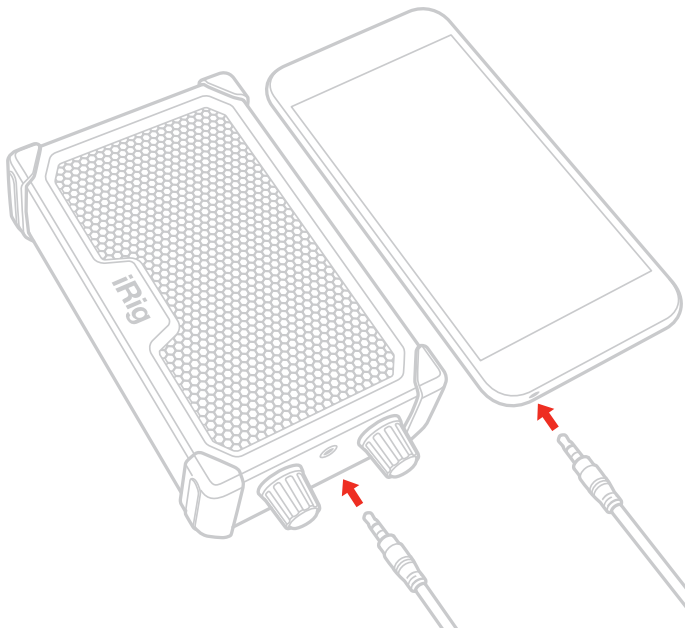

B

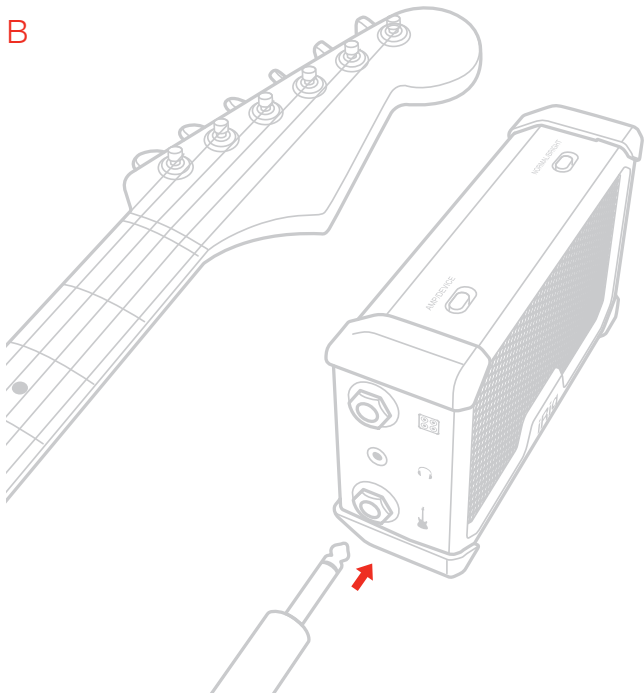

B

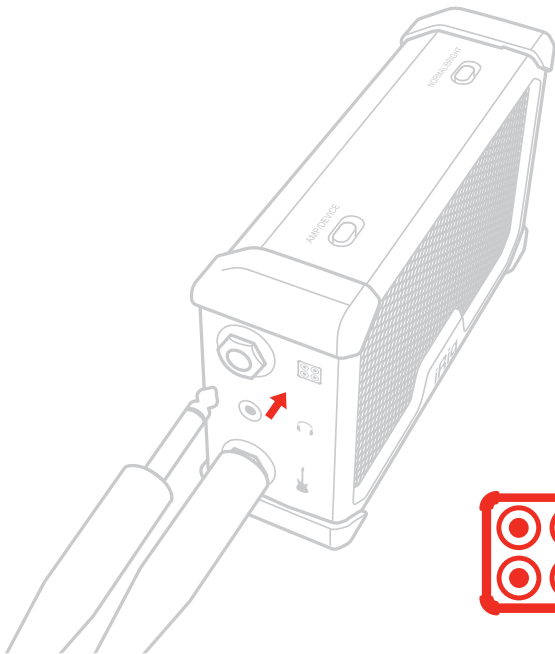

B

AMP/DEVICE



**AMP** ←

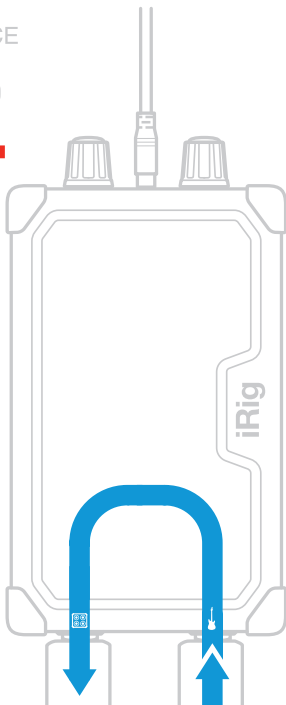

B

AMP/DEVICE



➔ **DEVICE**

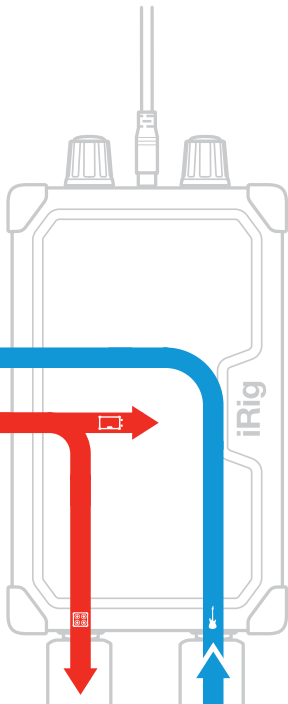

AMP/DEVICE



➔ **DEVICE**



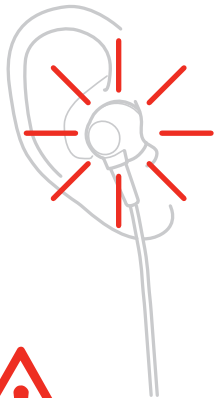
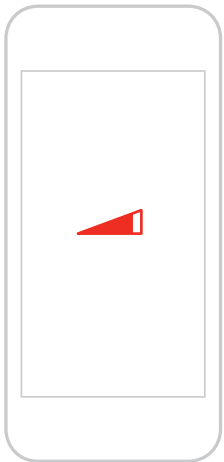

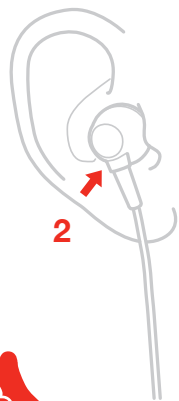
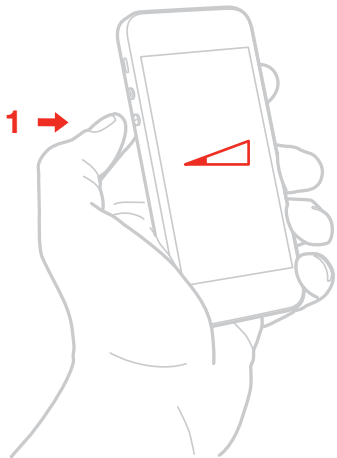

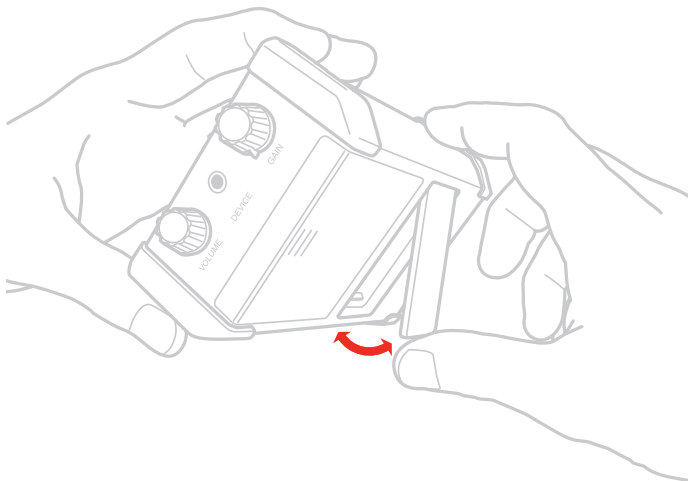

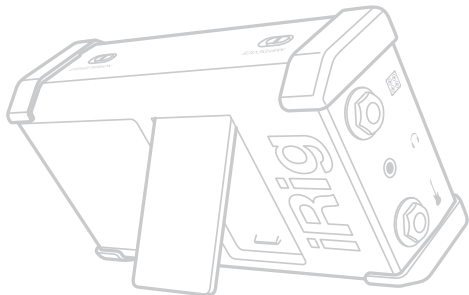
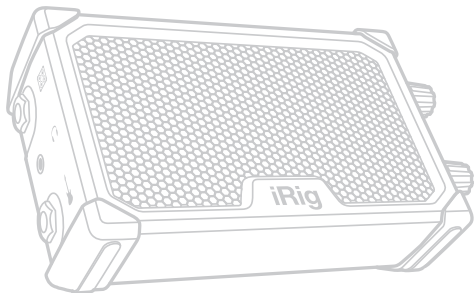

: « ». : , 105066,  
, . , .5, .1, 10.  
: , 111250,  
« », .6, .1.  
:  
:  
46, 41122 , . . ,  
RU  
-IT. 15. .10611, 01.11.2022 .  
" "  
2 . 1  
:  
:  
+10° +35° ;  
:  
2019 .

