

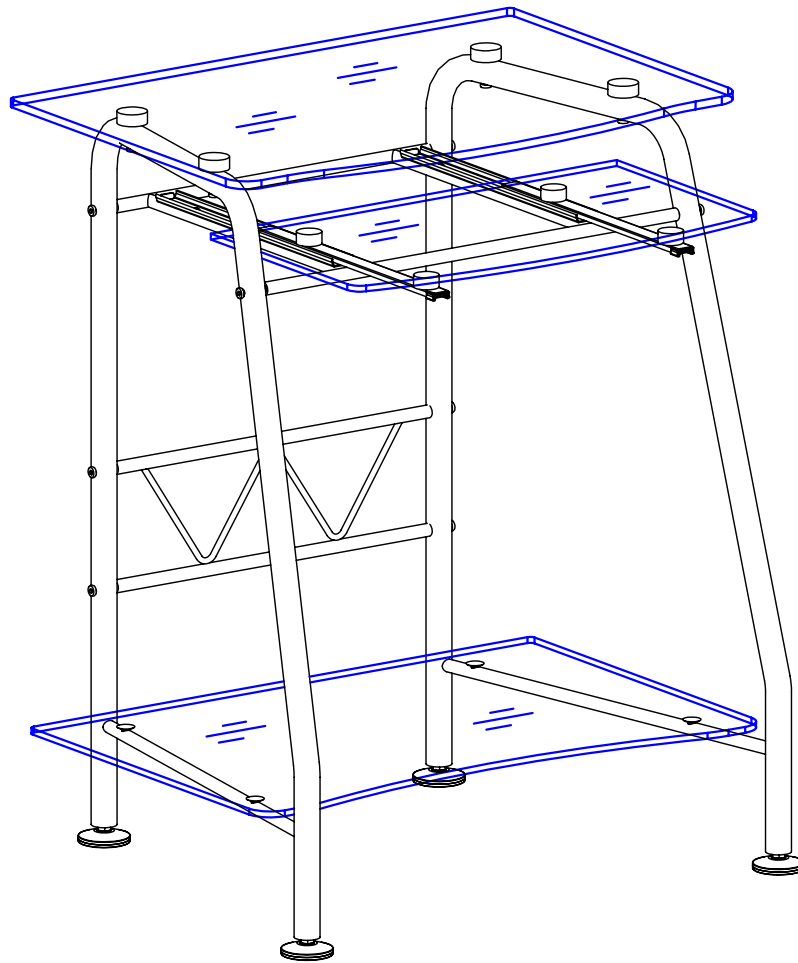





Assembly Instruction



<p>(A)</p>  <p>1/4"x2"x8PCS</p>	<p>(B)</p>  <p>1/4"x1-1/4"x4PCS</p>	<p>(C)</p>  <p>3/16"x3/8"x8PCS</p>
<p>(D)</p>  <p>4PCS</p>	<p>(E)</p>  <p>4PCS</p>	<p>(F)</p>  <p>4MMx1PC</p>

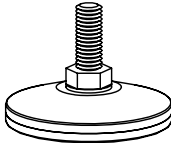