

Quick Start Guide

NBG6604

AC1200 Dual-Band Wireless Router



ZYXEL ENGLISH | DEUTSCH | FRANÇAIS | ITALIANO | ESPAÑOL | NEDERLANDS

Option 1 Setup with Your Mobile Device

Step 1

Method A

- Launch the app store on your mobile device.
 - On iOS devices this is called the "App Store"
 - On Android devices it is called the "Play Store"
- Search for "**Zyxel One Connect**"



Method B

If your phone has a QR code scanner, scan the following QR code. Alternatively, you can visit the following link from the web browser on your mobile device:

<http://www.zyxel.com/oneConnectApp/index.html>



Step 2

Open the Zyxel ONE Connect app and follow the installation instructions.

Option 2 Setup Using Your Computer

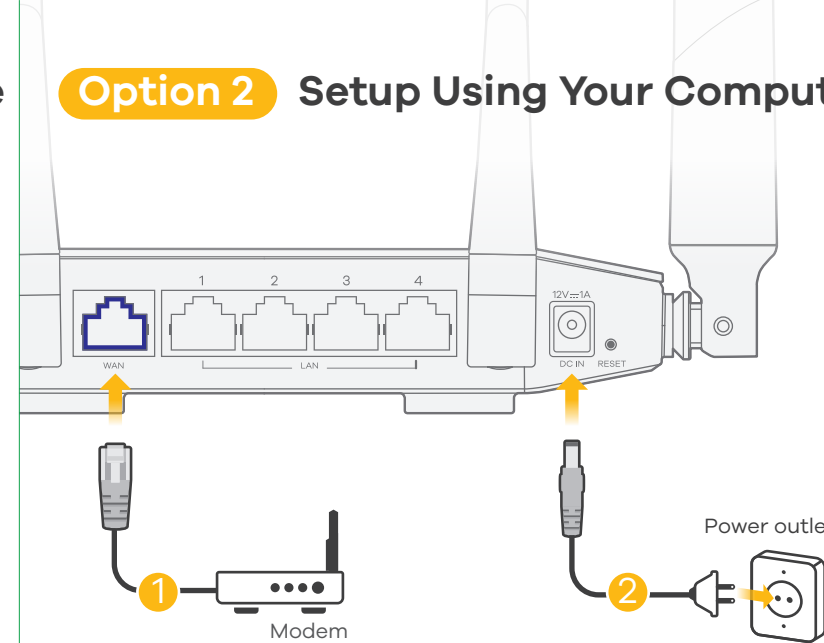

Check the LEDs

Wait for the LEDs to turn on.

Power On 5G On 2.4G On

3-1 Wi-Fi Connection



2.4G Wi-Fi Name (SSID)
Zyxelxxxxxx
5G Wi-Fi Name (SSID)
Zyxelxxxxx.speed
Wi-Fi Password
XXXXXXXXXXXX



3-2 Ethernet Cable Connection

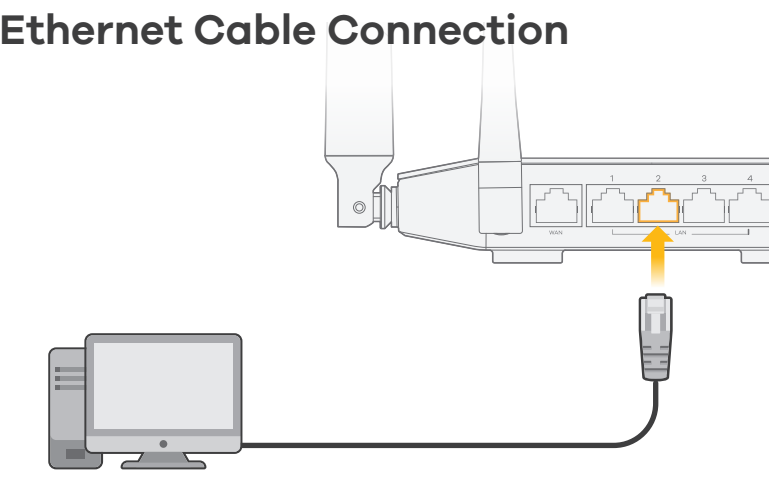

4 Configure Your Device

<http://myrouter>

Login Password: **1234**
(default)

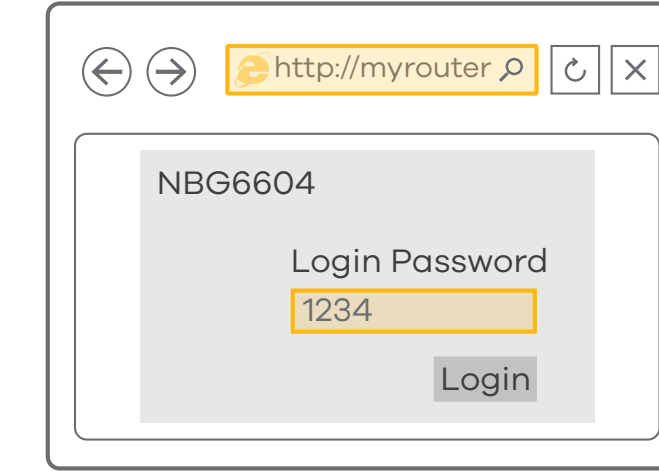

ZYXEL
Your Networking Ally



Warranty Card

Thank you for purchasing a Zyxel product. Zyxel has a reputation for delivering high quality, high performance products and services to our customers. We recommend that you now visit the Zyxel website and register your product online. This will mean you can receive the latest firmware, drivers and product related information. If you still have further questions or enquiries related to the product, please contact our subsidiaries worldwide. Please note that warranty terms may vary by region. Full detailed information is available on our website, here: http://www.zyxel.com/support/warranty_information.shtml

Purchase Information

Zyxel Product Name:

Hardware Serial Number:

Date of Purchase:

(In certain countries, the warranty will be validated with seller's signature and stamp):

- EN** 1 Download and install the Zyxel ONE Connect app via the App Store, Play Store, or QR code on your Android or iOS devices.
2 Open the Zyxel ONE Connect app and follow the installation instructions.
- DE** 1 Laden und installieren Sie die Zyxel ONE Connect App über den App Store, Play Store oder den QR Code auf Ihre Android oder iOS Geräte.
2 Öffnen Sie die Zyxel ONE Connect App und folgen Sie den Anweisungen.
- FR** 1 Téléchargez et installez l'application Zyxel ONE Connect via l'App Store, le Play Store ou en scannant le QR code à partir de votre smartphone iOS ou Android.
2 Ouvrez l'application Zyxel ONE Connect et suivez les instructions d'installation.
- IT** 1 Scarica e installa la Zyxel ONE Connect app tramite App Store, Play Store, o QR code sui tuoi dispositivi Android o iOS.
2 Apri la Zyxel ONE Connect app e segui le istruzioni per l'installazione.
- ES** 1 Descargue e instale la aplicación Zyxel ONE Connect a través de App Store, Play Store o código QR en sus dispositivos Android o iOS.
2 Abra la aplicación Zyxel ONE Connect y siga las instrucciones de instalación.
- NL** 1 Download en installeer de Zyxel ONE Connect app via de App Store, Play Store, of QR-code op jouw Android of iOS apparaten.
2 Open de Zyxel ONE Connect app en volg de instructies voor het installeren.

- EN** 1 Use an Ethernet cable to connect the NBG6604's blue WAN port to a broadband modem that has Internet access.
2 Use the included power adaptor to connect the power socket to a power outlet.
- DE** 1 Schließen Sie ein Breitbandmodem oder Router mit Internetzugang über ein Ethernetkabel an den blauen WAN Port des NBG6604 an.
2 Schließen Sie den mitgelieferten Netzadapter an den Netzanschluss und an eine Netzsteckdose an.
- FR** 1 Utilisez un câble Ethernet pour raccorder le port WAN bleu du NBG6604 à un modem connecté à Internet.
2 Utilisez l'adaptateur d'alimentation inclus pour raccorder le NBG6604 à une prise de courant.
- IT** 1 Collegare un modem a banda larga o router dotato di accesso a Internet alla porta WAN blu dell'NBG6604 con un cavo Ethernet.
2 Utilizzare l'alimentatore fornito a corredo per collegare la presa di alimentazione a una presa della corrente.
- ES** 1 Conecte un módem o router de banda ancha con acceso a Internet al puerto WAN azul del NBG6604 con un cable Ethernet.
2 Utilice el adaptador de alimentación incluido para conectar el enchufe de alimentación a una toma de corriente.
- NL** 1 Sluit een breedbandmodem of -router (met internettoegang) aan op de blauwe WAN-poort van de NBG6604 met een ethernetkabel.
2 Gebruik de bijgesloten stroomadapter om de router op een stopcontact aan te sluiten.

- EN** 3-1 For iOS and other wireless devices, find the Wi-Fi name (SSID) and enter the Wi-Fi password.
3-2 Connect a computer to one yellow LAN port of the NBG6604.
- DE** 3-1 Suchen Sie mit iOS und anderen drahtlosen Geräten nach dem WLAN-Namen (SSID) und geben Sie das WLAN-Passwort ein.
3-2 Schließen Sie einen Computer an einen gelben LAN Port des NBG6604 an.
- FR** 3-1 Pour les terminaux sans fil, trouvez le nom du réseau WiFi (SSID) et saisissez le mot de passe.
3-2 Connectez un ordinateur à l'un des ports LAN jaunes du NBG6604.
- IT** 3-1 Per iOS e altri dispositivi wireless, trova il nome Wi-Fi (SSID) e immetti la password Wi-Fi.
3-2 Collegare un computer a una porta LAN gialla dell'NBG6604.
- ES** 3-1 Para iOS y otros dispositivos inalámbricos, busque el nombre Wi-Fi (SSID) y escriba la contraseña Wi-Fi.
3-2 Conecte un equipo a un puerto LAN amarillo del NBG6604.
- NL** 3-1 Zoek voor iOS en andere draadloze apparaten de Wi-Fi-naam (SSID) en voer het Wi-Fi-wachtwoord in.
3-2 Sluit een computer aan op een gele LAN-poort van de NBG6604.

- EN** 4 **Configure the NBG6604.**
From the connected device, open a web browser and type <http://myrouter>. Enter **1234** as the password and click **Login**.
- DE** 4 **Ihr Gerät konfigurieren**
Öffnen Sie einen Webbrowser auf dem angeschlossenen Gerät und geben Sie <http://myrouter> ein. Geben Sie als Kennwort **1234** ein, und klicken Sie auf Anmelden.
- FR** 4 **Configurez votre équipement**
Depuis le terminal connecté, saisissez l'adresse <http://myrouteur> dans un navigateur Web. Saisissez le mot de passe **1234** et cliquez sur Connexion.
- IT** 4 **Configurare il dispositivo**
Da un dispositivo connesso, aprire un browser e digitare <http://myrouter>. Immettere la password **1234** e fare clic su **Login**.
- ES** 4 **Configurar su dispositivo**
En el dispositivo conectado, abra un navegador web y escriba <http://myrouter>. Escriba **1234** como contraseña y haga clic en **Login** (Iniciar sesión).
- NL** 4 **Configureer Uw Apparaat**
Open uit het aangesloten apparaat een webbrowser en typ <http://myrouter>. Voer **1234** in als wachtwoord en klik op **Login**.

Support Information

North America USA ☎ +1 800 978 7222
✉ support@zyxel.com

Italy ☎ + 39 011 2308000
✉ support@zyxel.it

UK ☎ + 44 3331 559 301
✉ support@zyxel.co.uk

Spain ☎ + 911 792 100
✉ soporte@zyxelles.com

Germany ☎ + 49 2405 690969
✉ support@zyxel.de

France ☎ + 33 4 72 52 97 97
✉ support@zyxel.fr

Netherlands ☎ +31 (0)88-00029112
✉ support@zyxel.nl

See the User's Guide at www.zyxel.com for more information, including customer support and safety warnings.

EU Importer
Zyxel Communications A/S
Generatorvej 8D, 2860 Søborg, Denmark.
<http://www.zyxel.dk>

US Importer
Zyxel Communications, Inc
1130 North Miller Street Anaheim, CA 92806-2001
<http://www.us.zyxel.com>

Quick Start Guide

NBG6604

AC1200 Dual-Band Wireless Router



ZYXEL ENGLISH | DANSK | NORSK | SUOMI | SVENSKA

Option 1 Setup with Your Mobile Device

Step 1

Method A

- Launch the app store on your mobile device.
 - On iOS devices this is called the "App Store"
 - On Android devices it is called the "Play Store"
- Search for "Zyxel One Connect"



Method B

If your phone has a QR code scanner, scan the following QR code. Alternatively, you can visit the following link from the web browser on your mobile device:

<http://www.zyxel.com/oneConnectApp/index.html>



Step 2

Open the Zyxel ONE Connect app and follow the installation instructions.

Option 2 Setup Using Your Computer

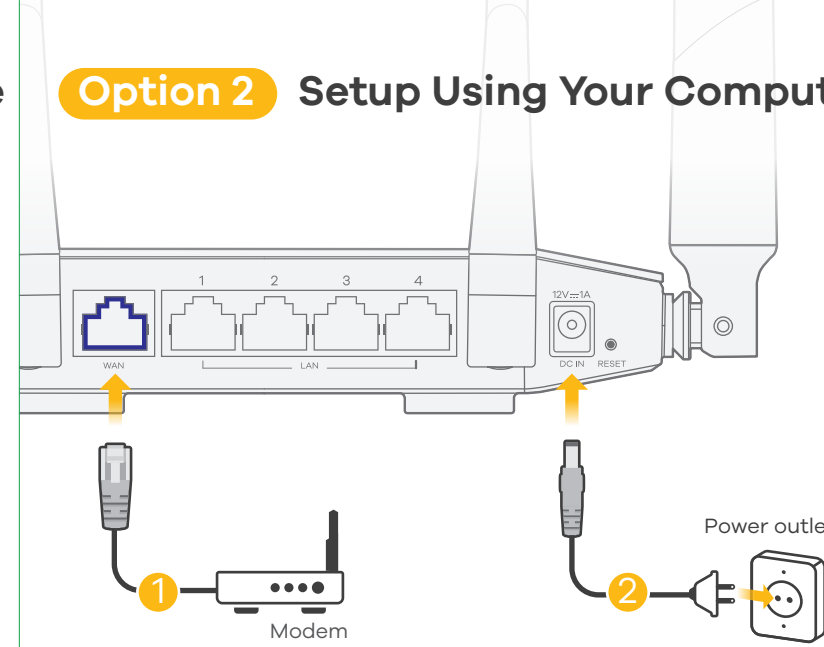

Check the LEDs

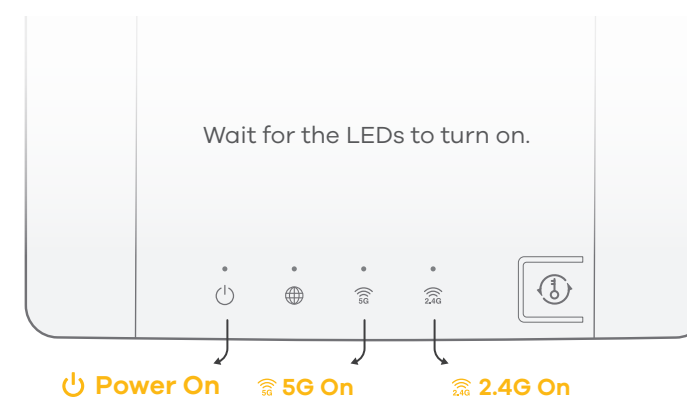

3-1 Wi-Fi Connection



2.4G Wi-Fi Name (SSID)
Zyxelxxxxxx

5G Wi-Fi Name (SSID)
Zyxelxxxxx.speed

Wi-Fi Password
XXXXXXXXXXXX



3-2 Ethernet Cable Connection

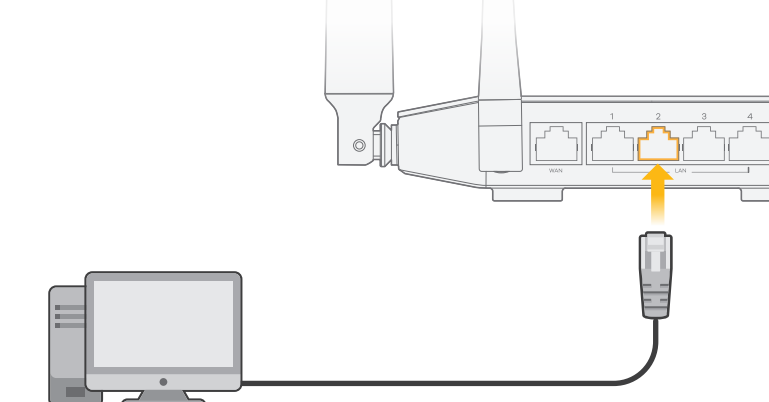

4 Configure Your Device

<http://myrouter>

Login Password: **1234**
(default)

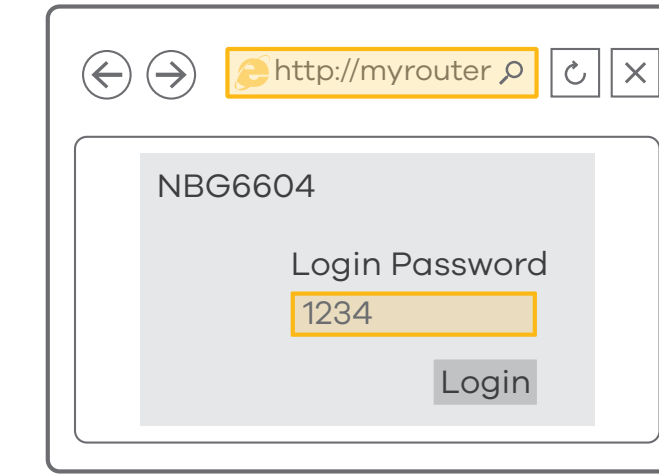

ZYXEL

Your Networking Ally



Warranty Card

Thank you for purchasing a Zyxel product. Zyxel has a reputation for delivering high quality, high performance products and services to our customers. We recommend that you now visit the Zyxel website and register your product online. This will mean you can receive the latest firmware, drivers and product related information. If you still have further questions or enquiries related to the product, please contact our subsidiaries worldwide. Please note that warranty terms may vary by region. Full detailed information is available on our website, here: http://www.zyxel.com/support/warranty_information.shtml

Purchase Information

Zyxel Product Name:

Hardware Serial Number:

Date of Purchase:

(In certain countries, the warranty will be validated with seller's signature and stamp):

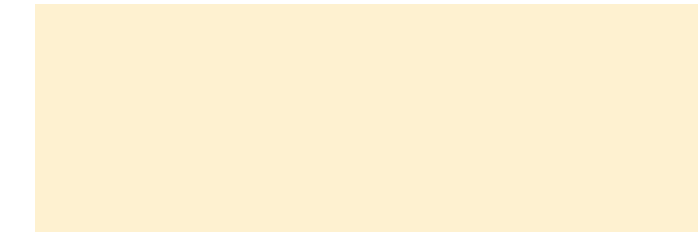

- EN** 1 Download and install the Zyxel ONE Connect app via the App Store, Play Store, or QR code on your Android or iOS devices.
2 Open the Zyxel ONE Connect app and follow the installation instructions.
- DK** 1 Hent og installer app'en Zyxel ONE Connect via App Store, Play Store eller QR-kode på din Android- eller iOS-enheder.
2 Åbn app'en Zyxel One Connect og følg installationsvejledningen.
- NO** 1 Last ned og installer appen Zyxel ONE Connect via App Store, Play Store eller QR-koden på dine Android- eller iOS-enheter.
2 Åpne appen Zyxel ONE Connect og følg installeringsinstruksjonene.
- FI** 1 Lataa ja asenna Zyxel ONE Connect -sovellus App Storesta, Play Storesta tai QR-koodin kautta Android- tai iOS-laitteellasi.
2 Avaa Zyxel ONE Connect -sovellus ja noudata asennusohjeita.
- SE** 1 Hämta och installera Zyxel ONE Connect app via App Store, Play Store eller QR-koden på din Android- eller iOS-enhet.
2 Öppna Zyxel ONE Connect-appen och följ installationsanvisningarna.

- EN** 1 Use an Ethernet cable to connect the NBG6604's blue WAN port to a broadband modem or router that has Internet access.
2 Use the included power adaptor to connect the power socket to a power outlet.
- DK** 1 Tilslut et bredbåndsmodem, der har internetadgang, til WAN-porten på NBG6604 med et Ethernet-kabel.
2 Brug den medfølgende strømadapter til at tilslutte strømstikket til en stikkontakt.
- NO** 1 Bruken Ethernet-kabel til å koble et bredbåndsmodem med internet-tilgang til den blå WAN-porten på NBG6604.
2 Bruk den medfølgende strømadapteren for å koble strømkontakten til strømuttak.
- FI** 1 Liitä laajakaistamodeemi (jossa on internet-yhteys) ethernet-kaapelilla NBG6604 -laitteen siniseen laajaverkkoporttiin (WAN).
2 Yhdistä virtapistoke pistorasiaan mukana toimitetulla virtasovittimella.
- SE** 1 Anslut ett bredbandsmodem (med internet-åtkomst) till den blå WAN-porten för NBG6604 med en Ethernet-kabel.
2 Använd den medföljande strömadaptern och anslut eluttaget till ett vägguttag.

- EN** 3-1 For iOS and other wireless devices, find the Wi-Fi name (SSID) and enter the Wi-Fi password.
3-2 Connect a computer to one yellow LAN port of the NBG6604.
- DK** 3-1 For iOS og andre trådløse enheder, find Wi-Fi-navnet (SSID) og indtast Wi-Fi-adgangskoden.
3-2 Tilslut en computer til en gul LAN-port på NBG6604.
- NO** 3-1 Med iOS og andre trådløse enheter må du finne Wi-Fi-navnet (SSID) og angi Wi-Fi-passordet.
3-2 Koble en datamaskin til en gul LAN-port på NBG6604.
- FI** 3-1 iOS:illa ja muilla langattomilla laitteilla etsi langattoman verkon nimi (SSID) verkkoluettelosta ja kirjoita verkon salasana.
3-2 Liitä tietokone NBG6604 -laitteen keltaiseen lähiverkkoporttiin (LAN).
- SE** 3-1 För iOS och andra trådlösa enheter söker du Wi-Fi-namnet (SSID) och anger Wi-Fi-lösenordet.
3-2 Anslut en dator till en gul LAN-port för NBG6604.

- EN** 4 Connect a computer to one yellow LAN port of the NBG6604.
Configure NBG6604
From the connected device, open a web browser and type <http://myrouter>. Enter **1234** as the password and click **Login**.
- DK** 4 Tilslut en computer til en gul LAN-port på NBG6604.
For at konfigurere din enhed
Åbn en webbrowser på den tilsluttede computer og indtast <http://myrouter>. Indtast **1234** som adgangskode, og klik på **Login**.
- NO** 4 Koble en datamaskin til en gul LAN-port på NBG6604.
Konfigurer enheten
Fra den tilkoblede enheten åpner du en nettleser og skriver inn <http://myrouter>. Angi **1234** som passord og klikk på **Logg inn**.
- FI** 4 Liitä tietokone NBG6604 -laitteen keltaiseen lähiverkkoporttiin (LAN).
Laitteen asetusten määrittäminen
Avaa selain verkkoon kytketyssä laitteessa ja kirjoita osoiteriville <http://myrouter>. Anna salasana **1234** ja valitse **Login** (Kirjautu sisään).
- SE** 4 Anslut en dator till en gul LAN-port för NBG6604.
Konfigurera enheten
Öppna en webbläsare från den anslutna enheten och skriv <http://myrouter>. Skriv in **1234** som lösenord och klicka på **Login** (Inloggning).

Support Information

Denmark ☎ + 49 3955 0785
✉ support@zyxel.dk

Norway ☎ + 47 22 80 61 80
✉ teknisk@zyxel.no

Finland ☎ + 358 9 4780 8411
✉ support@zyxel.fi

Sweden ☎ + 46 8 557 760 65
✉ support@zyxel.se

See the User's Guide at www.zyxel.com for more information, including customer support and safety warnings.

EU Importer
Zyxel Communications A/S
Generatorvej 8D, 2860 Søborg, Denmark.
<http://www.zyxel.dk>

US Importer
Zyxel Communications, Inc
1130 North Miller Street Anaheim, CA 92806-2001
<http://www.us.zyxel.com>

NBG6604

AC1200



ZYXEL ENGLISH | ČEŠTINA | MAGYAR | ROMÂNĂ | POLSKI | Slovenščina | slovenčina |

1

A



iOS, "App Store"
Android, "Play Store"

"Zyxel One Connect"



B

QR,

QR.

<http://www.zyxel.com/oneConnectApp/index.html>



2

Zyxel ONE Connect

2

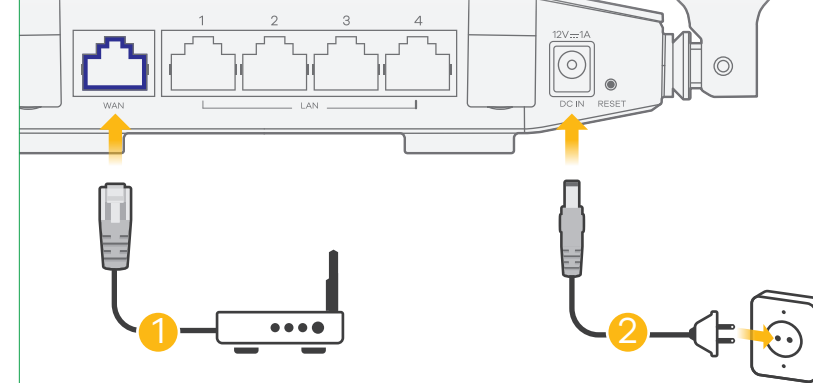

Power On 5G On 2.4G On

3-1

Wi-Fi



2.4G Wi-Fi Name (SSID)
Zyxelxxxxxx
5G Wi-Fi Name (SSID)
Zyxelxxxxx.speed
Wi-Fi Password
XXXXXXXXXXXX



3-2

Ethernet

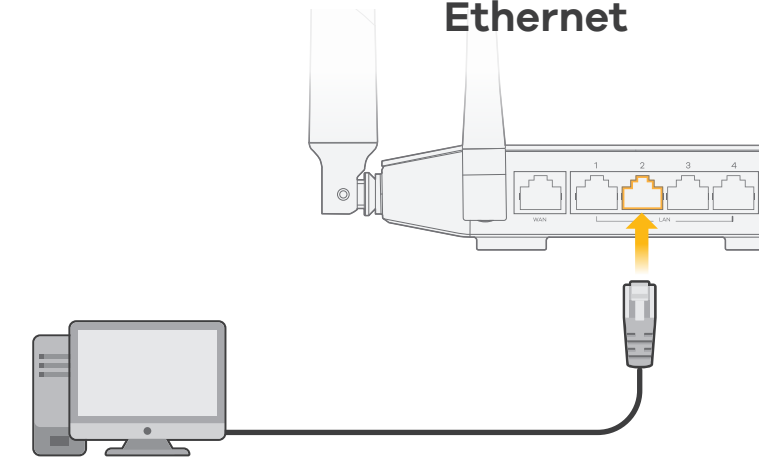

4

<http://myrouter>

Login Password: 1234

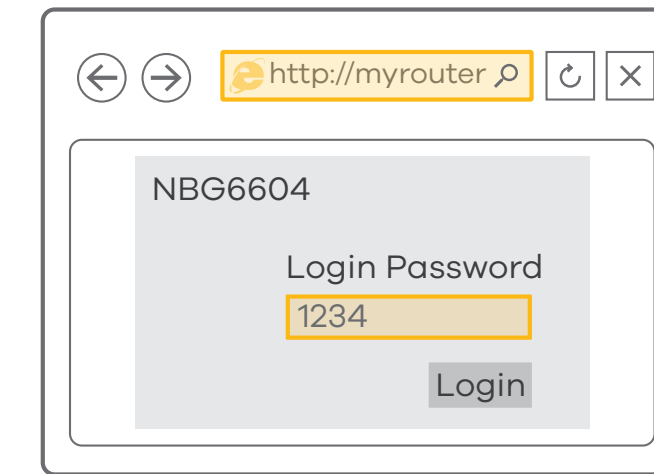

ZYXEL
Your Networking Ally



Warranty Card

Thank you for purchasing a Zyxel product. Zyxel has a reputation for delivering high quality, high performance products and services to our customers. We recommend that you now visit the Zyxel website and register your product online. This will mean you can receive the latest firmware, drivers and product related information. If you still have further questions or enquiries related to the product, please contact our subsidiaries worldwide. Please note that warranty terms may vary by region. Full detailed information is available on our website, here: http://www.zyxel.com/support/warranty_information.shtml

Purchase Information

Zyxel Product Name:
Hardware Serial Number:
Date of Purchase:
(In certain countries, the warranty will be validated with seller's signature and stamp):

- EN 1 Download and install the Zyxel ONE Connect app via the App Store, Play Store, or QR code on your Android or iOS devices. 2 Open the Zyxel ONE Connect app and follow the installation instructions.
- CZ 1 Do svého zařízení Android nebo iOS si z obchodů App Store, Play Store nebo přes QR kód stáhněte a nainstalujte aplikaci Zyxel ONE Connect. 2 Otevřete aplikaci Zyxel ONE Connect a postupujte podle instalačních pokynů.
- HU 1 Töltse le és telepítse a Zyxel ONE Connect alkalmazást az App Store vagy Play áruházból, vagy a QR-kódon keresztül iOS vagy Android eszközére. 2 Nyissa meg a Zyxel ONE Connect alkalmazást és kövesse a telepítési útmutatót.
- RO 1 Descărcați și instalați aplicația Zyxel ONE Connect din App Store, Play Store sau prin codul QR pe dispozitivele dvs. Android sau iOS. 2 Deschideți aplicația Zyxel ONE Connect și urmați instrucțiunile de instalare.
- PL 1 Pobierz i zainstaluj aplikację Zyxel ONE Connect na urządzeniu z systemem Android lub iOS, korzystając ze sklepu App Store, Play Store lub skanując kod QR. 2 Otwórz aplikację Zyxel ONE Connect i postępuj zgodnie z instrukcjami dotyczącymi instalacji.
- SL 1 Snemite in nameštite ap Poveži Zyxel ONE prek App Store, Play Store ali kode prepisa poizvedbe (QR) na svoj android ali naprave iOS. 2 Odprite ap Poveži Zyxel ONE in upoštevajte navodila za nameštitev.
- SK 1 Prevezmite a nainštalujte aplikáciu Zyxel ONE Connect prostredníctvom obchodu App Store, Play Store, prípadne kódu QR cez vaše zariadenie so systémom Android alebo iOS. 2 Otvorte aplikáciu Zyxel ONE Connect a postupujte podľa pokynov k inštalácii.
- RU 1 QR- Zyxel ONE Connect App Store Play Store Android iOS. 2 Zyxel ONE Connect

- EN 1 Use an Ethernet cable to connect the NBG6604's blue WAN port to a broadband modem or router that has Internet access. 2 Use the included power adaptor to connect the power socket to a power outlet.
- CZ 1 Propojte širokopásmový modem nebo směrovač, který má přístup k Internetu, se zařízením NBG6604 prostřednictvím ethernetové kabelu, který zasuněte do jeho modrého portu WAN. 2 K připojení do elektrické sítě použijte přiložený adaptér, jehož konektor zasuněte do zdířky napájení v zařízení.
- HU 1 Csatlakoztasson egy internetkapcsolattal rendelkező szélessávú modemet vagy útválasztót az NBG6604 kék WAN portjához egy Ethernet kábellel. 2 A mellékelt elektromos hálózati adapterrel csatlakoztassa a tápsatlakozót egy elektromos aljzathoz.
- RO 1 Conectați un modem sau un router de bandă largă, care are acces la Internet la portul WAN albastru al NBG6604 cu un cablu Ethernet. 2 Utilizați adaptorul de alimentare inclus pentru a conecta mufa de alimentare la o priză.
- PL 1 Podłącz modem szerokopasmowy lub router z dostępem do Internetu do gniazda WAN urządzenia NBG6604 za pomocą kabla Ethernet. 2 Użyj dołączonego do zestawu zasilacza w celu podłączenia wejścia zasilania do gniazdka.
- SL 1 Z ethernetnim kablom povežite širokopasovni modem ali usmerjevalnik, ki ima internetni dostop do modrih vrat WAN na enoti NBG6604. 2 S priloženim napajalnim vmesnikom vklopite napajalni vtič v električno vtičnico.
- SK 1 Pripojte širokopásmový modem alebo smerovač, ktorý má prístup k internetu, k modrému portu WAN zariadenia NBG6604; použite na to kábel siete Ethernet. 2 Pomocou dodaného sieťového adaptéra pripojte napájaciú zásuvku k elektrickej zásuvke.
- RU 1 Ethernet WAN- NBG6604 2 Power

- EN 3-1 For iOS and other wireless devices, find the Wi-Fi name (SSID) and enter the Wi-Fi password. 3-2 Connect a computer to one yellow LAN port of the NBG6604.
- CZ 3-1 V zařízeních iOS a v jiných bezdrátových zařízeních vyhledejte název sítě Wi-Fi (SSID) a zadejte její heslo. 3-2 Do žlutého portu LAN zařízení NBG6604 zapojte počítač.
- HU 3-1 iOS vagy más vezeték nélküli eszközök esetén keresse meg a Wi-Fi hálózat nevét (SSID), és adja meg a Wi-Fi jelszavát. 3-2 Csatlakoztasson egy számítógépet az NBG6604 sárga LAN portjához.
- RO 3-1 Pentru dispozitivele iOS și alte dispozitive fără fir, căutați denumirea Wi-Fi (SSID) și introduceți parola Wi-Fi. 3-2 Conectați un computer la un port LAN galben al NBG6604.
- PL 3-1 W przypadku urządzeń z systemem iOS oraz innych urządzeń bezprzewodowych odszukaj nazwę Wi-Fi (SSID) i wprowadź hasło Wi-Fi. 3-2 Podłącz komputer do żółtego gniazda LAN urządzenia NBG6604.
- SL 3-1 Za naprave iOS in druge brezžične naprave poiščite ime Wi-Fi (SSID) in vnesite geslo Wi-Fi. 3-2 Priključite računalnik na rumena vrata LAN na enoti NBG6604.
- SK 3-1 V prípade systému iOS a ostatných bezdrôtových zariadení nájdite názov siete Wi-Fi (SSID) a zadajte heslo pre sieť Wi-Fi. 3-2 Pripojte počítač k jednému žltému portu LAN zariadenia NBG6604.
- RU 3-1 c iOS Wi-Fi SSID 3-2 Wi-Fi LAN- NBG6604

- EN 4 Connect a computer to one yellow LAN port of the NBG6604. Configure NBG6604. From the connected device, open a web browser and type <http://myrouter>. Enter 1234 as the password and click Login.
- CZ 4 Do žlutého portu LAN zařízení NBG6604 zapojte počítač. Konfigurace zařízení. V připojeném počítači otevřete webový prohlížeč a zadejte <http://myrouter>. Zadejte 1234 jako heslo a klikněte na Login (Přihlásit se).
- HU 4 Csatlakoztasson egy számítógépet az NBG6604 sárga LAN portjához. Eszközbeállítás. A csatlakoztatott eszközön nyisson meg egy internet böngészőt, és írja be a <http://myrouter> címet. Írja be az 1234 jelszót, és kattintson a Login (bejelentkezés) gombra.
- RO 4 Conectați un computer la un port LAN galben al NBG6604. Configurați dispozitivul dvs. Deschideți un browser web pe dispozitivul conectat și tastați <http://myrouter>. Introduceți 1234 ca parolă și faceți clic pe Login.
- PL 4 Podłącz komputer do żółtego gniazda LAN urządzenia NBG6604. Konfiguracja urządzenia. W podłączonym urządzeniu otwórz przeglądarkę i wpisz <http://myrouter>. Wprowadź 1234 jako hasło i kliknij Login (Zaloguj).
- SL 4 Priključite računalnik na rumena vrata LAN na enoti NBG6604. Konfiguriraj svojo napravo. S povezane naprave odprite spletni brskalnik in vanj vtipkajte <http://myrouter>. Vtipkajte 1234 pod geslo in kliknite Prijava.
- SK 4 Pripojte počítač k jednému žltému portu LAN zariadenia NBG6604. Konfigurácia vášho zariadenia. V pripojenom zariadení otvorte webový prehliadač a napíšte <http://myrouter>. Ako heslo zadajte 1234 a kliknite na Login (Prihlásiť sa).
- RU 4 LAN- NBG6604 1234 Login. <http://myrouter>.

Support Information

- Czech + 420 241 774 665 support@cz.zyxel.com
- Slovakia + 421 220 861 848 support@sk.zyxel.com
- Hungary + 36 1 848 0690 support@zyxel.hu
- Bulgaria support@zyxel.bg
- Romania info@ro.zyxel.com
- Poland + 48 22 652 16 26 support@pl.zyxel.com

See the User's Guide at www.zyxel.com for more information, including customer support and safety warnings.

EU Importer
Zyxel Communications A/S
Generatorvej 8D, 2860 Søborg, Denmark.
<http://www.zyxel.dk>

US Importer
Zyxel Communications, Inc
1130 North Miller Street Anaheim, CA 92806-2001
<http://www.us.zyxel.com>

Quick Start Guide

NBG6604

AC1200 Dual-Band Wireless Router



ZYXEL ENGLISH | ภาษาไทย | 繁體中文

Option 1 Setup with Your Mobile Device

Step 1

Method A

Launch the app store on your mobile device.

On iOS devices this is called the "App Store"

On Android devices it is called the "Play Store"

Search for "**Zyxel One Connect**"



Method B

If your phone has a QR code scanner, scan the following QR code.

Alternatively, you can visit the following link from the web browser on your mobile device:

<http://www.zyxel.com/oneConnectApp/index.html>



Step 2

Open the Zyxel ONE Connect app and follow the installation instructions.

Option 2 Setup Using Your Computer

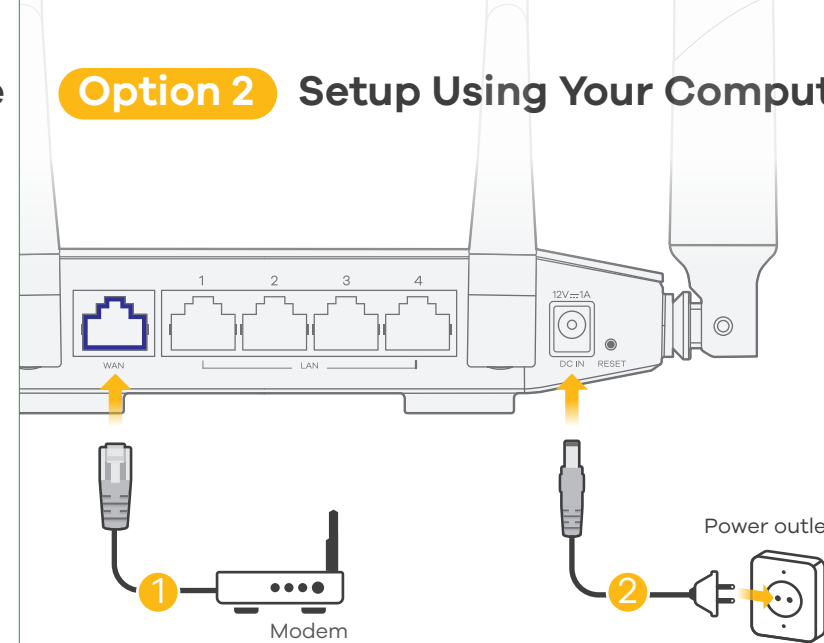

Check the LEDs

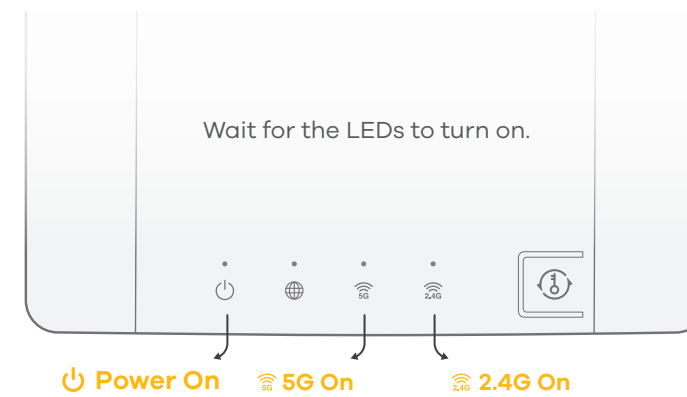

EN ① Use an Ethernet cable to connect the NBG6604's blue WAN port to a broadband modem or router that has Internet access.

② Use the included power adaptor to connect the power socket to a power outlet.

TH ① เชื่อมต่อกับโมเด็มหรือเราเตอร์อินเทอร์เน็ต, ที่เข้าถึงอินเทอร์เน็ตได้ผ่านทางพอร์ต WAN สีฟ้าของ NBG6604 ด้วยสายเคเบิ้ลอีเทอร์เน็ต

② ใช้อะแดปเตอร์ไฟที่มีให้เพื่อเชื่อมต่อด้านเสียบไฟกับปลั๊กไฟ

TW ① 將您的寬頻數據機使用網路線連接到 NBG6604 藍色網路孔 (WAN), 以便稍後進行網路線連接設定。

② 將包裝內附的電源變壓器一端連接至 NBG6617 的電源孔, 另一端接到電源插座上。

3-1 Wi-Fi Connection



2.4G Wi-Fi Name (SSID)
ZyxeIxxxxxx
5G Wi-Fi Name (SSID)
ZyxeIxxxxx.speed
Wi-Fi Password
XXXXXXXXXXXX



3-2 Ethernet Cable Connection

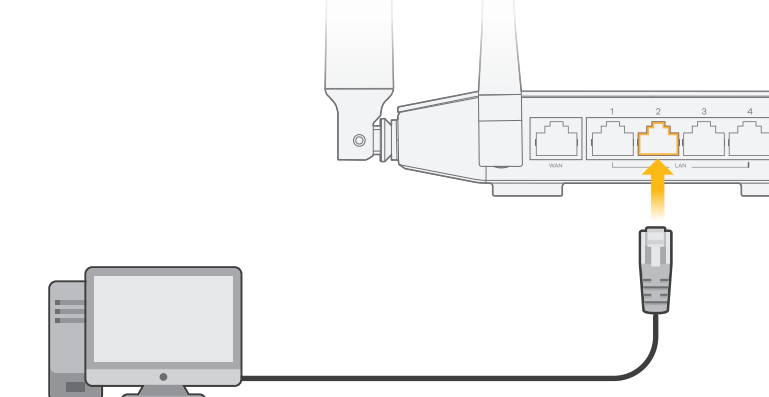

EN ③-1 For iOS and other wireless devices, find the Wi-Fi name (SSID) and enter the Wi-Fi password.

③-2 Connect a computer to one yellow LAN port of the NBG6604.

TH ③-1 สำหรับ iOS และอุปกรณ์ไร้สายอื่นๆ ค้นหาชื่อ Wi-Fi (SSID) และป้อนรหัสผ่าน Wi-Fi

③-2 เชื่อมต่อคอมพิวเตอร์กับพอร์ต LAN สีเหลืองไปยัง NBG6604

TW ③-1 如為 iOS 和其他無線裝置, 請找出 Wi-Fi 名稱 (SSID) 並輸入 Wi-Fi 密碼。

③-2 若您要使用有線網路, 請用黃色網路線連接電腦與 NBG6617 黃色網路孔 (LAN)。

4 Configure Your Device

<http://myrouter>

Login Password: **1234**
(default)

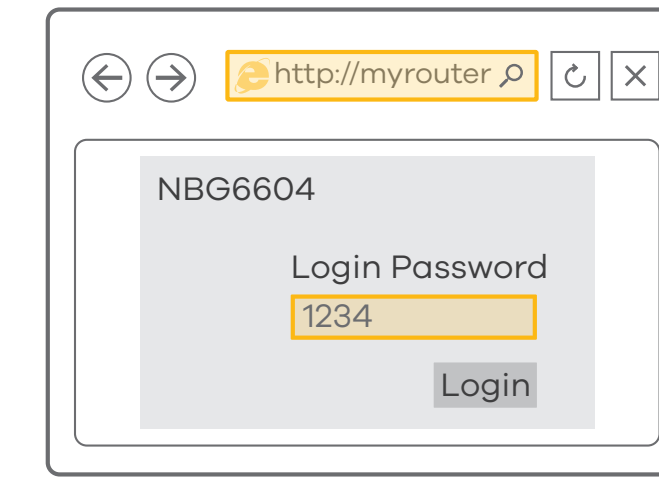

EN ④ Connect a computer to one yellow LAN port of the NBG6604.

Configure NBG6604
From the connected device, open a web browser and type <http://myrouter>. Enter **1234** as the password and click **Login**.

TH ④ เชื่อมต่อคอมพิวเตอร์กับพอร์ต LAN สีเหลืองไปยัง NBG6604

การกำหนดค่าอุปกรณ์ของคุณ

จากอุปกรณ์ที่เชื่อมต่อ เปิดเว็บเบราว์เซอร์และพิมพ์ <http://myrouter> ป้อนหมายเลข **1234** ที่เป็นรหัสผ่านและคลิกที่ล็อกอิน

TW ④ 若您要使用有線網路, 請用黃色網路線連接電腦與 NBG6617 黃色網路孔 (LAN)。

設定 NBG6604
在已連接的無線裝置或電腦上, 開啟瀏覽器, 輸入 <http://myrouter>, 並使用預設密碼 **1234** 登入 NBG6604。

ZYXEL

Your Networking Ally

Warranty Card



Thank you for purchasing a Zyxel product. Zyxel has a reputation for delivering high quality, high performance products and services to our customers. We recommend that you now visit the Zyxel website and register your product online. This will mean you can receive the latest firmware, drivers and product related information. If you still have further questions or enquiries related to the product, please contact our subsidiaries worldwide. Please note that warranty terms may vary by region. Full detailed information is available on our website, here: http://www.zyxel.com/support/warranty_information.shtml

Purchase Information

Zyxel Product Name:

Hardware Serial Number:

Date of Purchase:

(In certain countries, the warranty will be validated with seller's signature and stamp):

Support Information

Thailand ☎ + 66 2832 0600
✉ support@zyxel.co.th

Taiwan ☎ + 886 800 500 550
✉ retail@zyxel.com.tw

See the User's Guide at www.zyxel.com for more information, including customer support and safety warnings.

EU Importer
Zyxel Communications A/S
Generatorvej 8D, 2860 Søborg, Denmark.
<http://www.zyxel.dk>

US Importer
Zyxel Communications, Inc
1130 North Miller Street Anaheim, CA 92806-2001
<http://www.us.zyxel.com>