



АРМИЯ РОССИИ®

КОНСТРУКТОР

1386 ДЕТАЛЕЙ

# БОЕВОЙ ТАНК

6+



ИНСТРУКЦИЯ ПО СБОРКЕ





**x7**

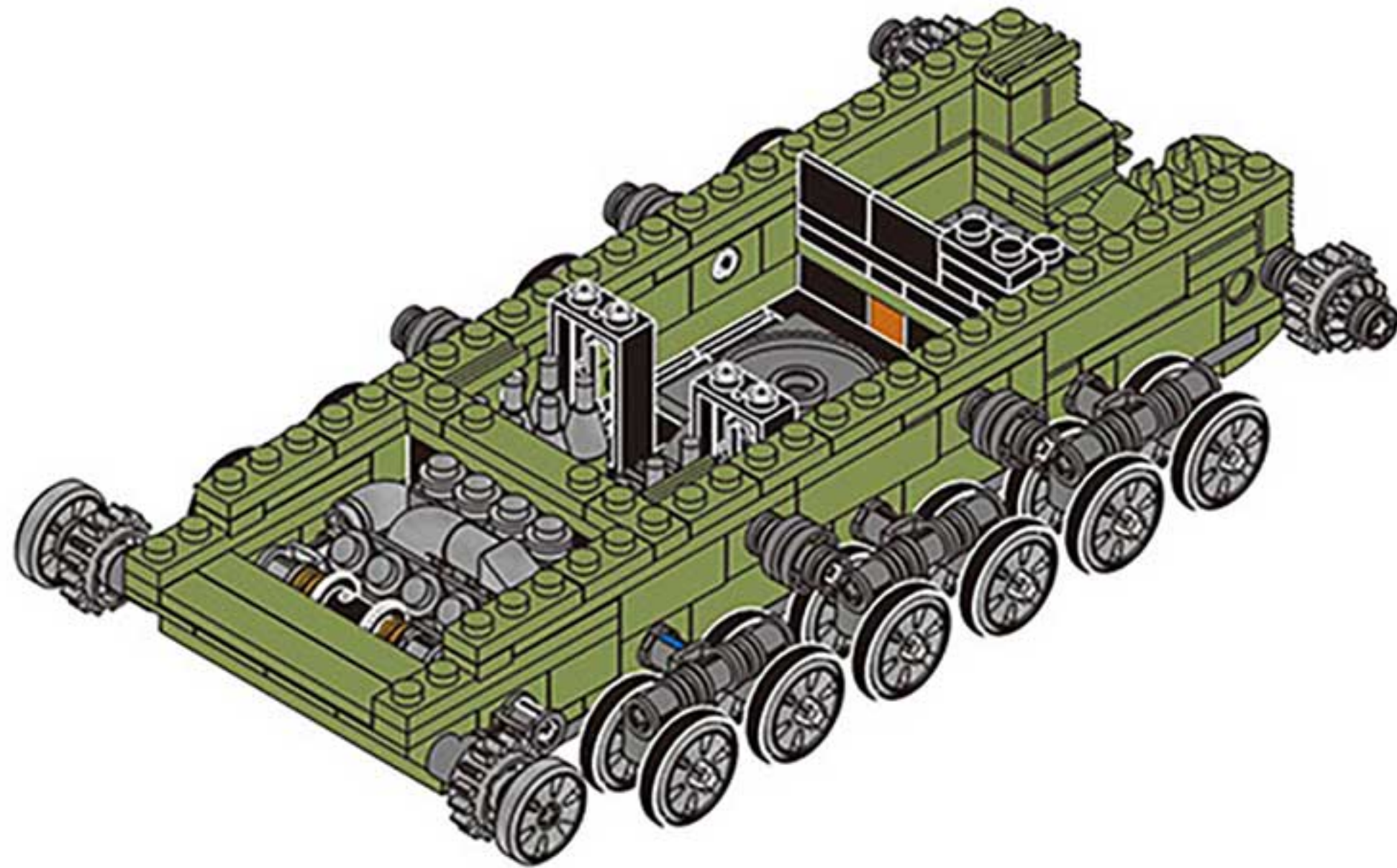

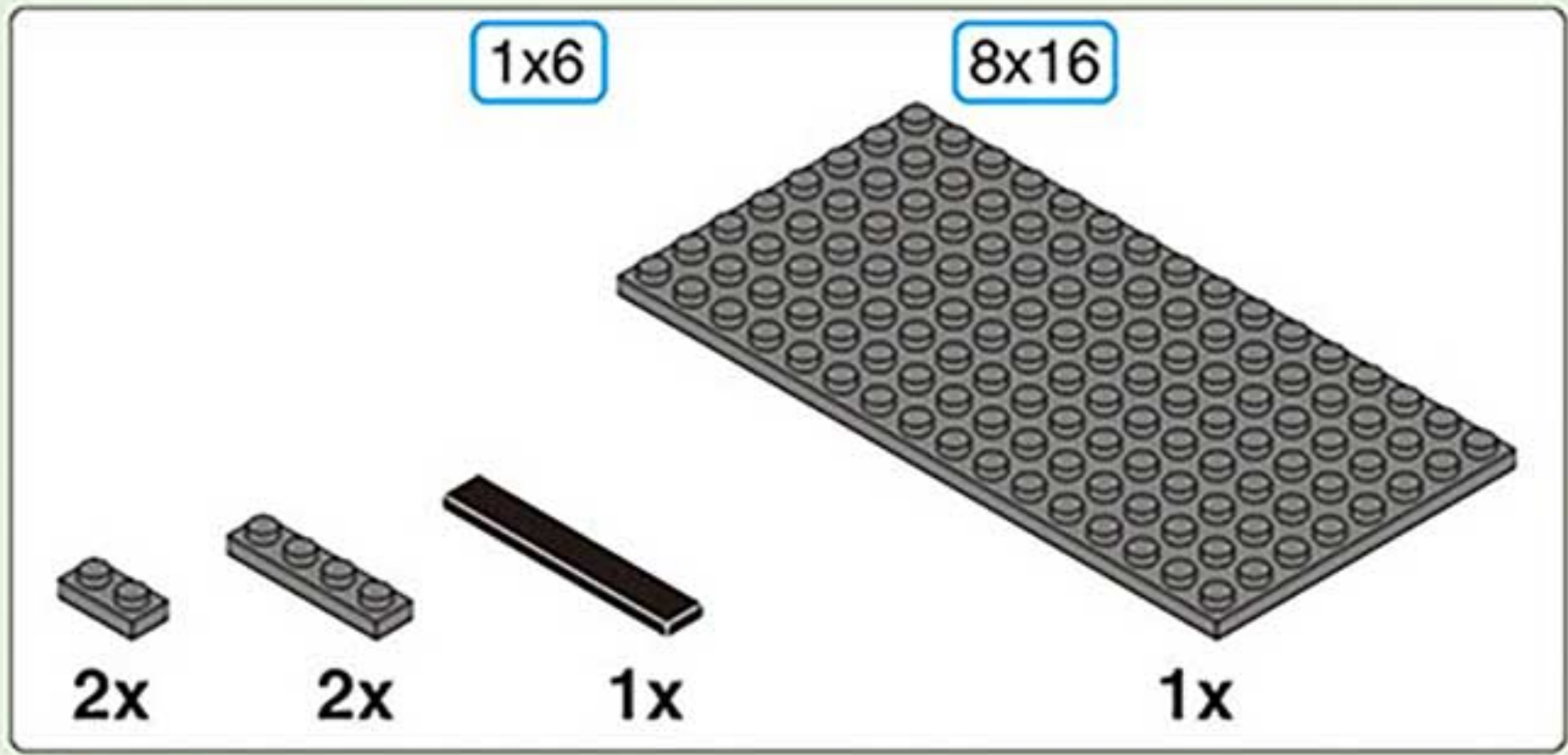

1-1

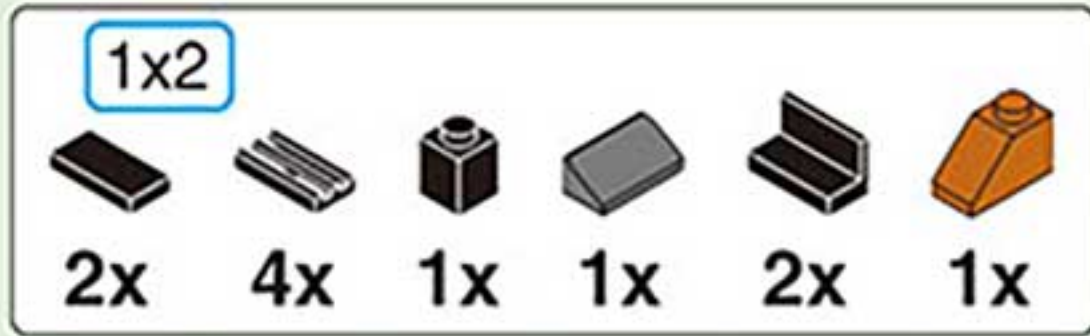
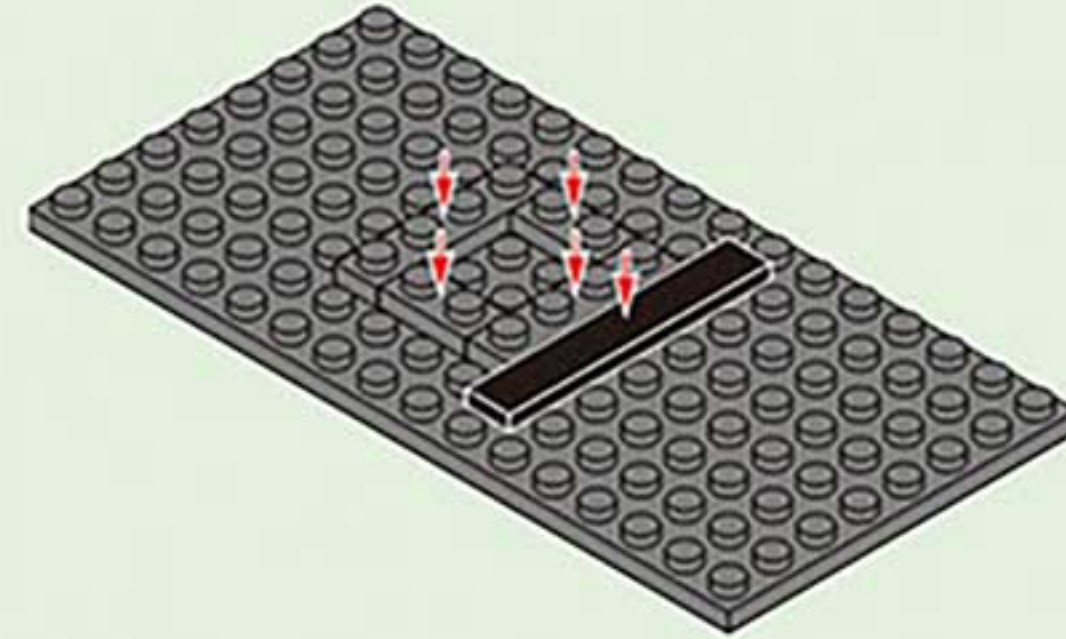

1-2

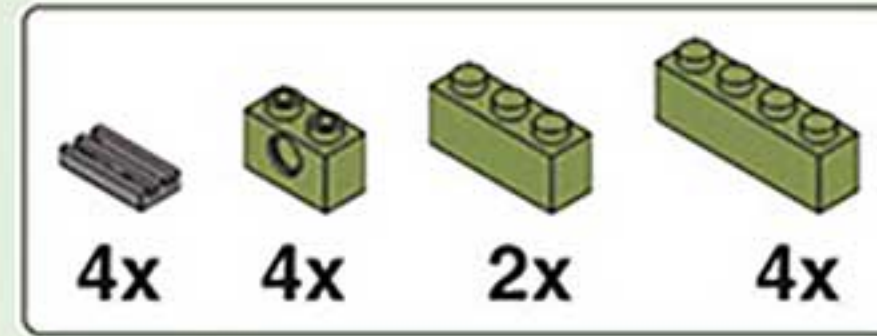
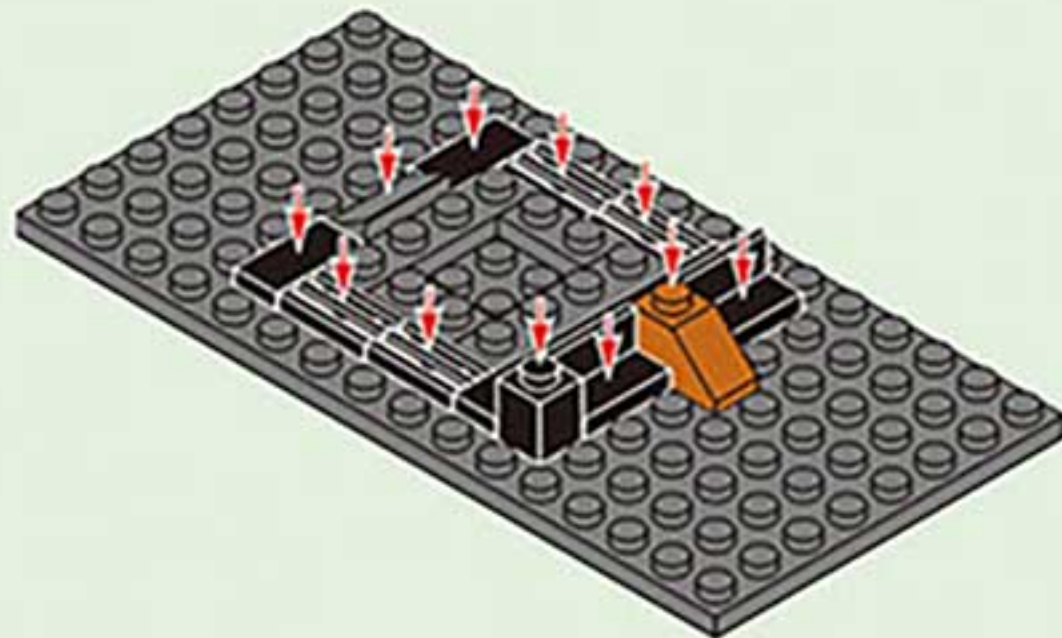

1-3

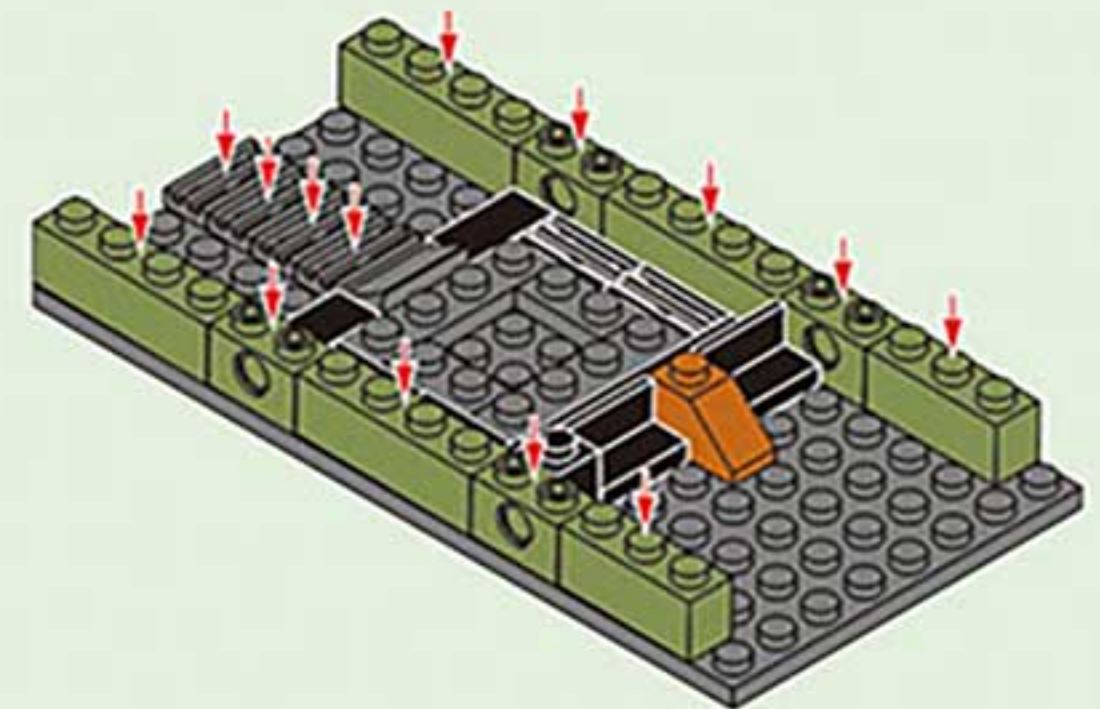

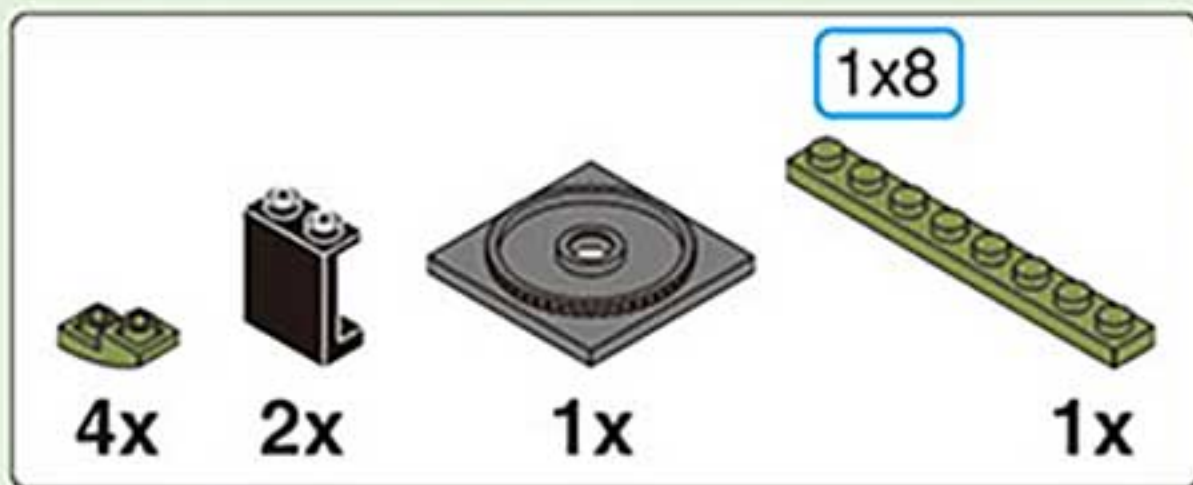

1-4

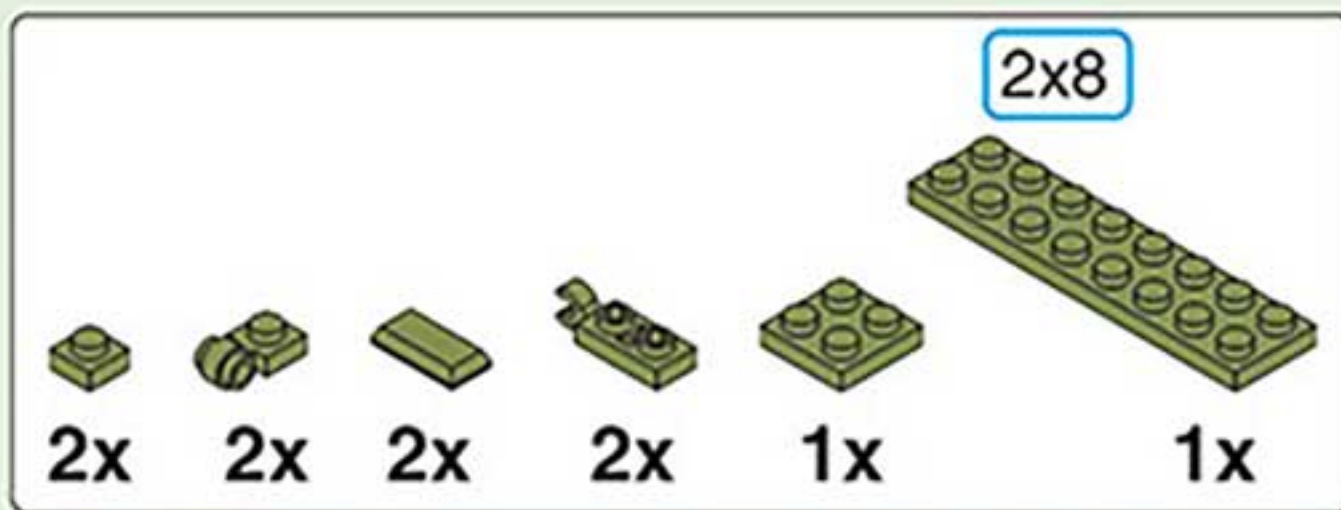
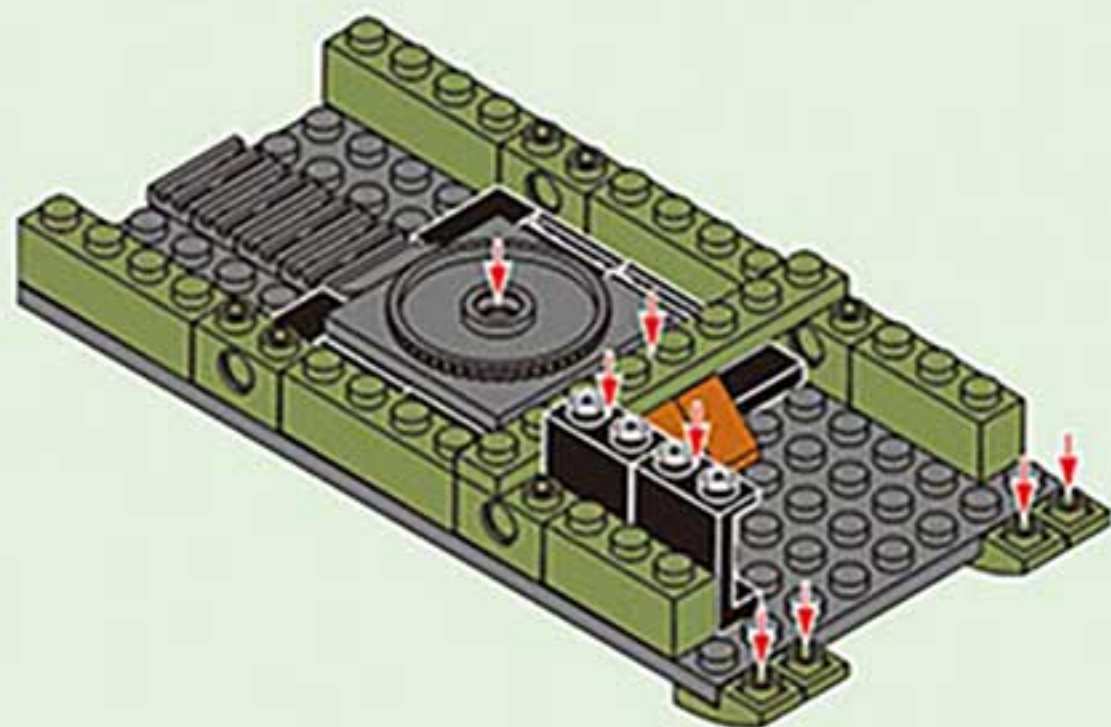

1-5

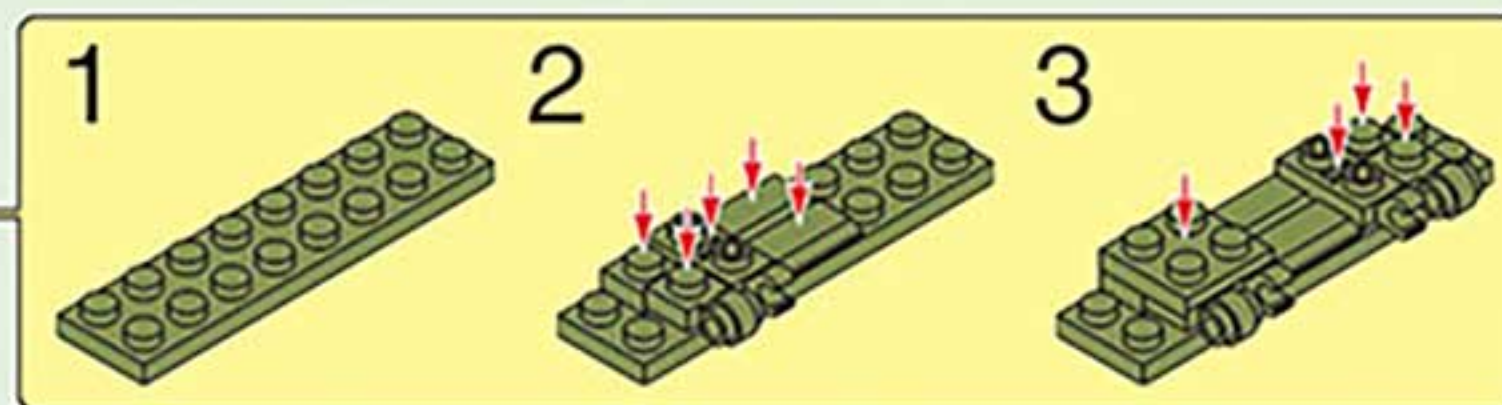
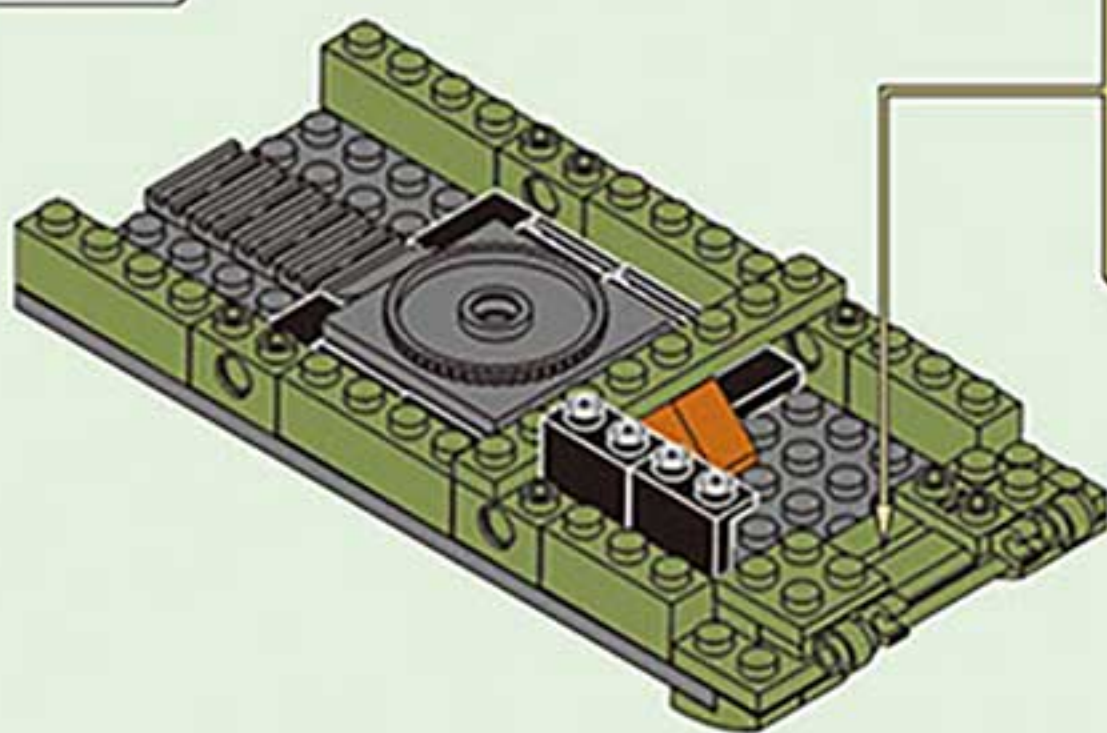

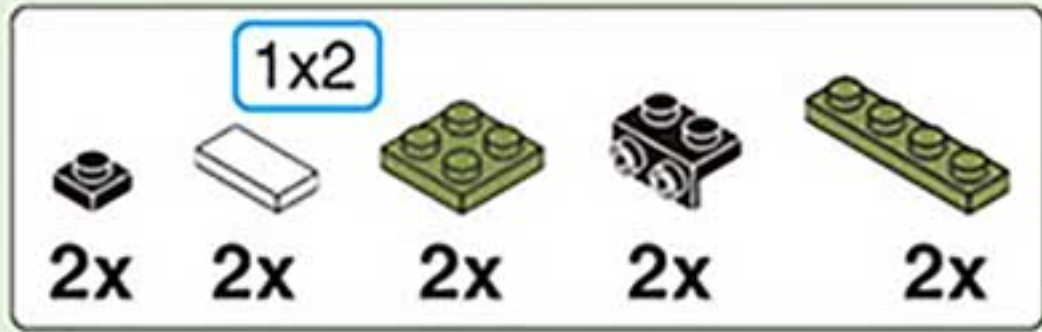

1-6

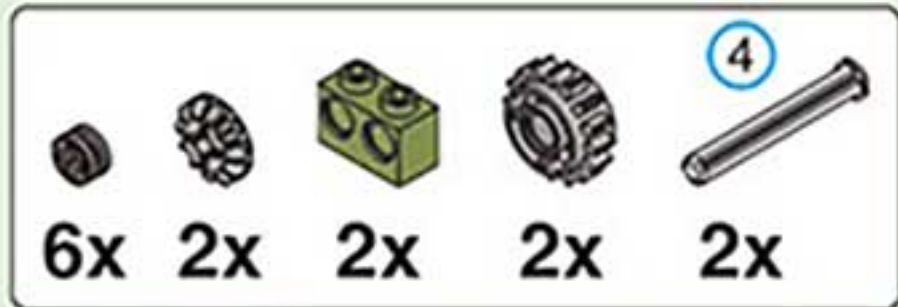
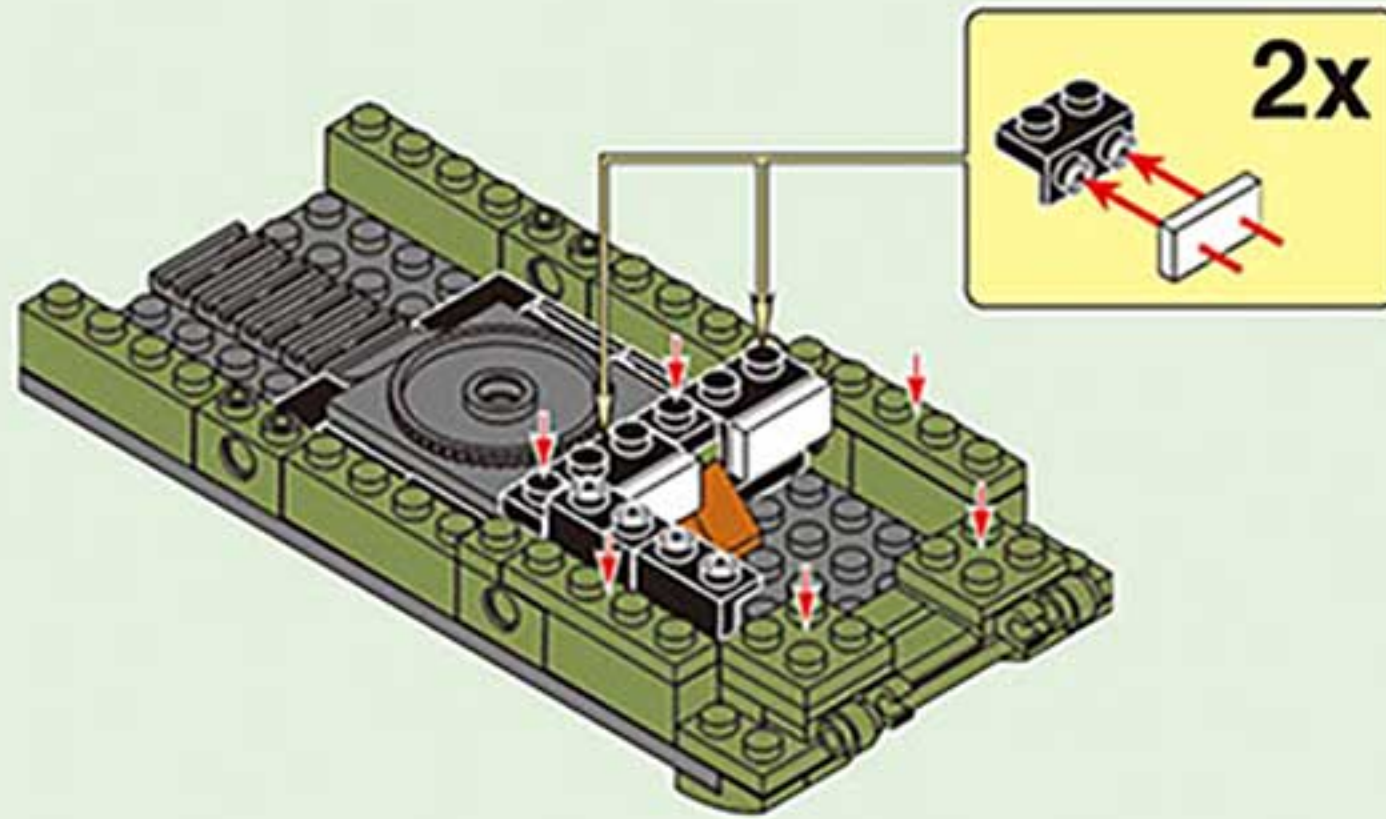

1-7 1:1 4

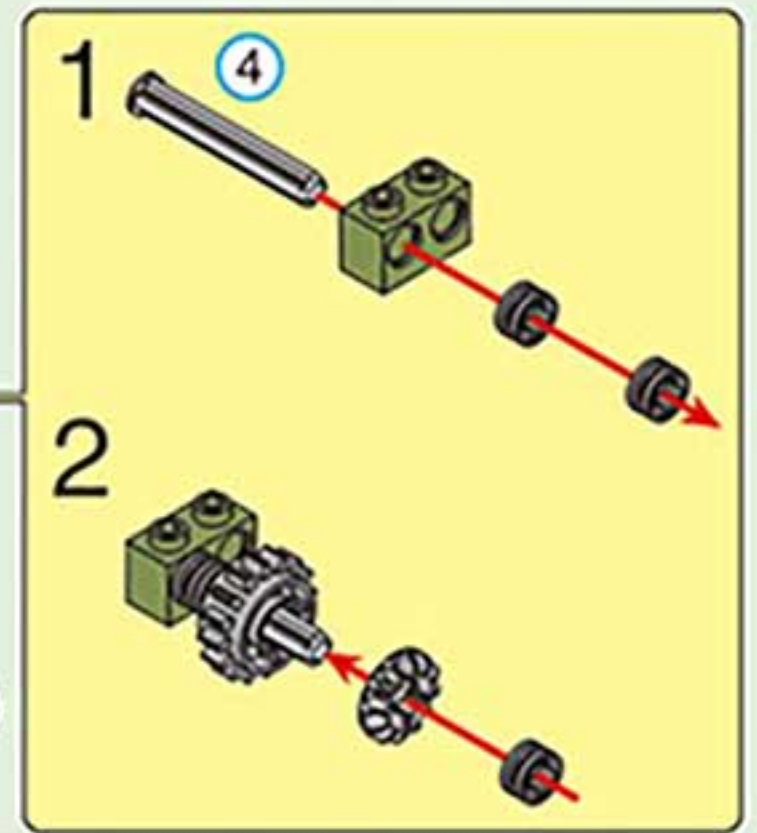
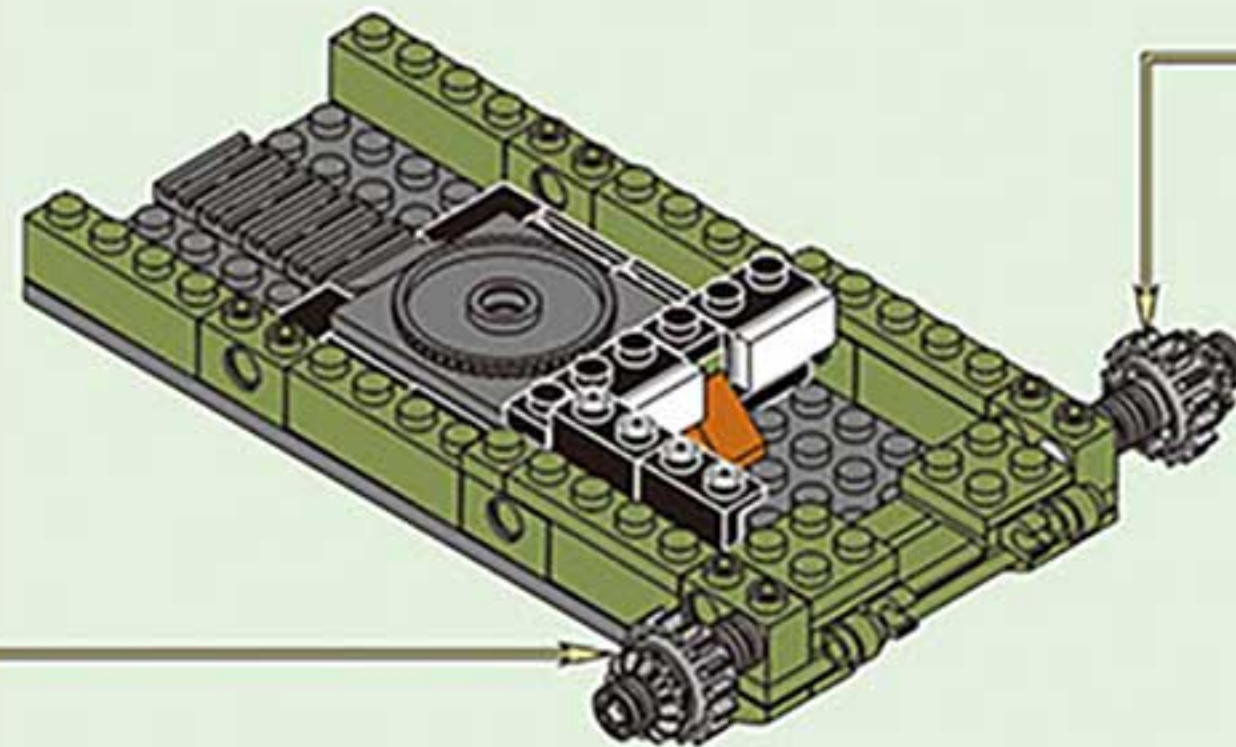
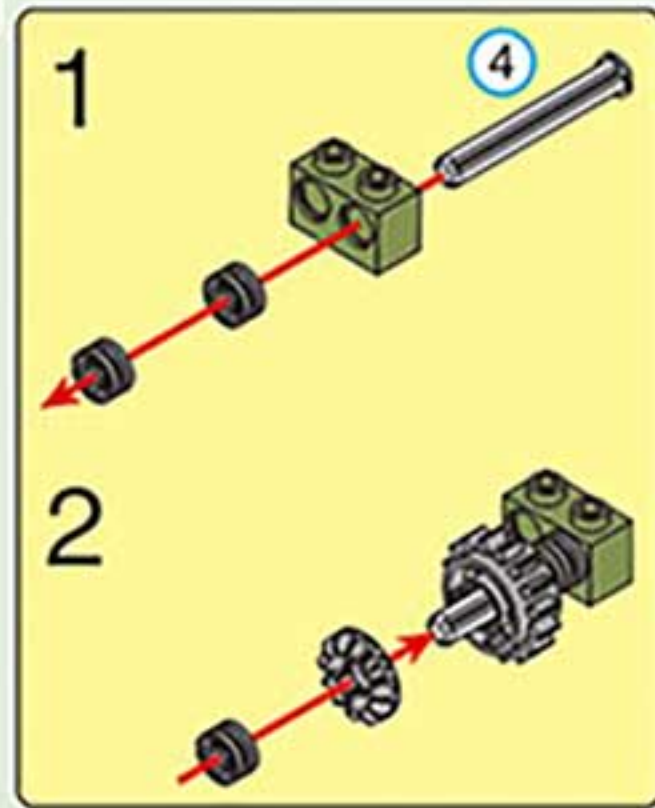



1-8

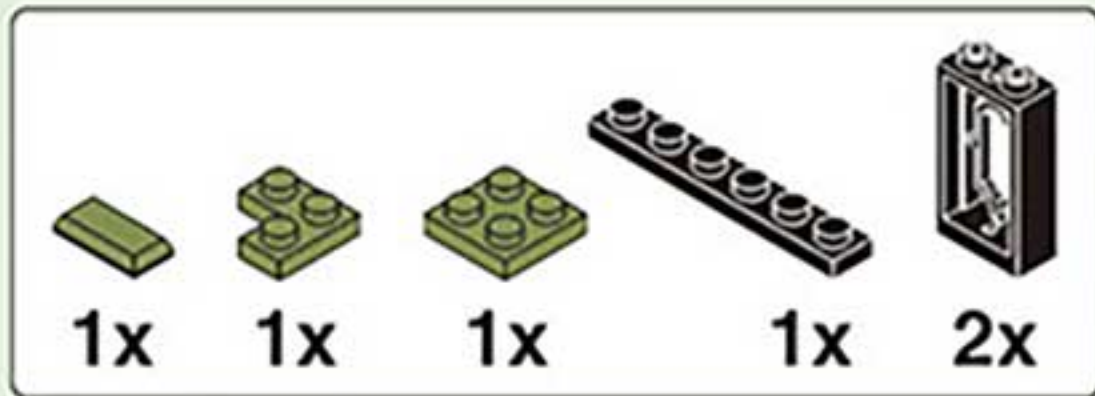
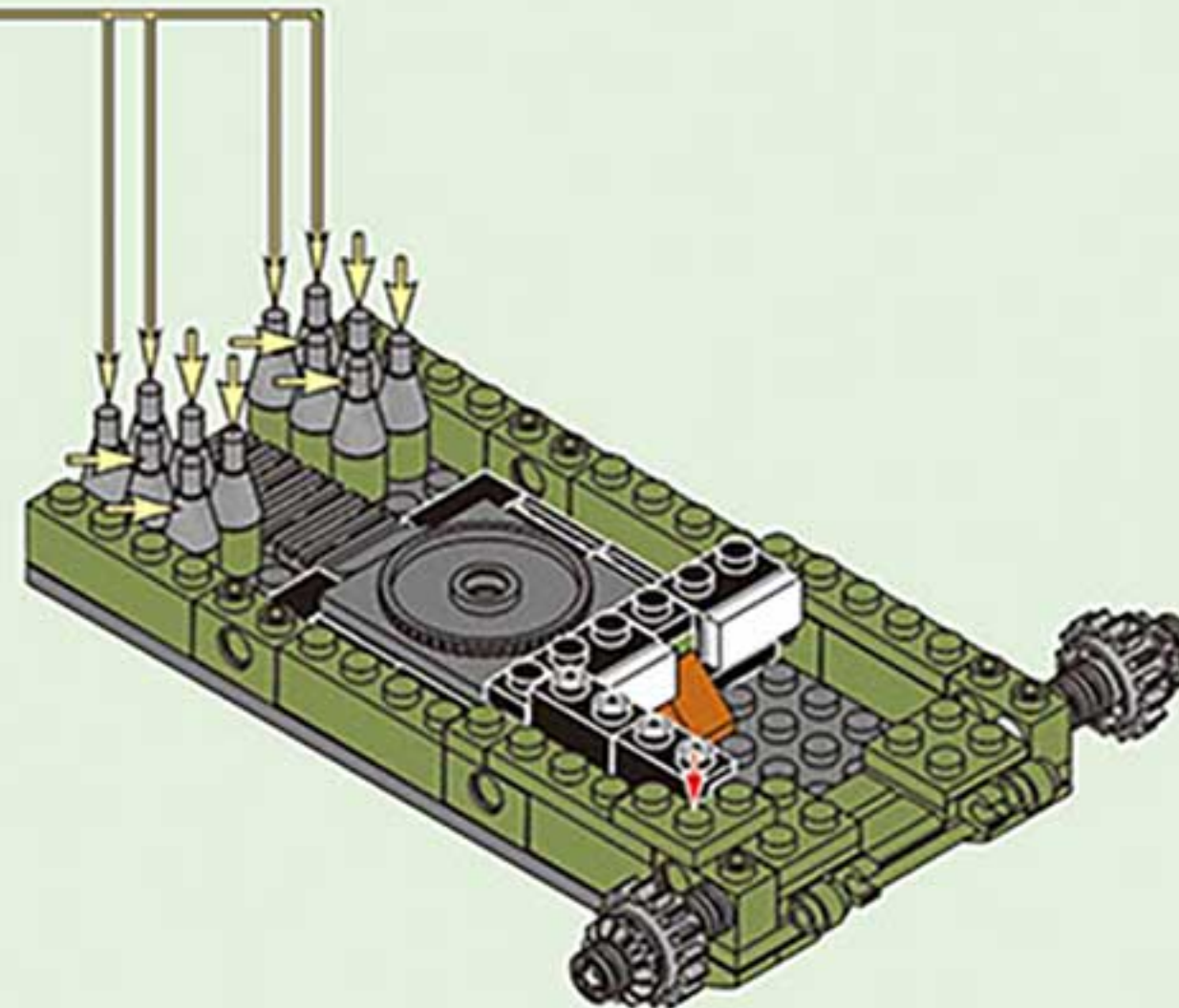
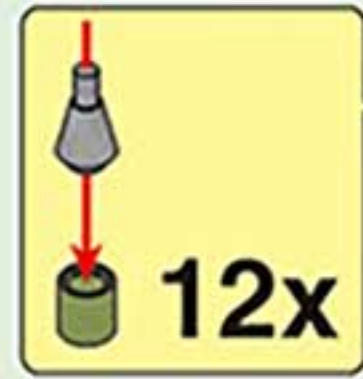

1-9

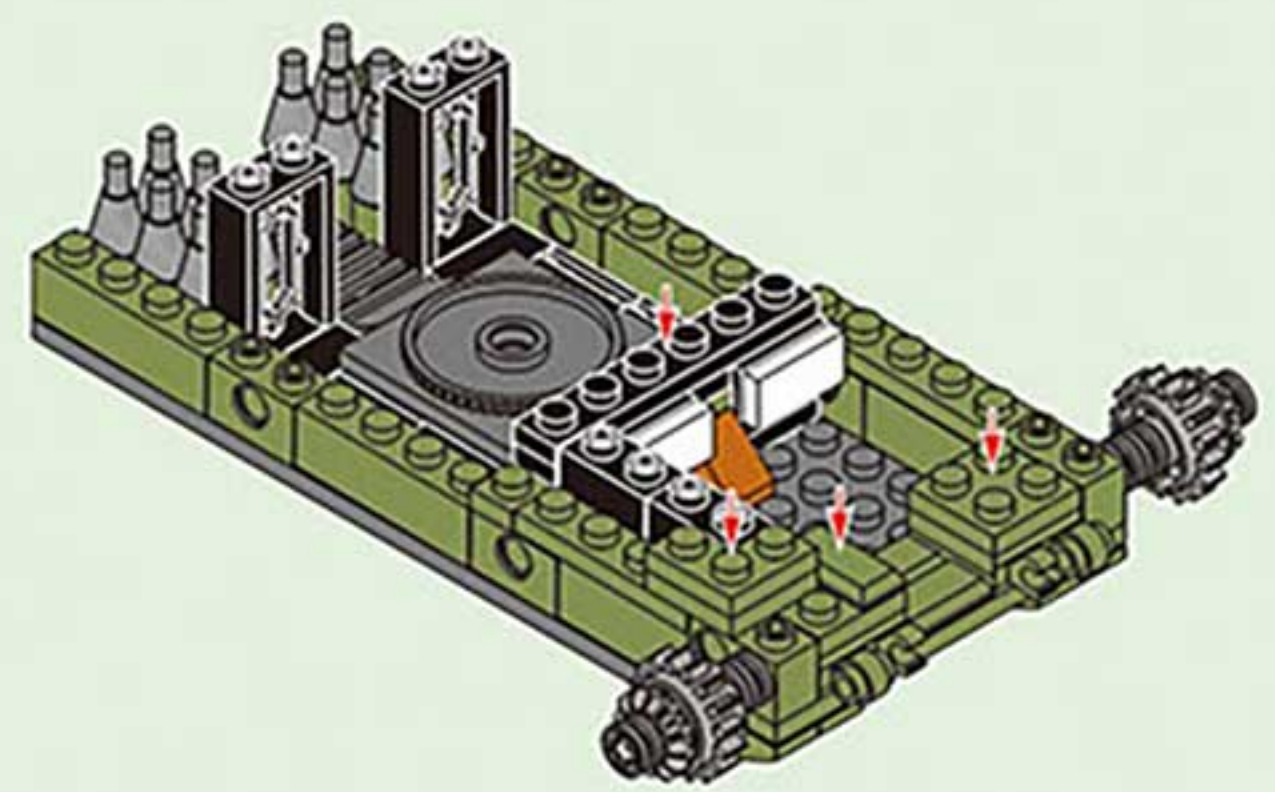

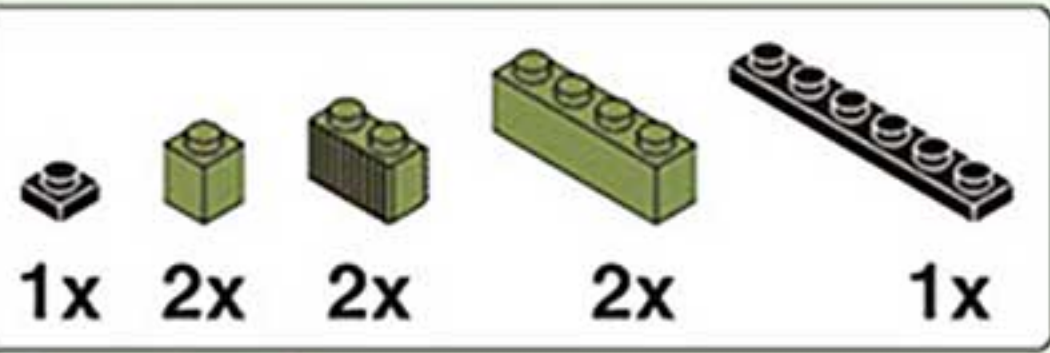

1-10

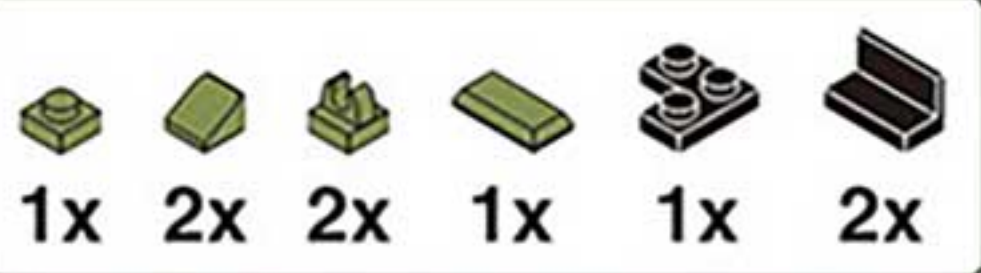
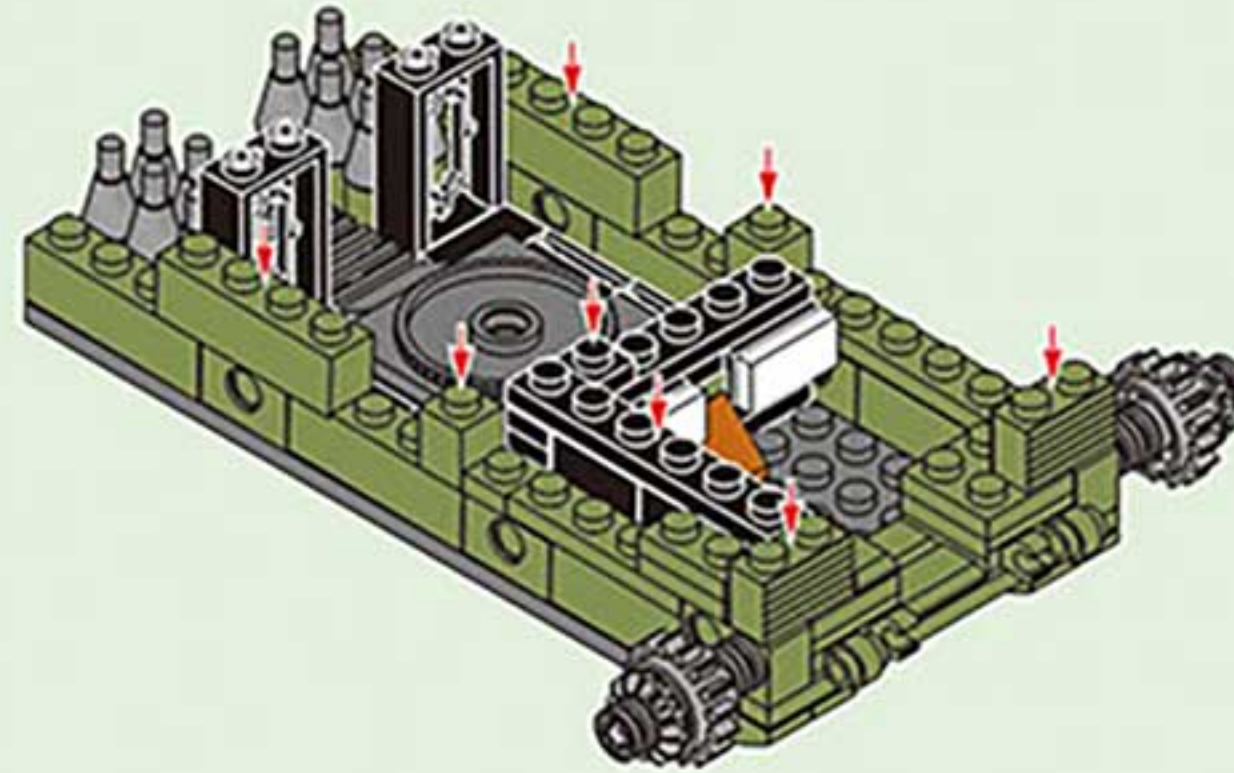

1-11

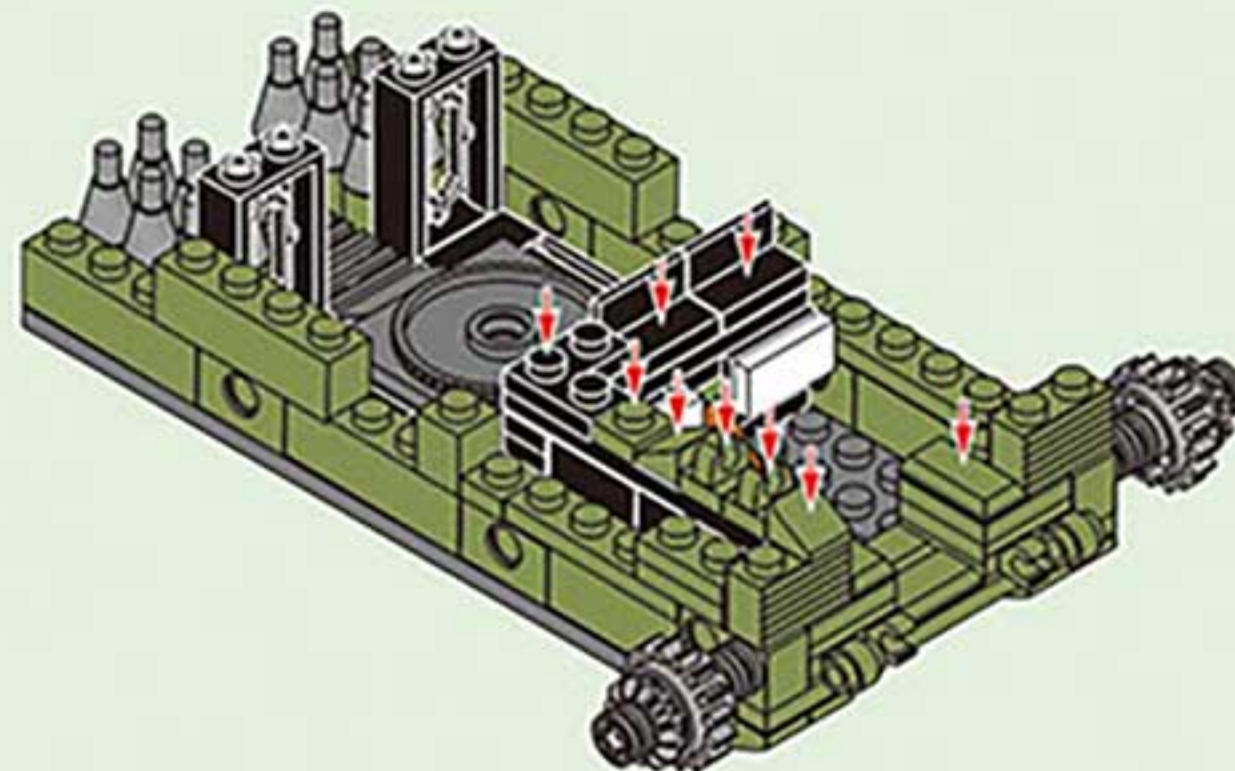



1-12

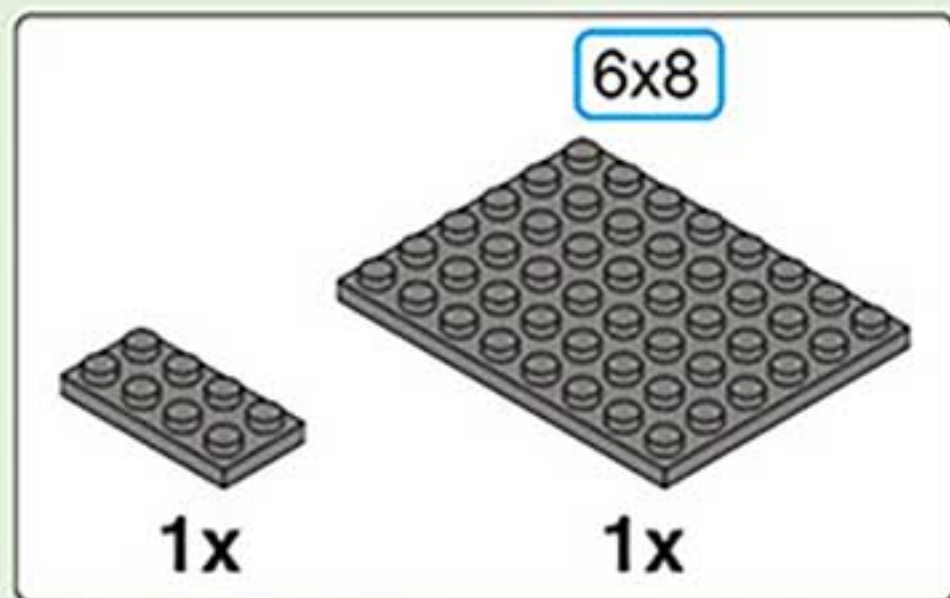
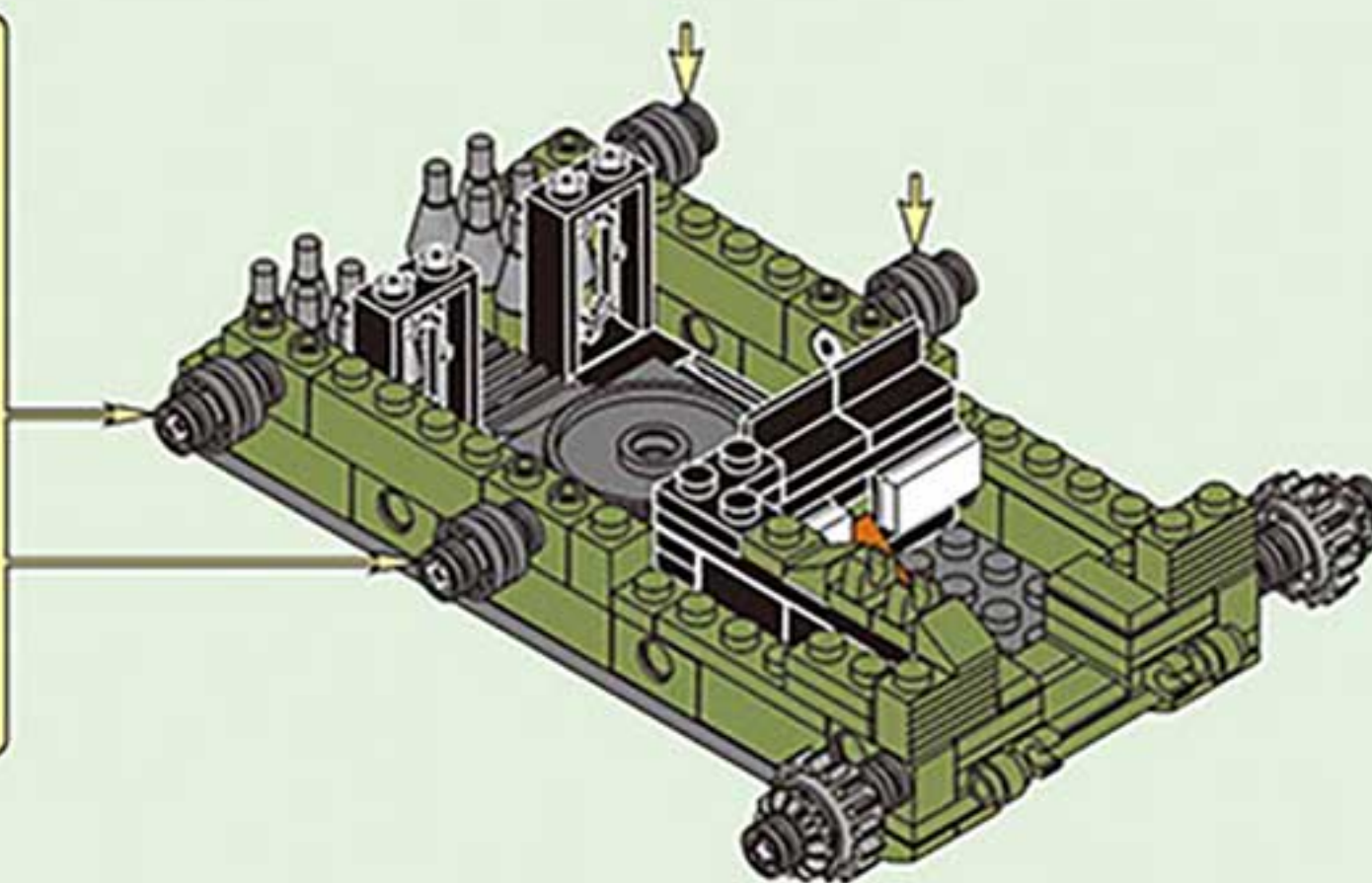
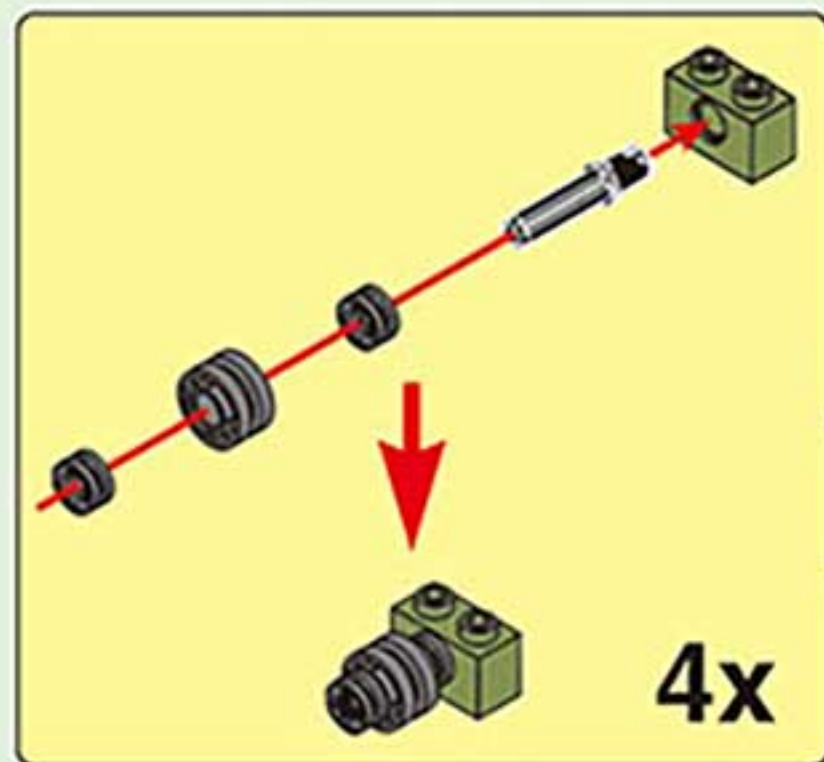

1-13.1

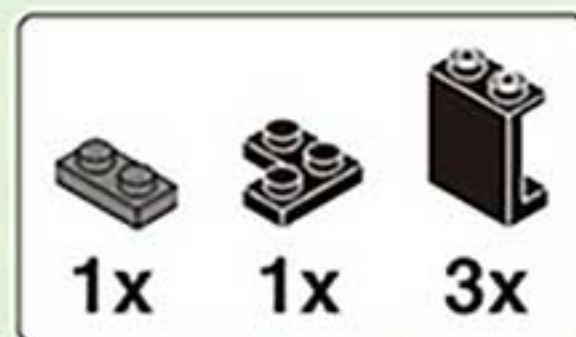

1-13.2

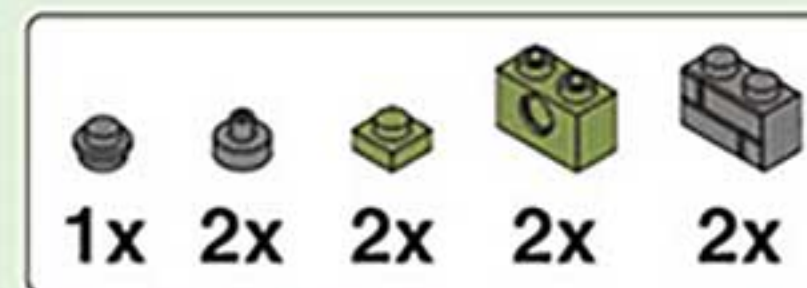
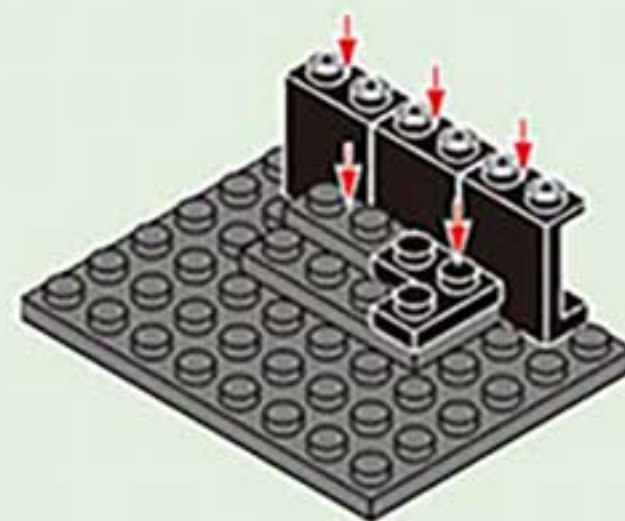

1-13.3

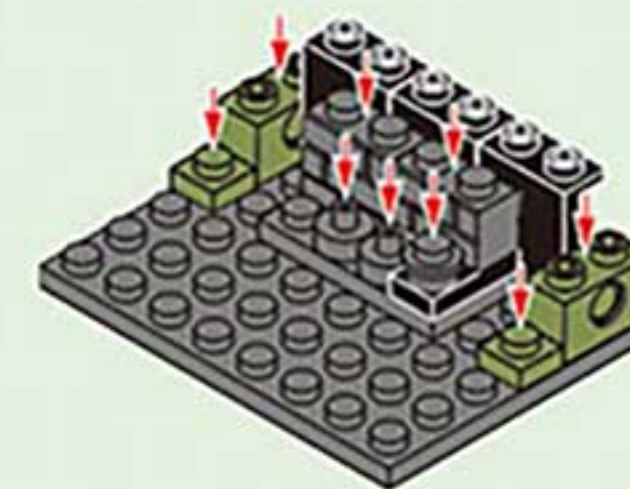

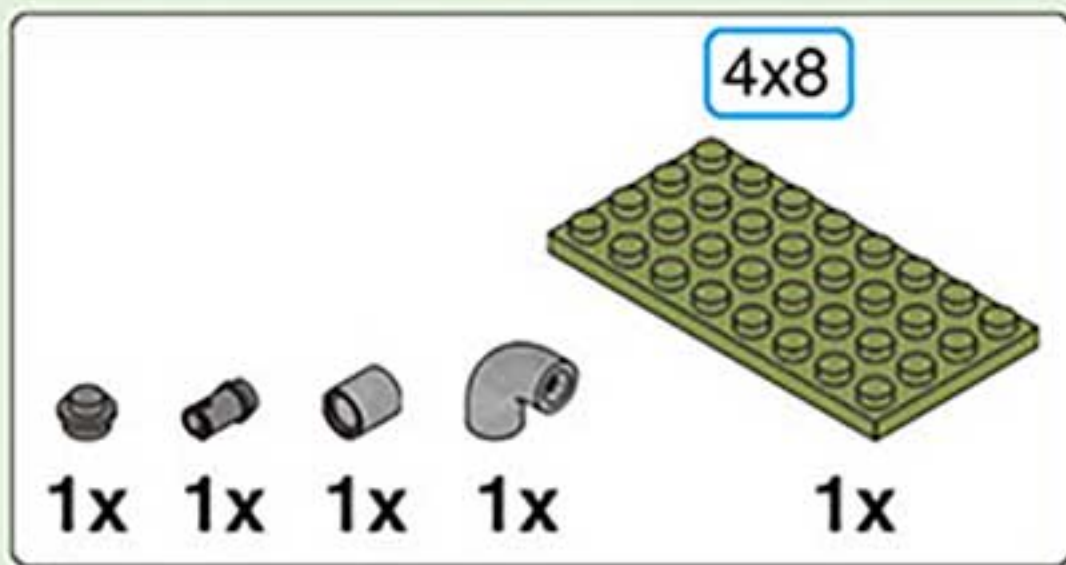

1-13.4

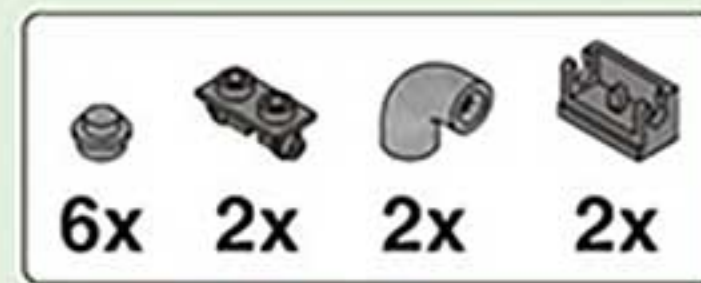
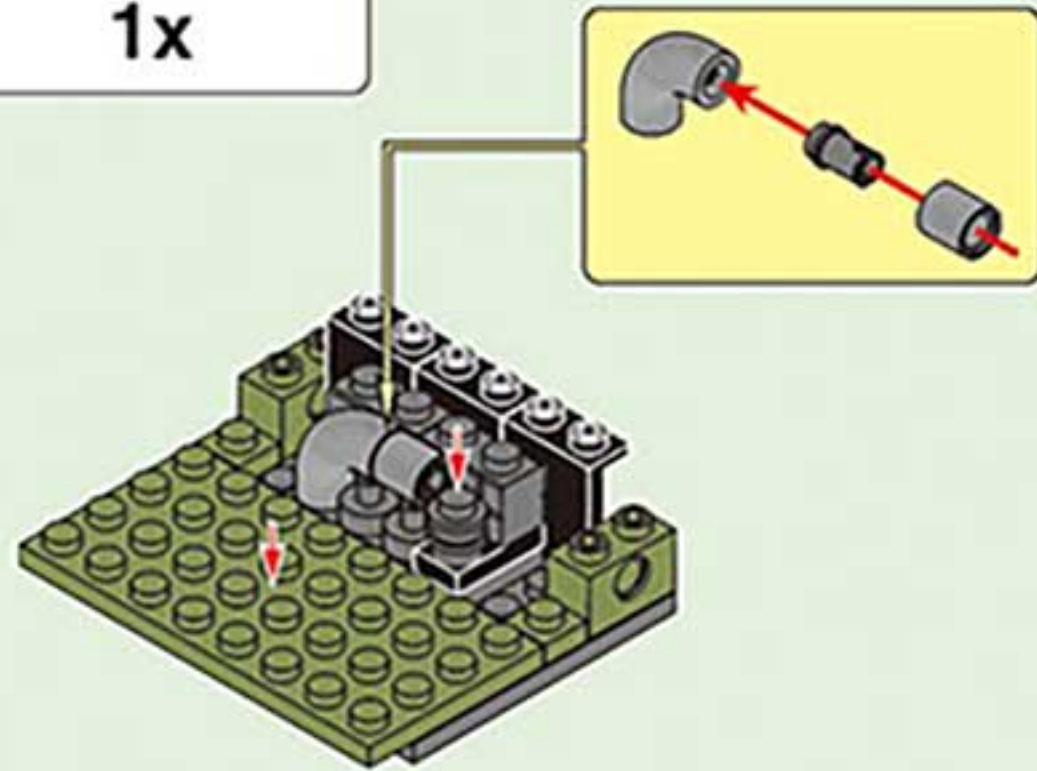

1-13.5

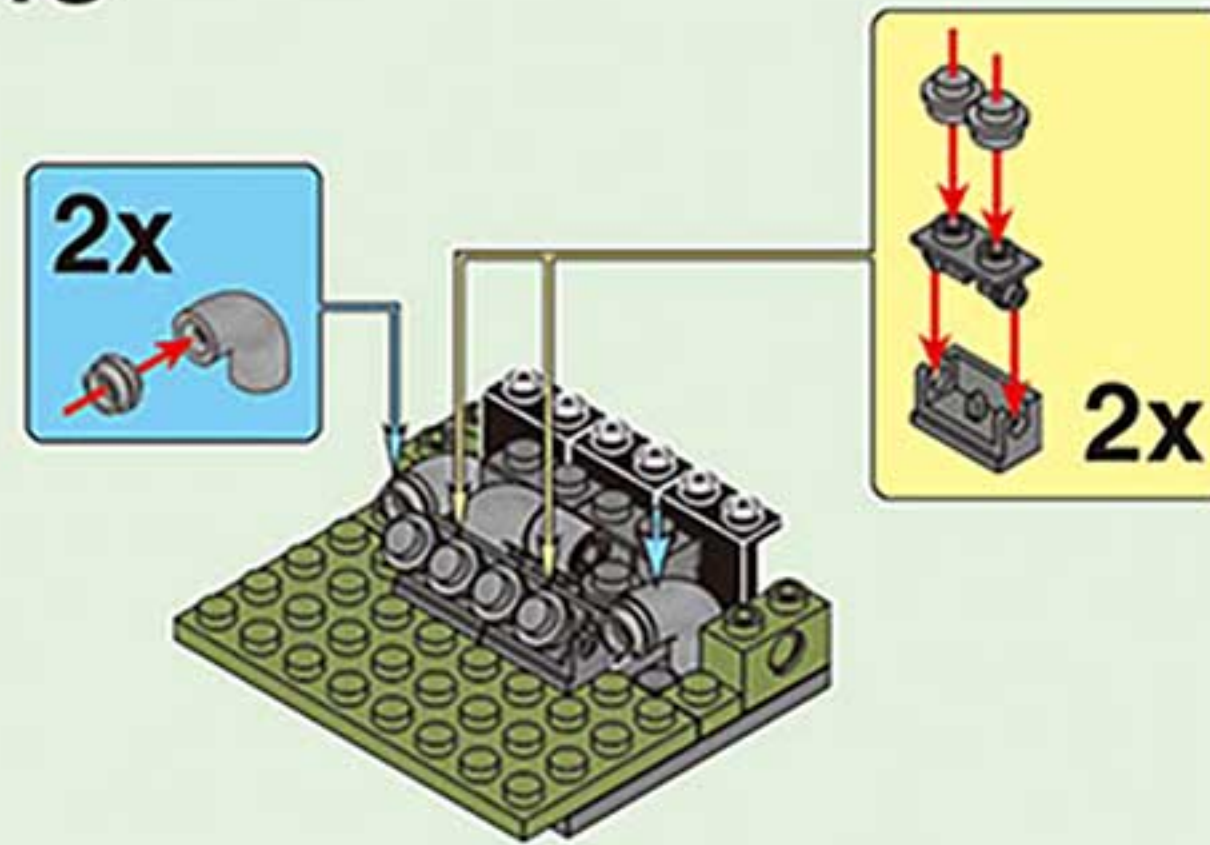

1-13.6

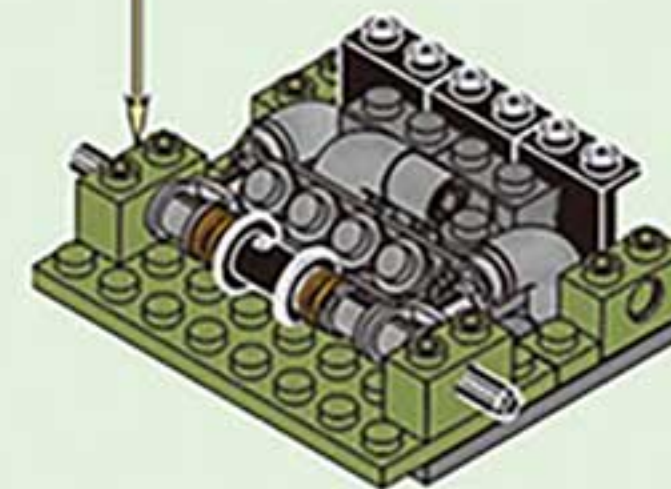
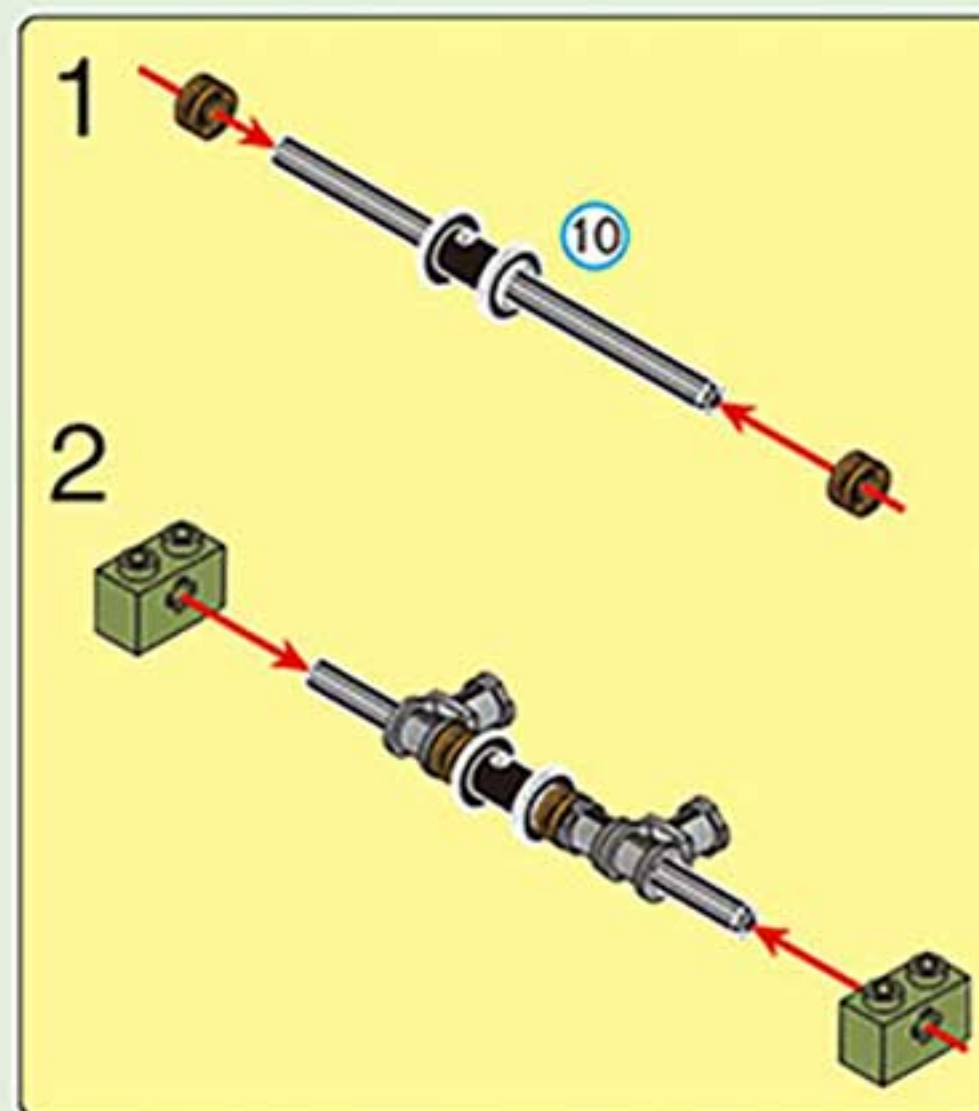

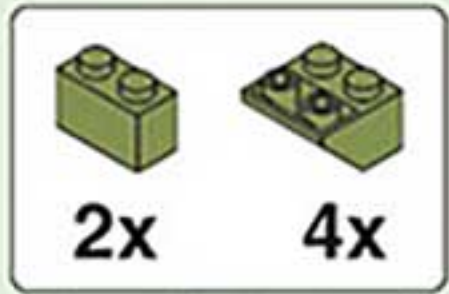

1-13.7

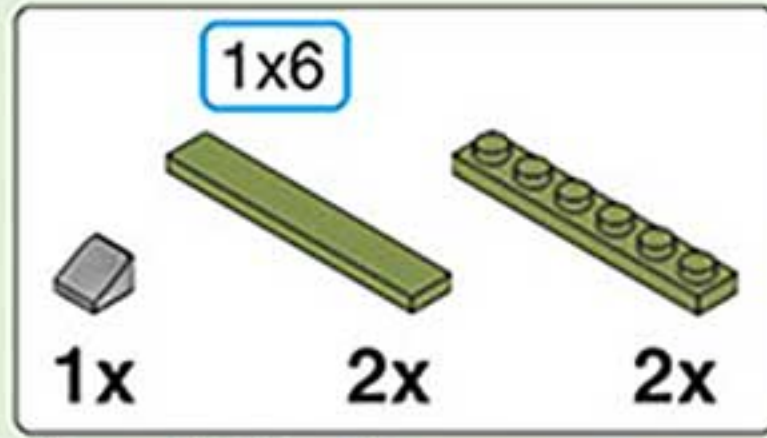
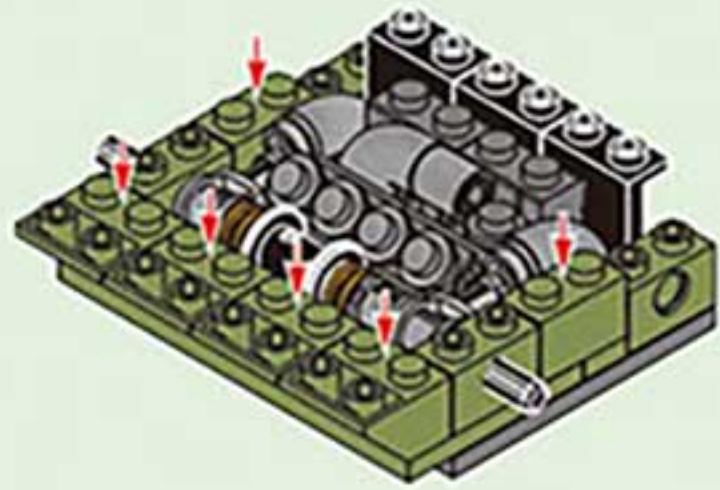

1-13.8

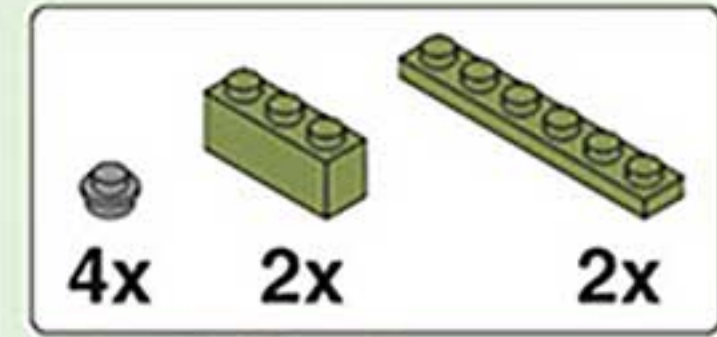
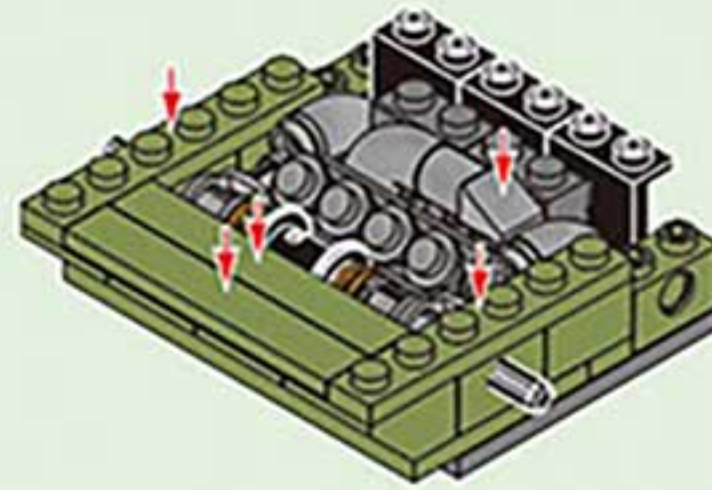

1-13.9

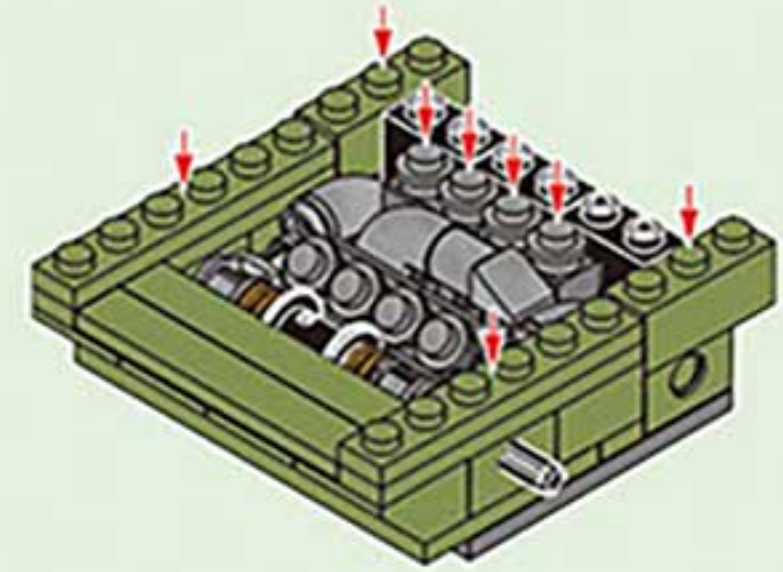

1-14

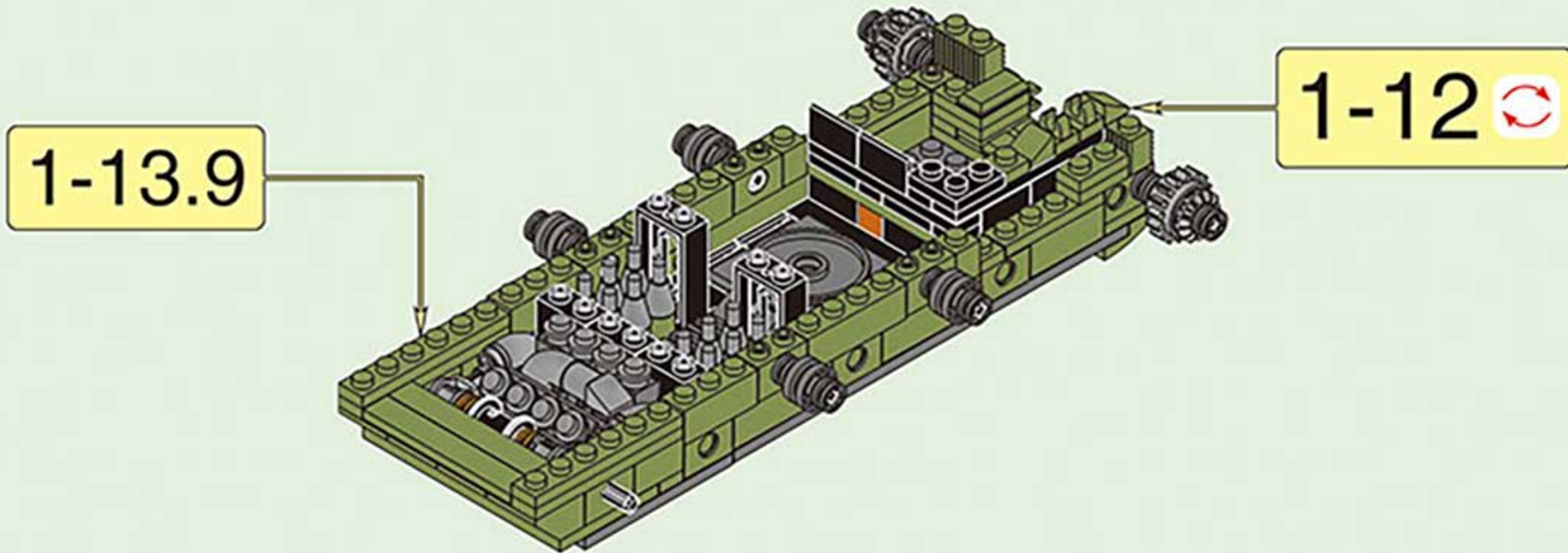

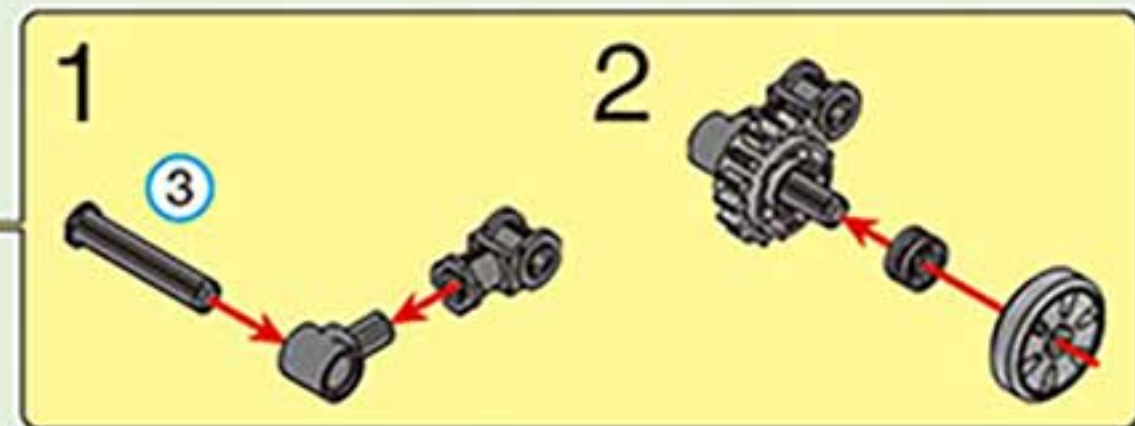
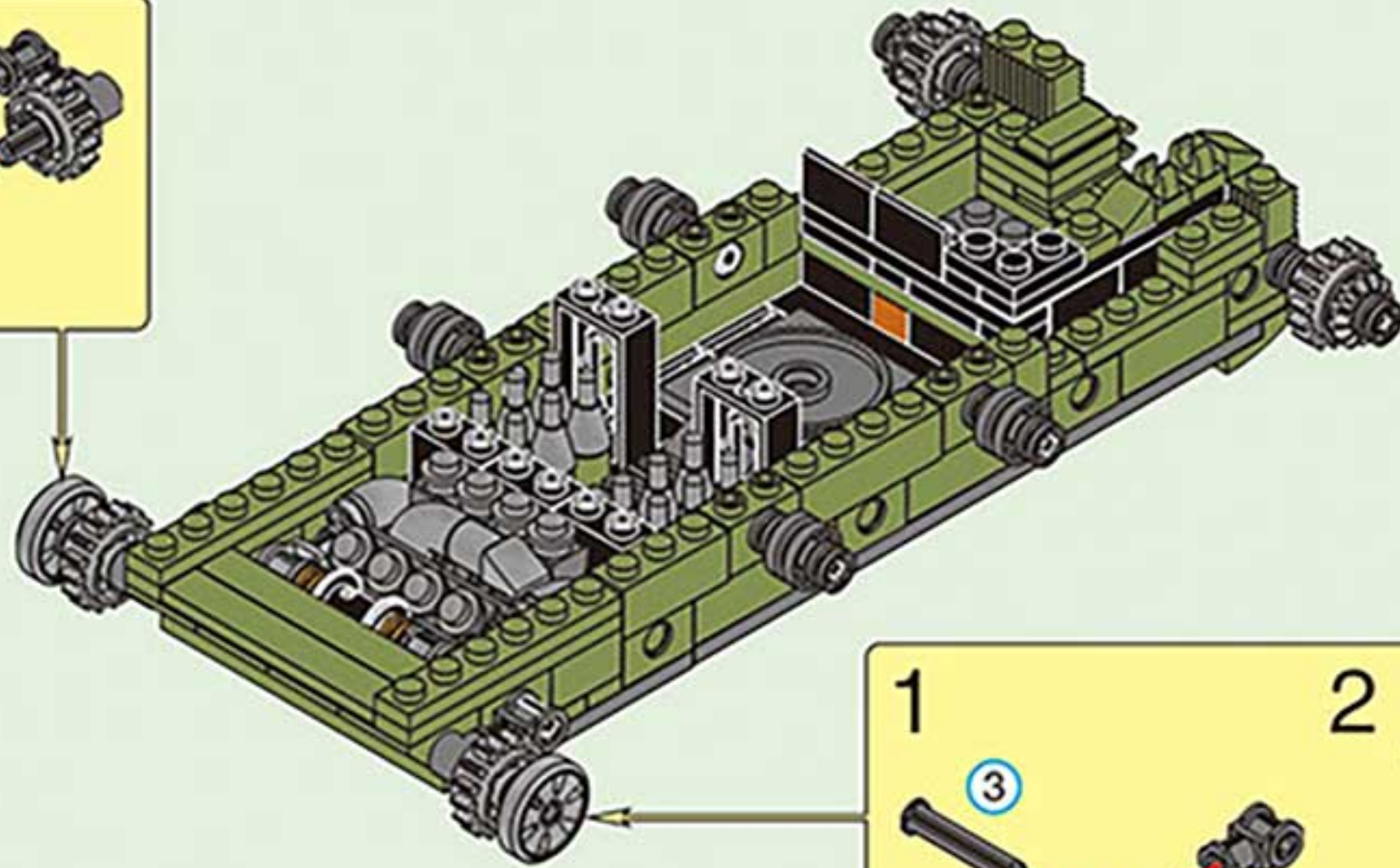
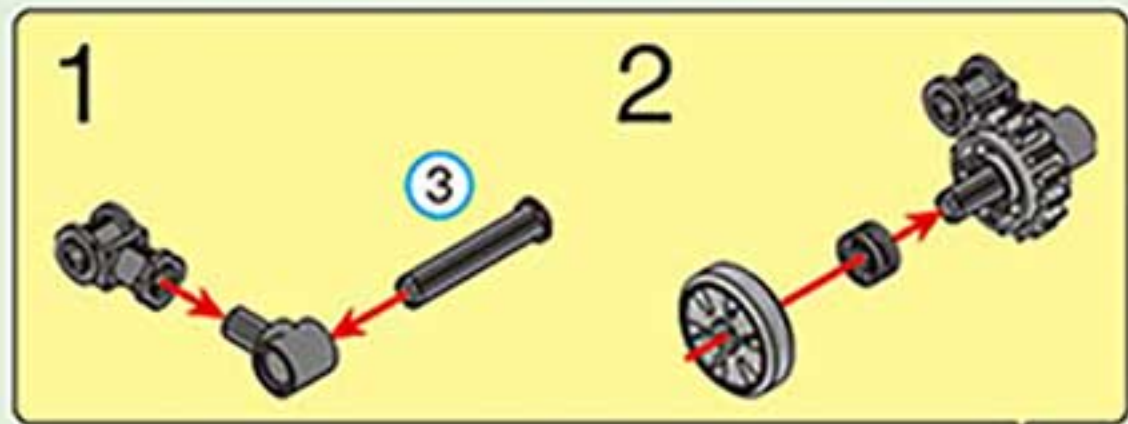

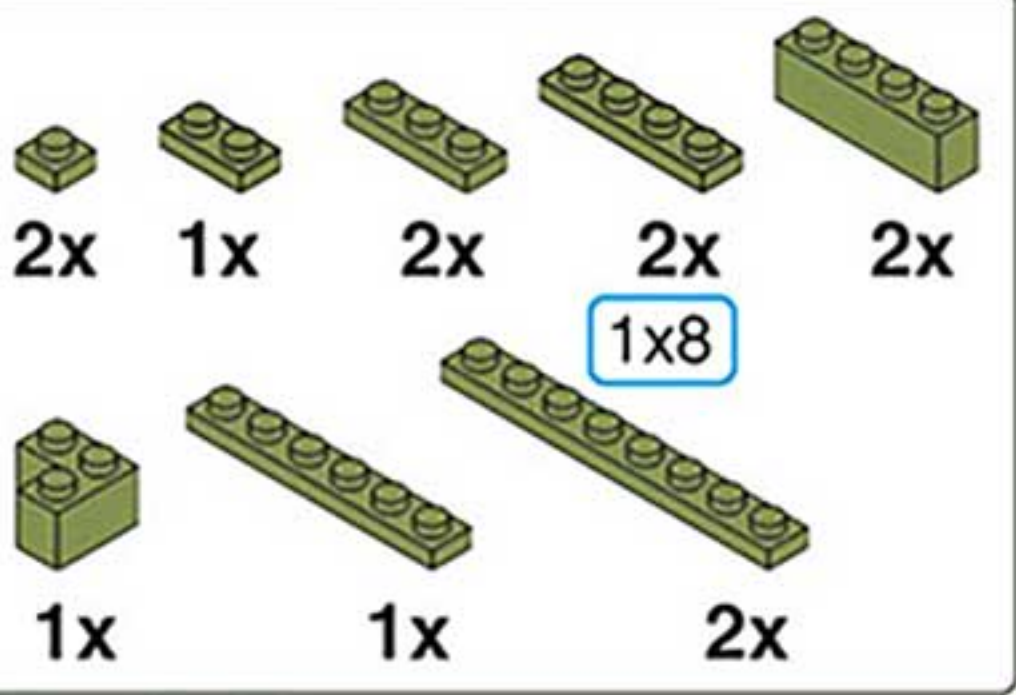

1-16

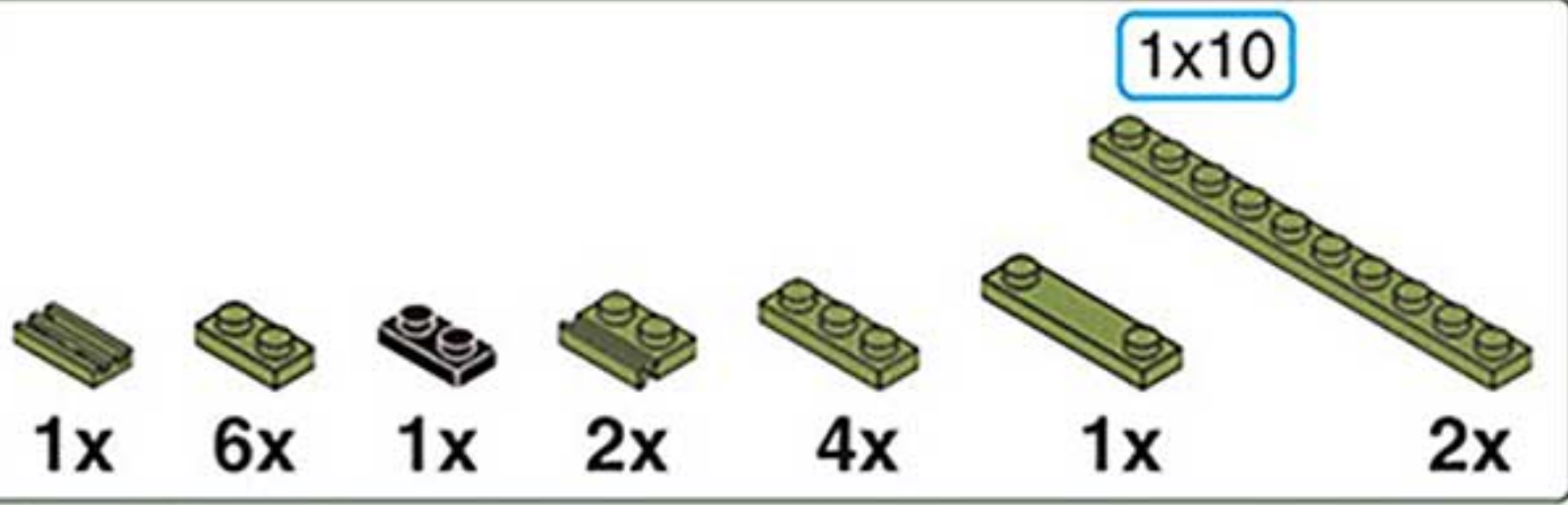
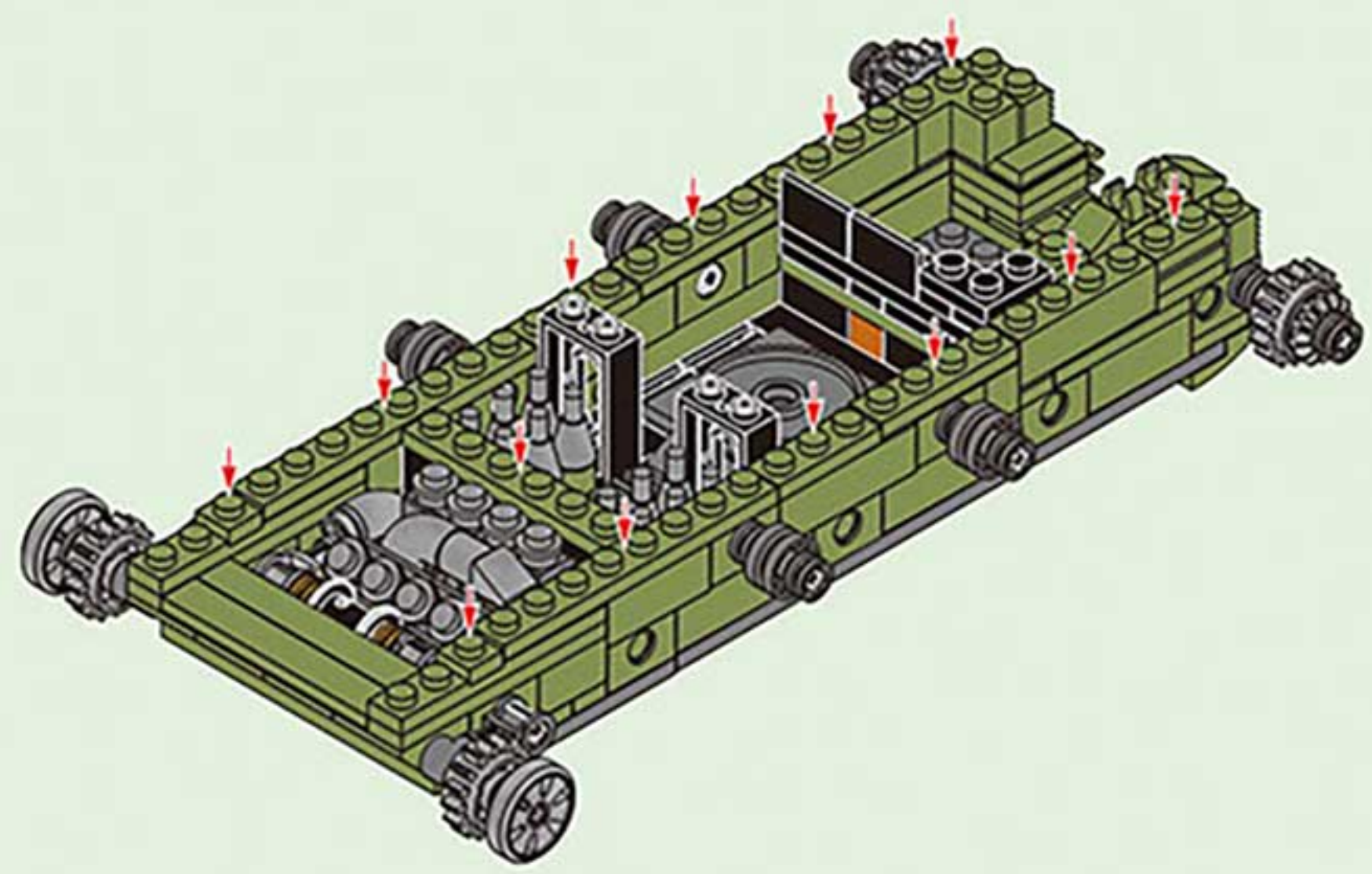

1-17

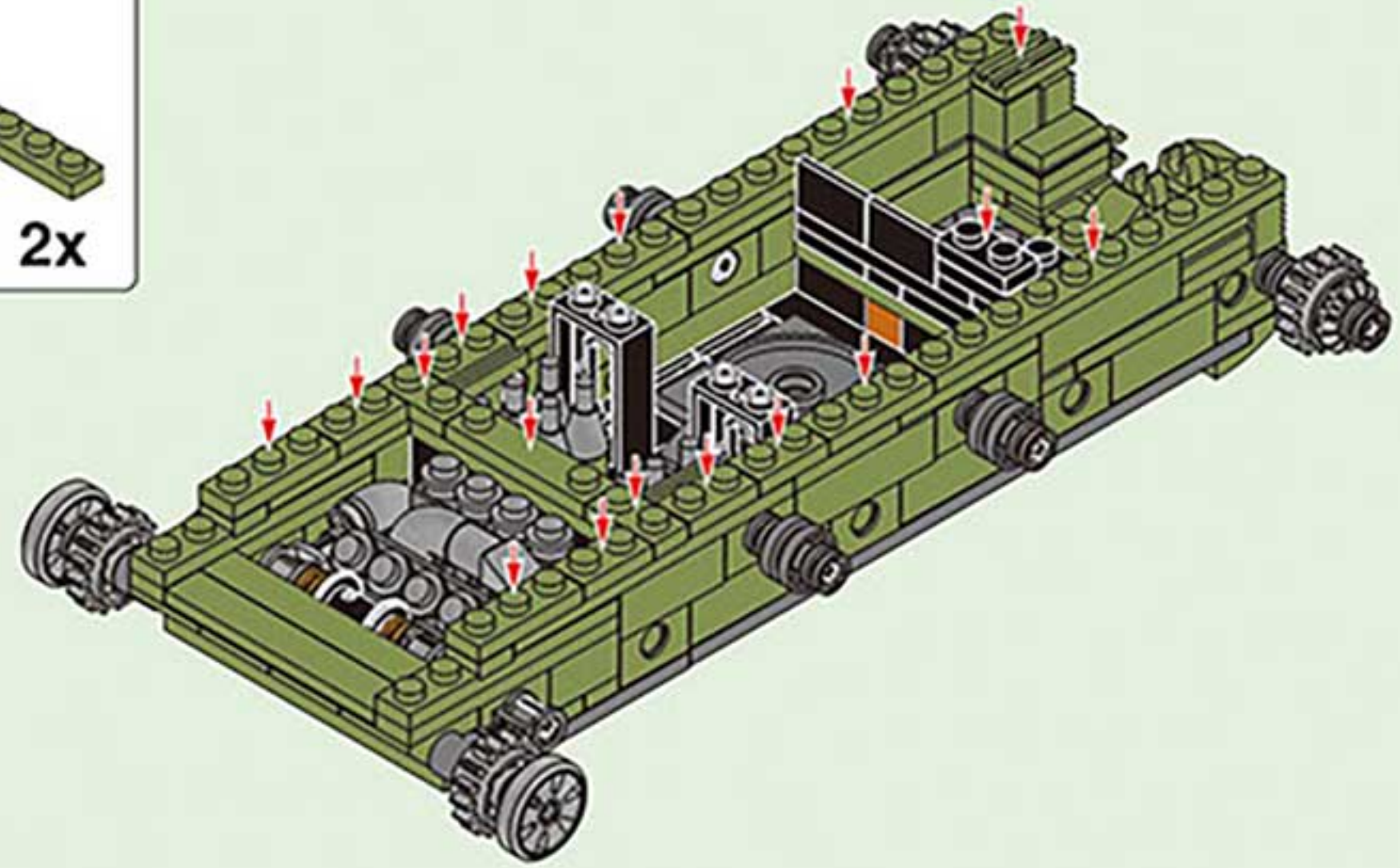



# 1-18

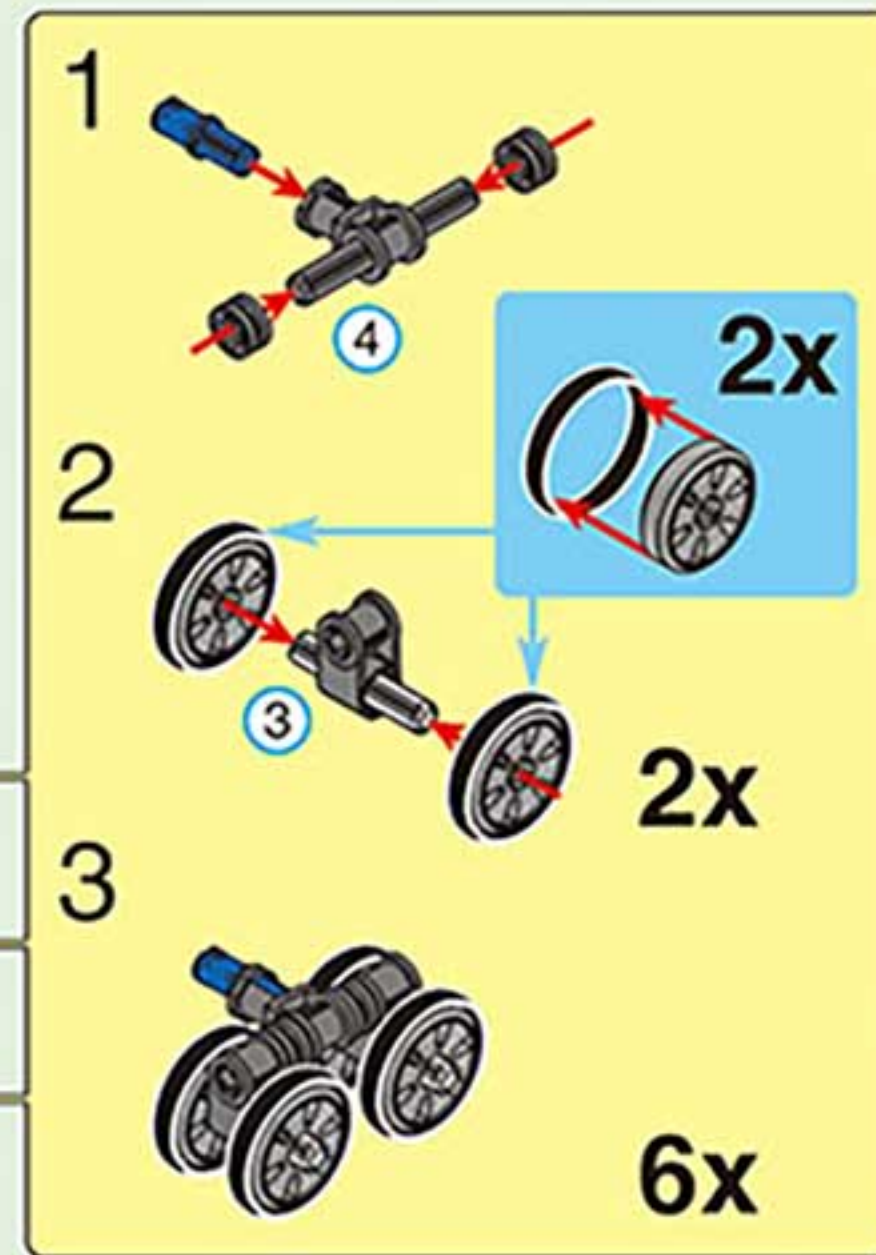
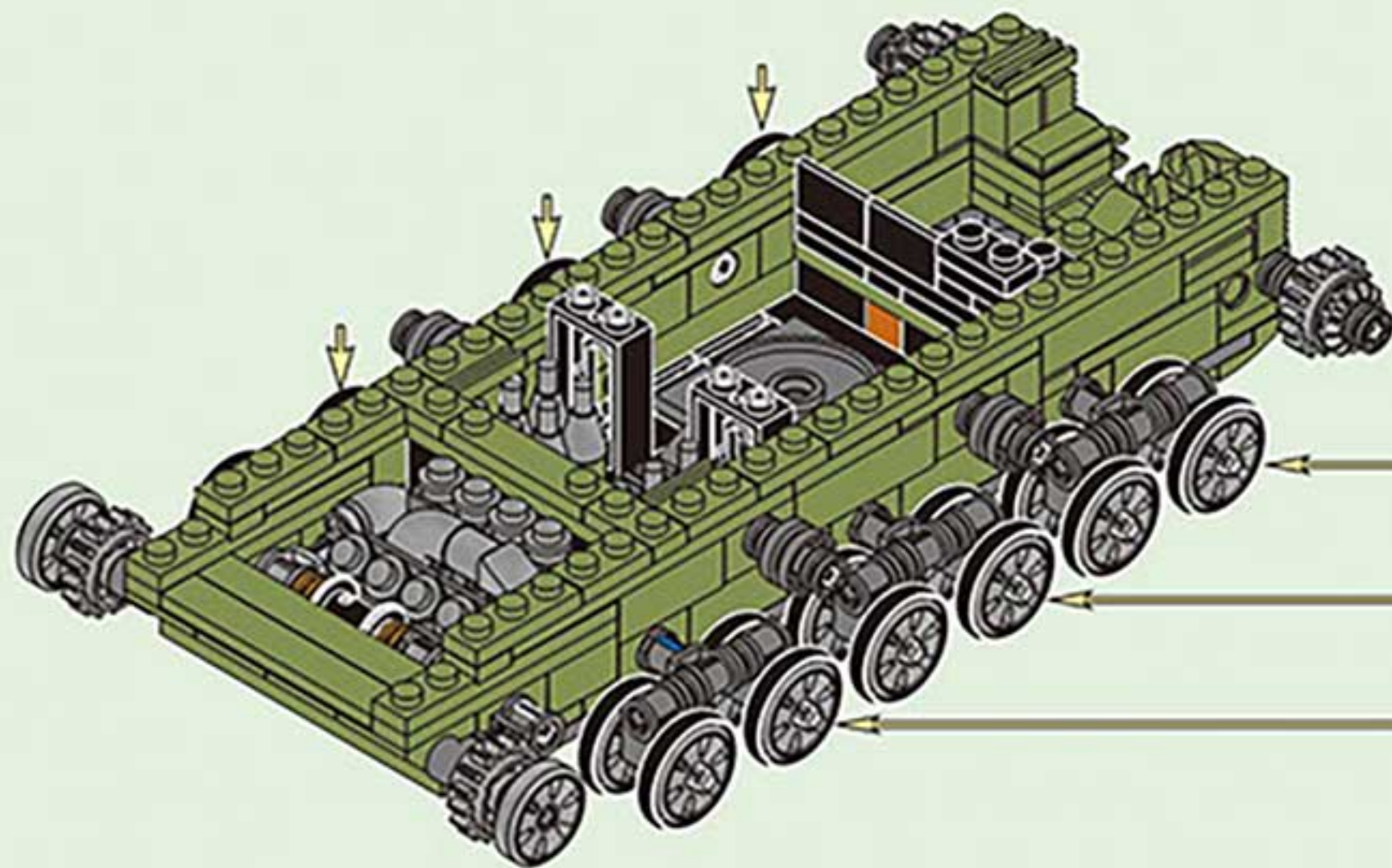



2



x4

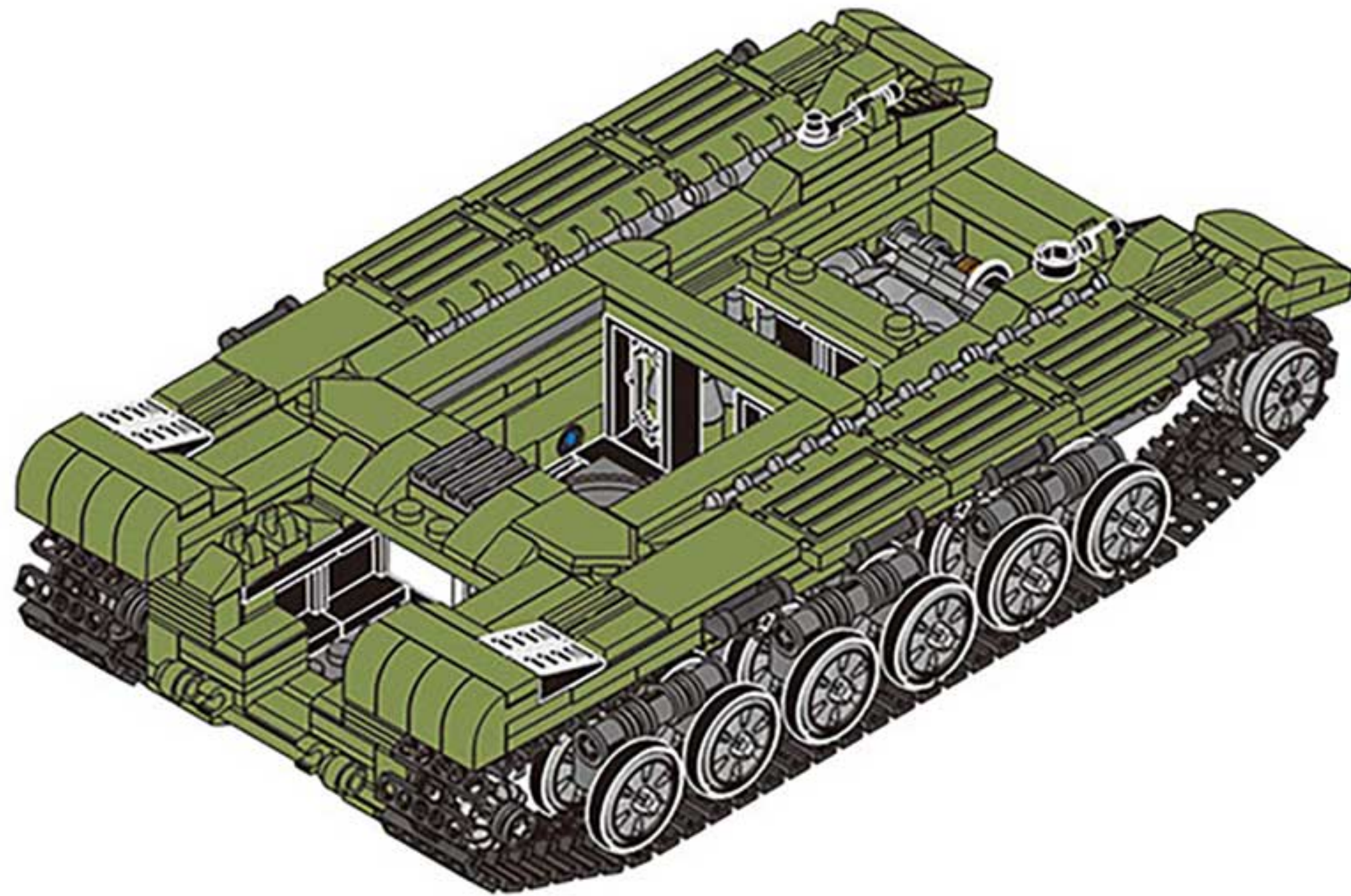



130x

2-1

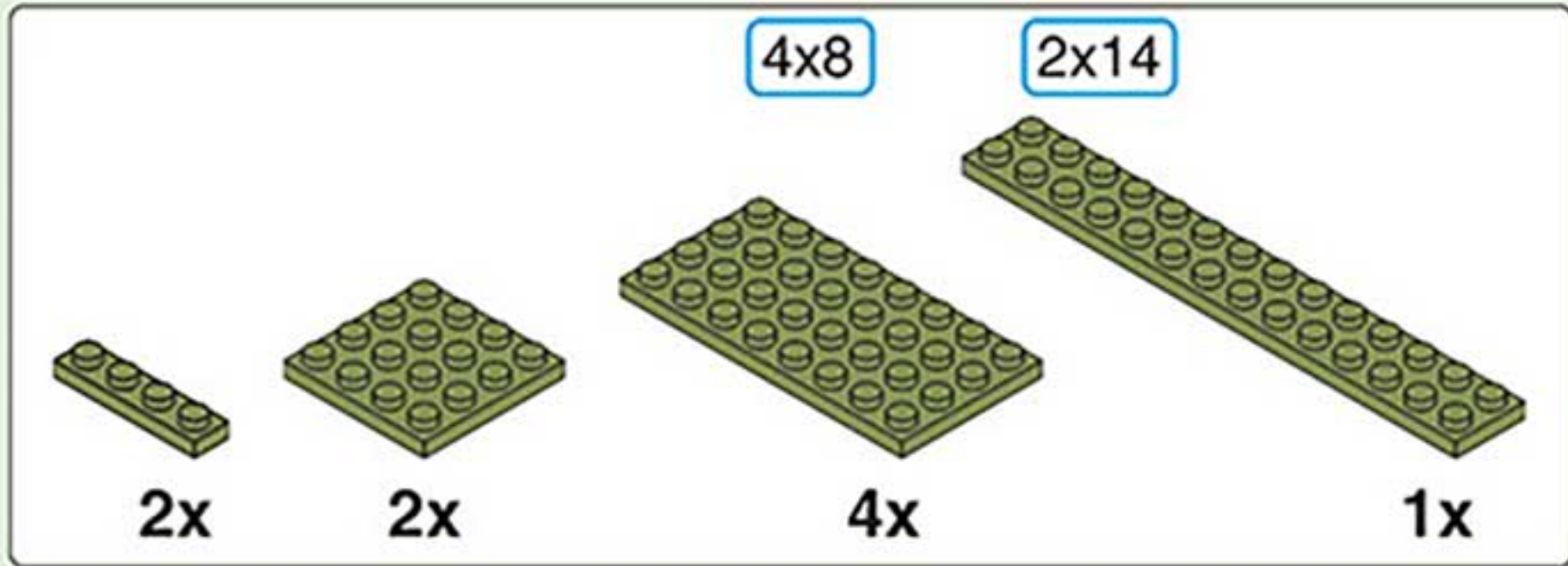
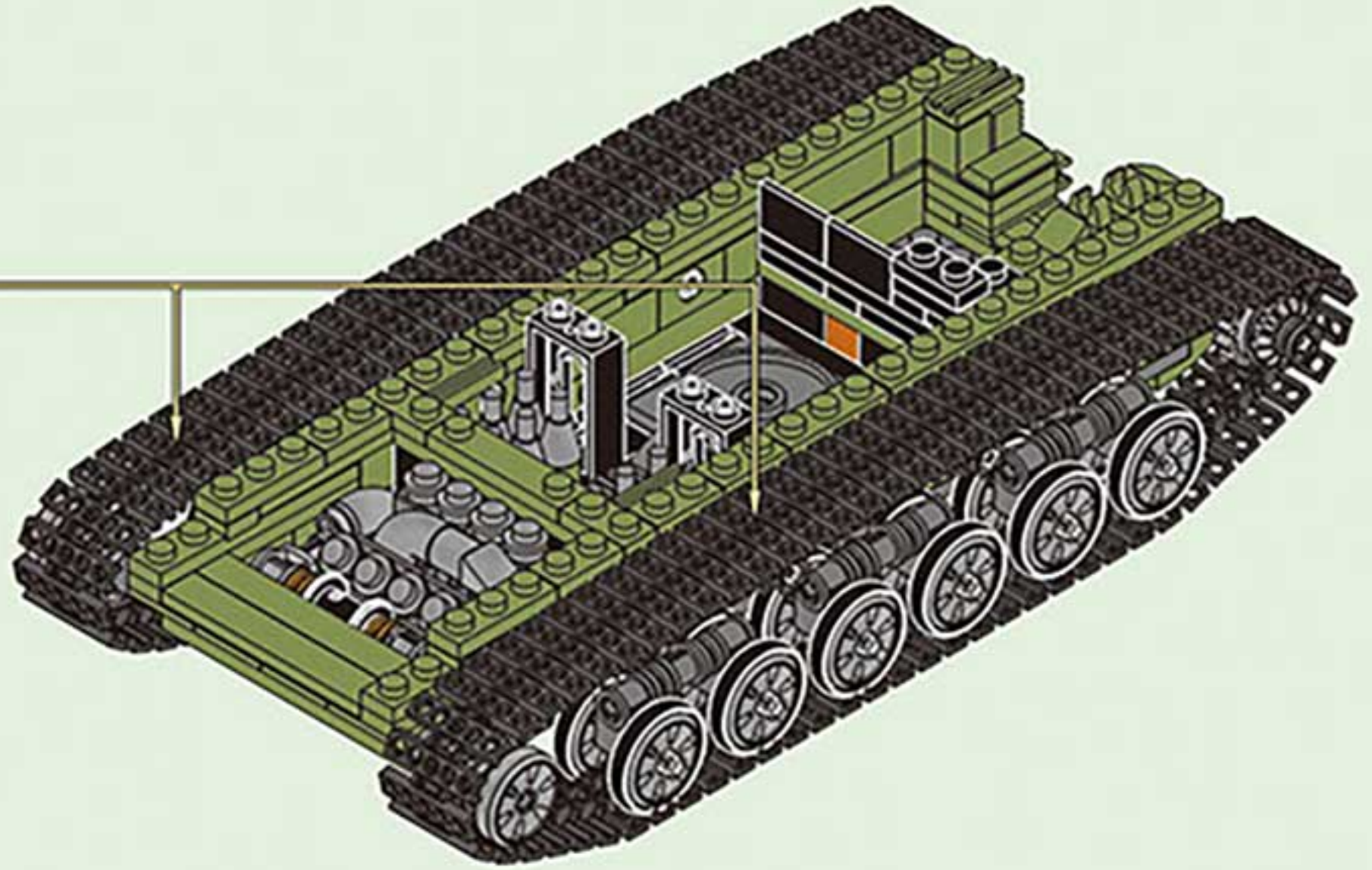
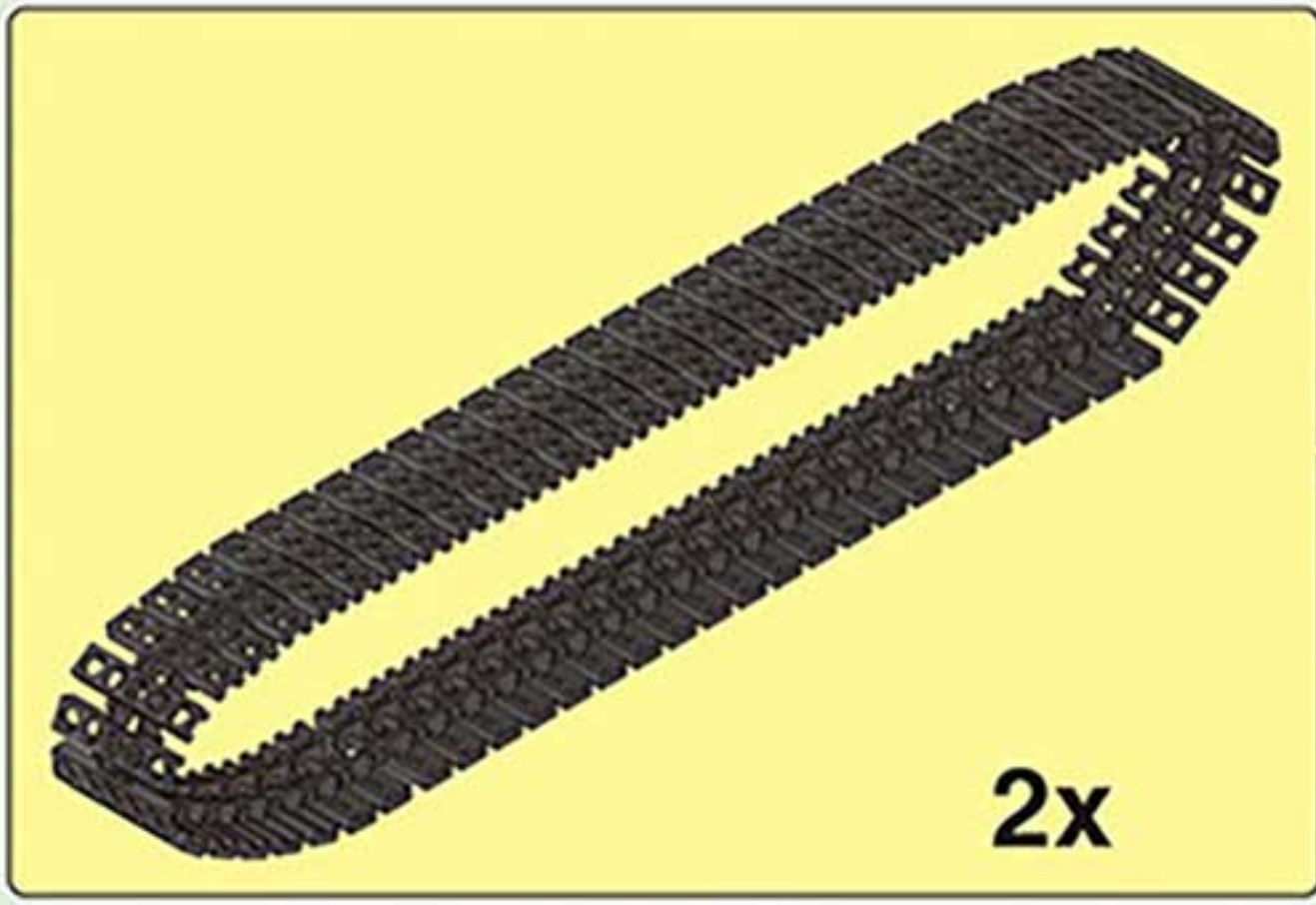

2-2

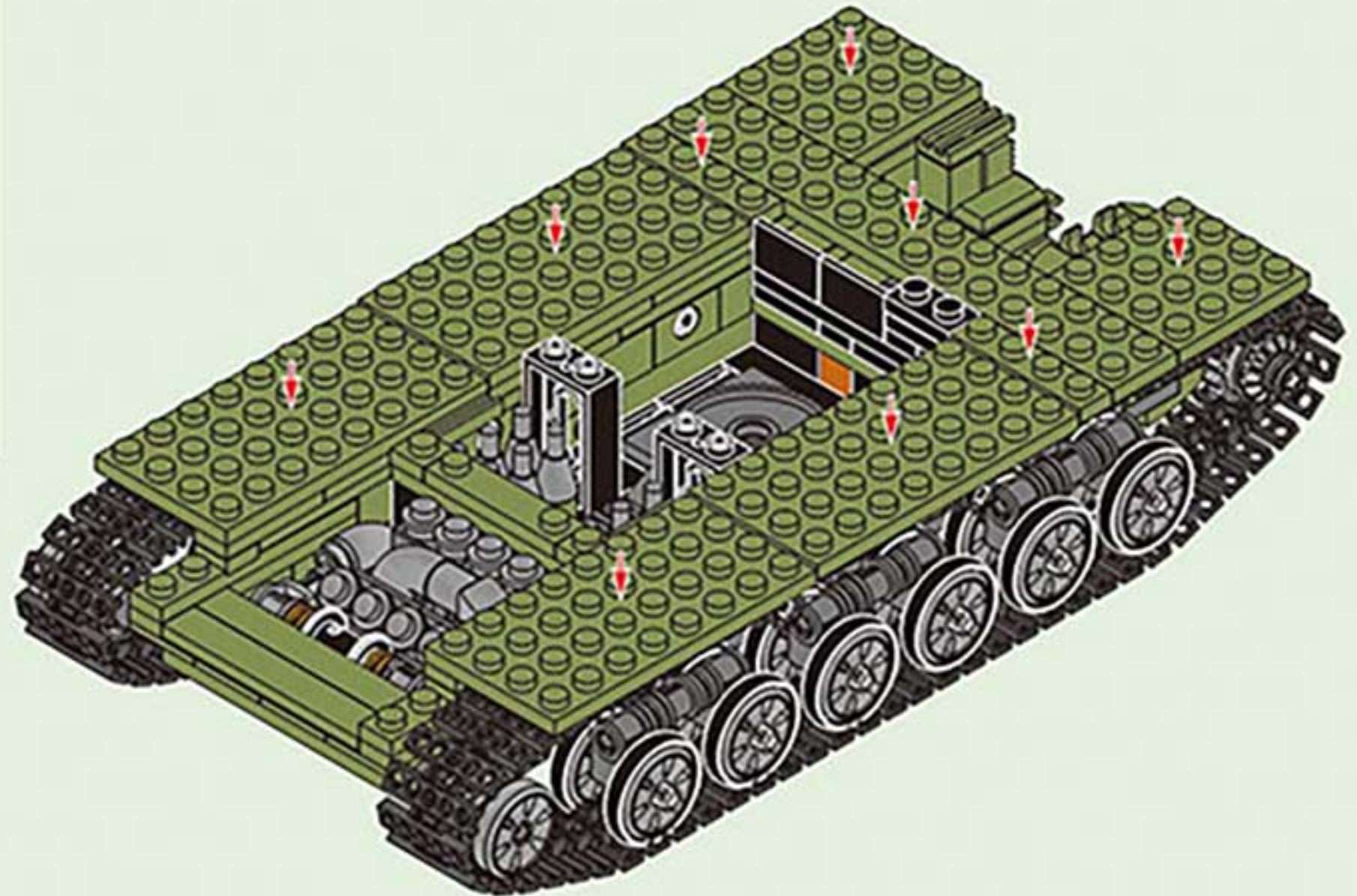

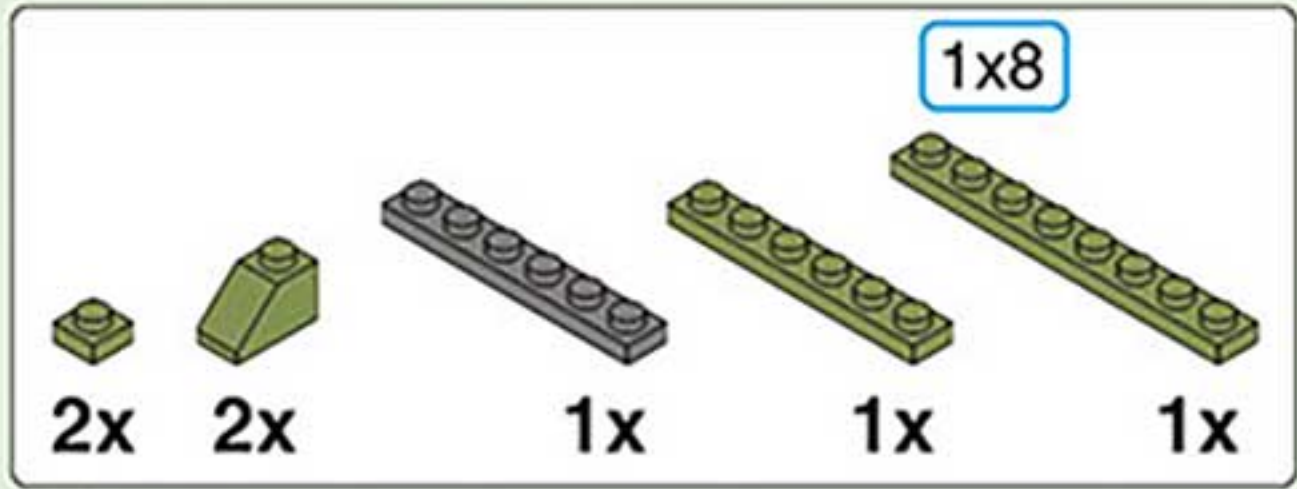

2-3

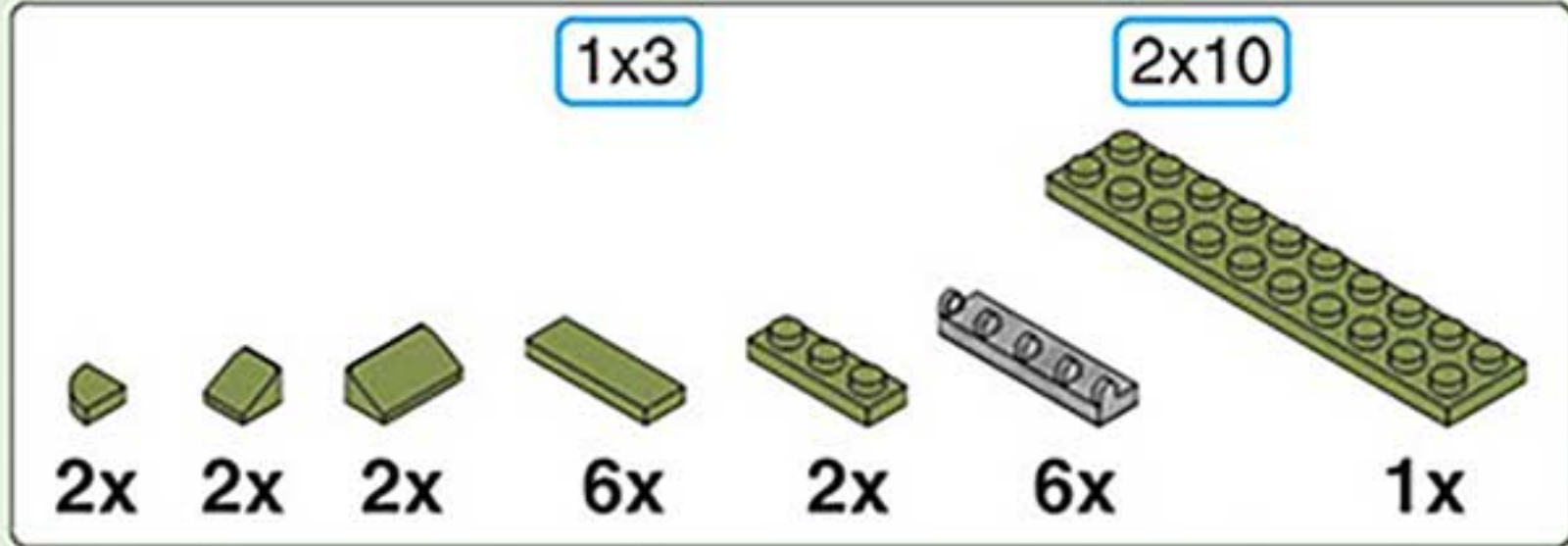
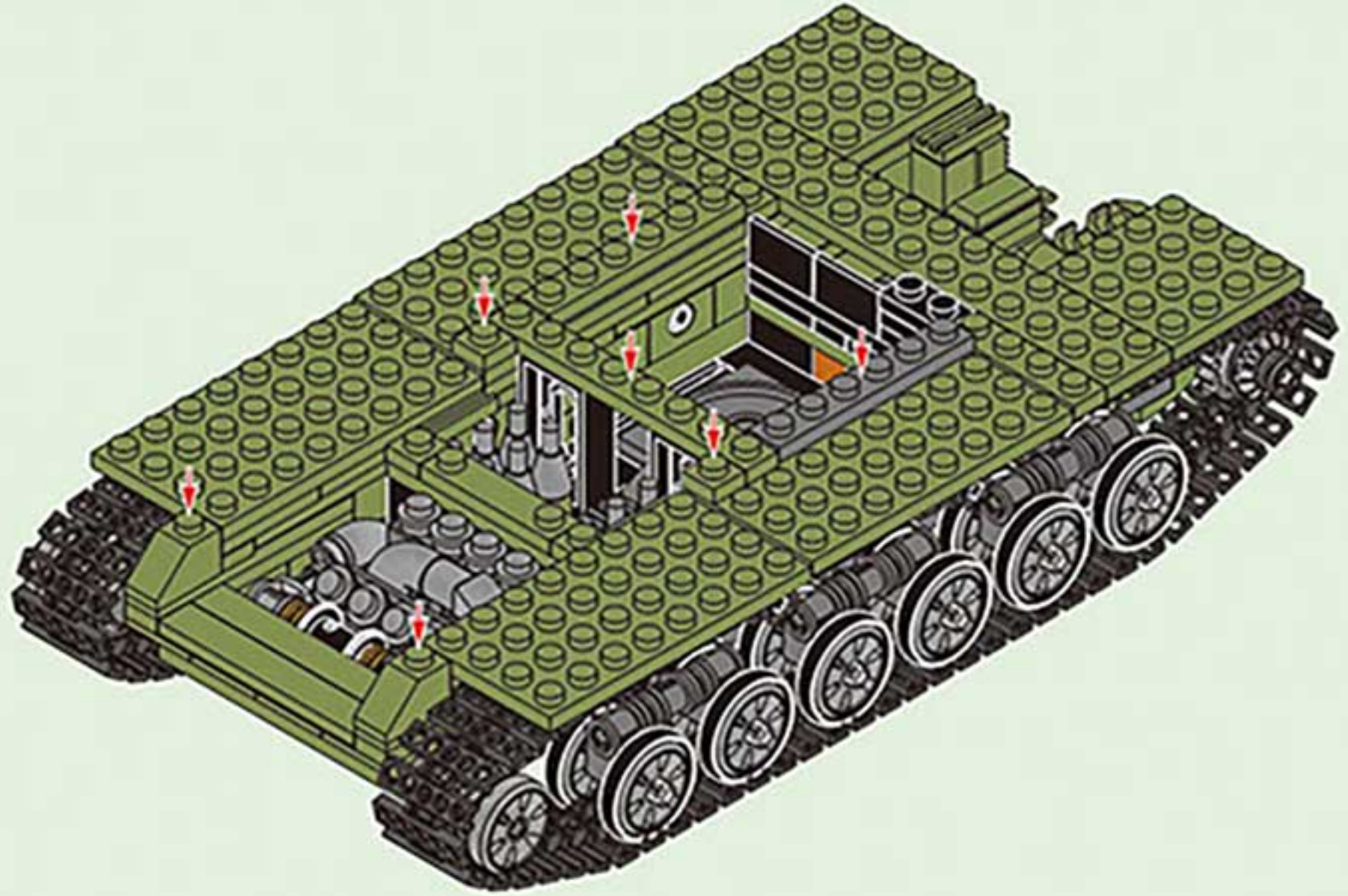

2-4

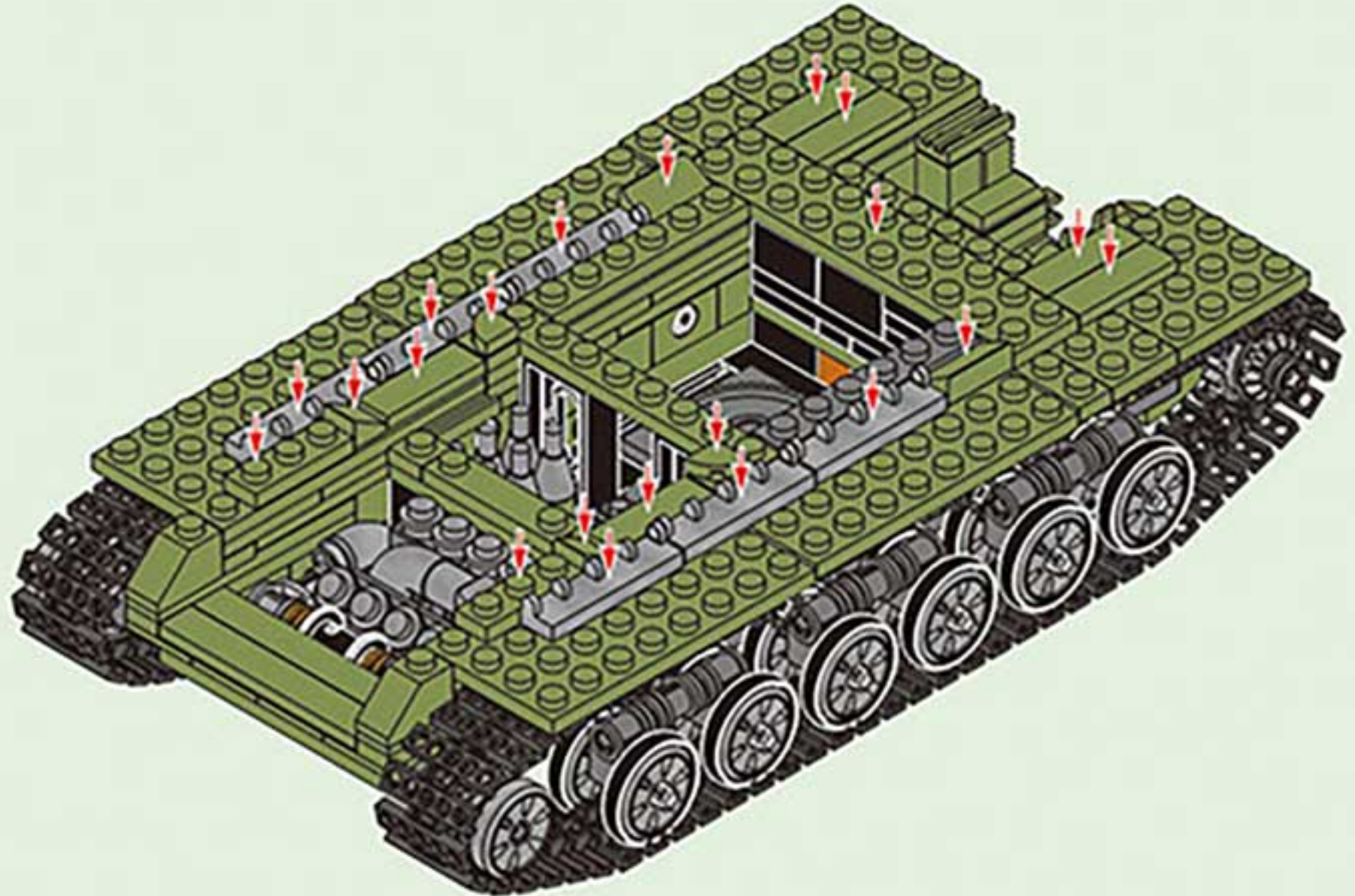

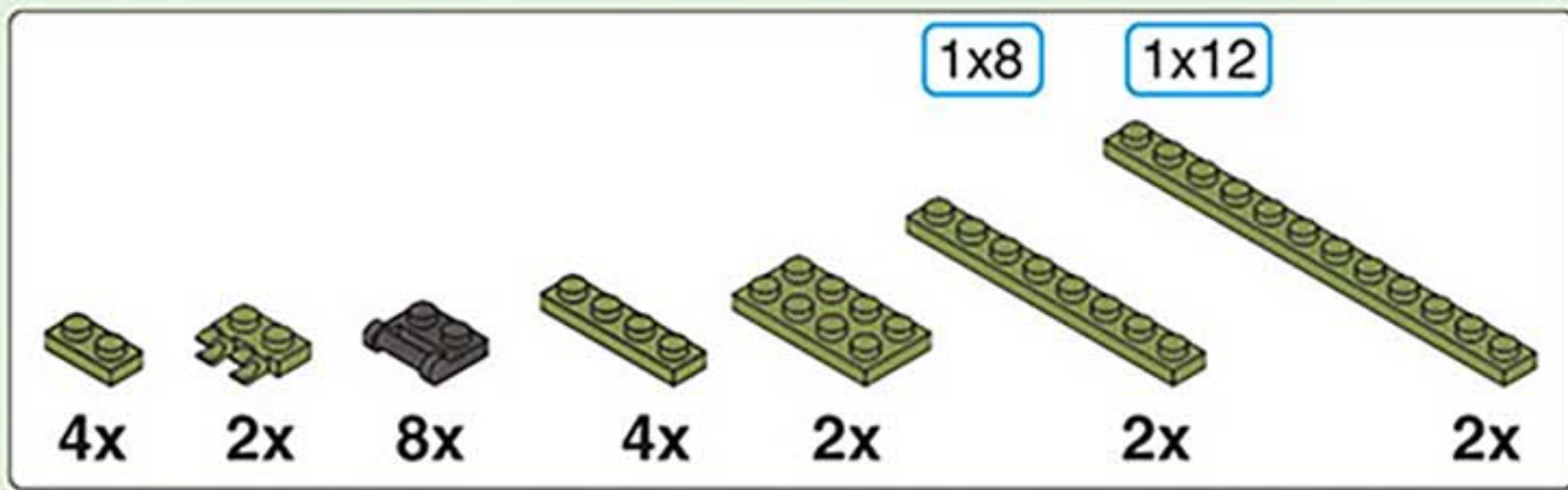

2-5

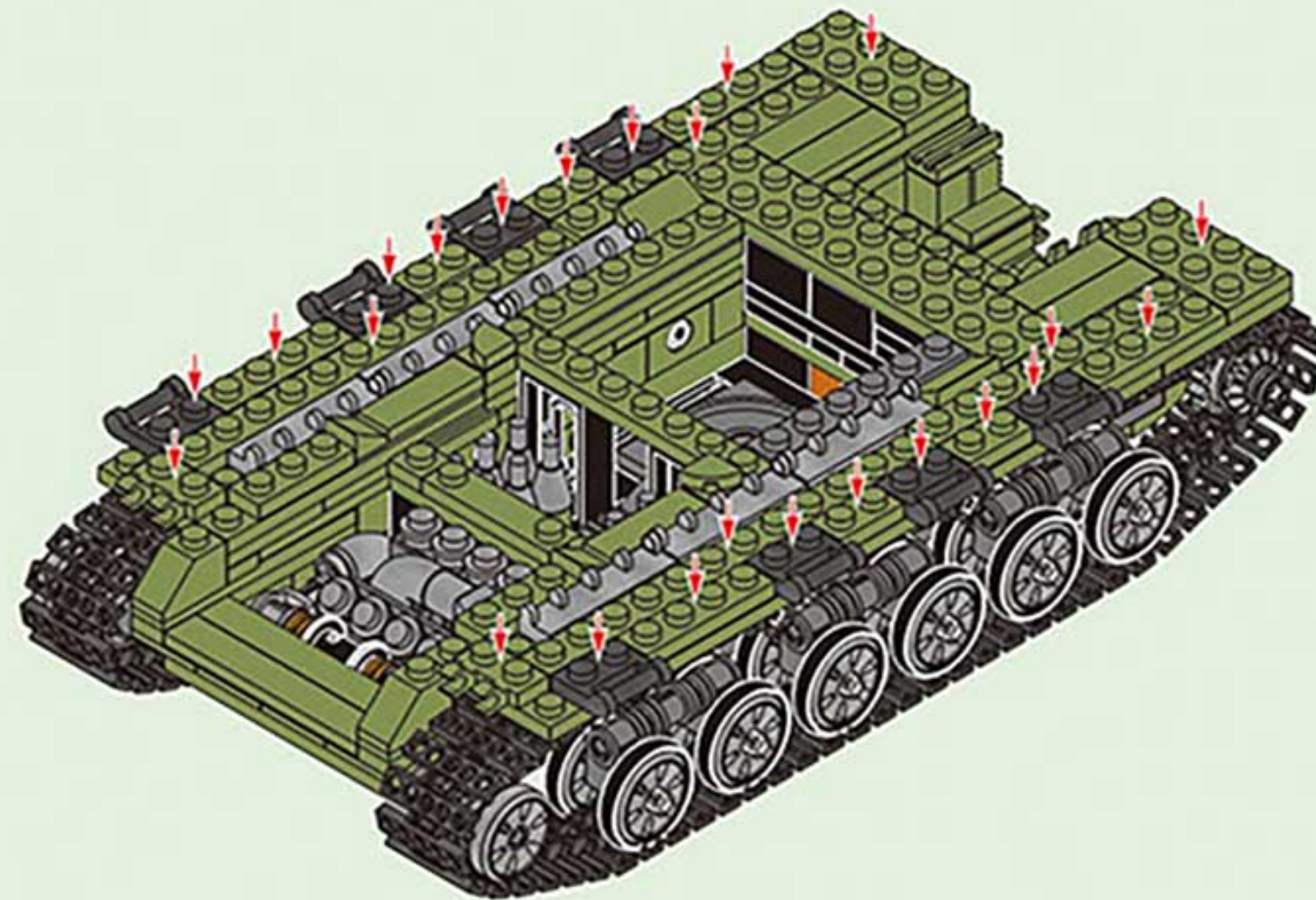

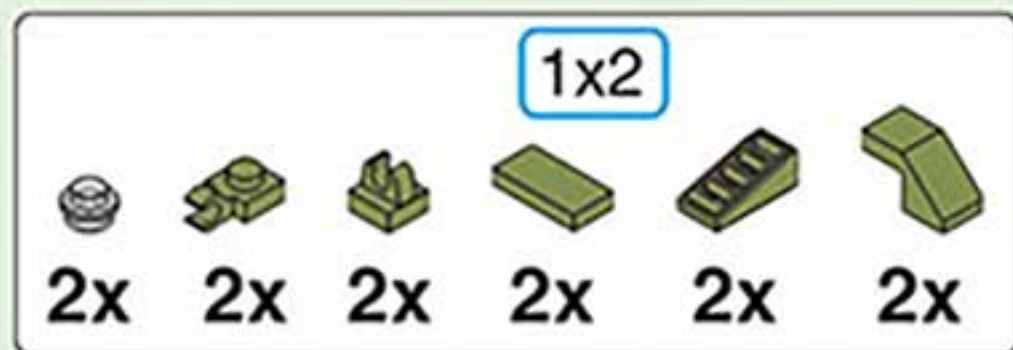

2-6

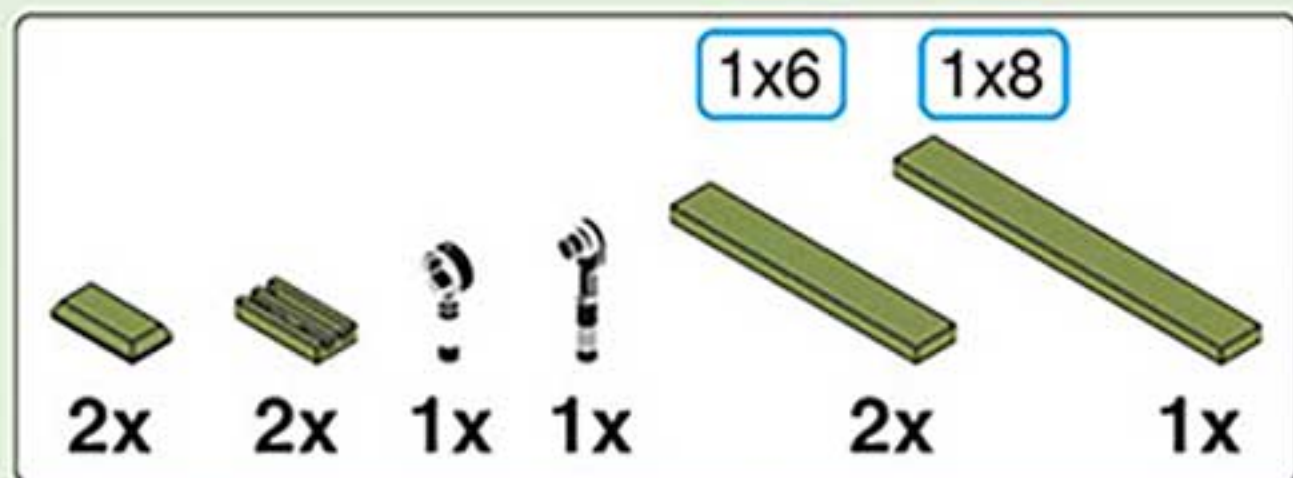
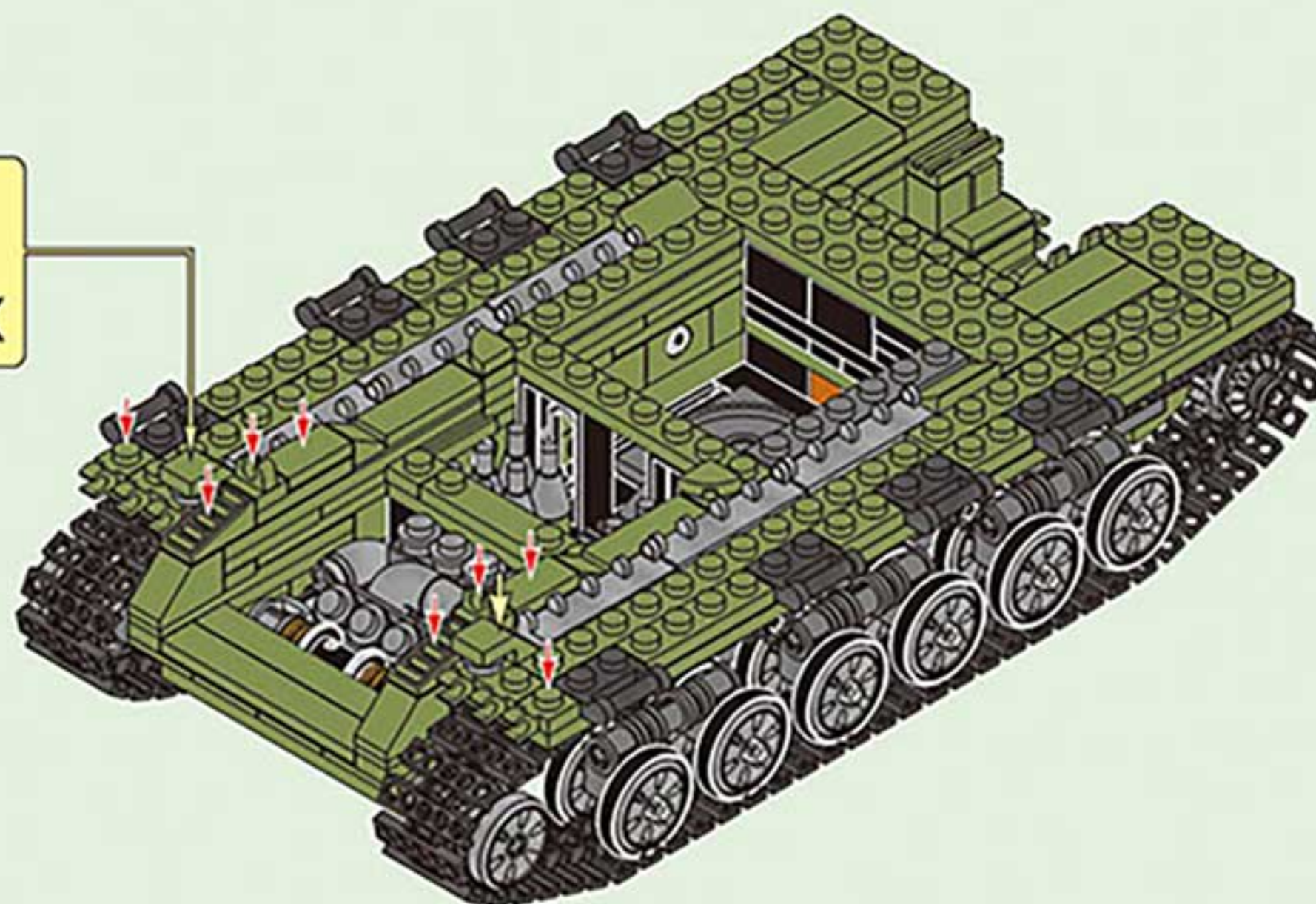
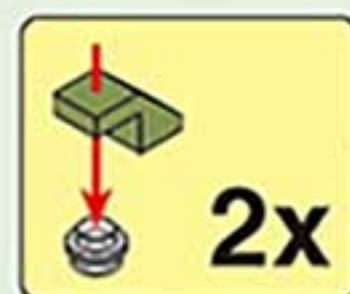

2-7

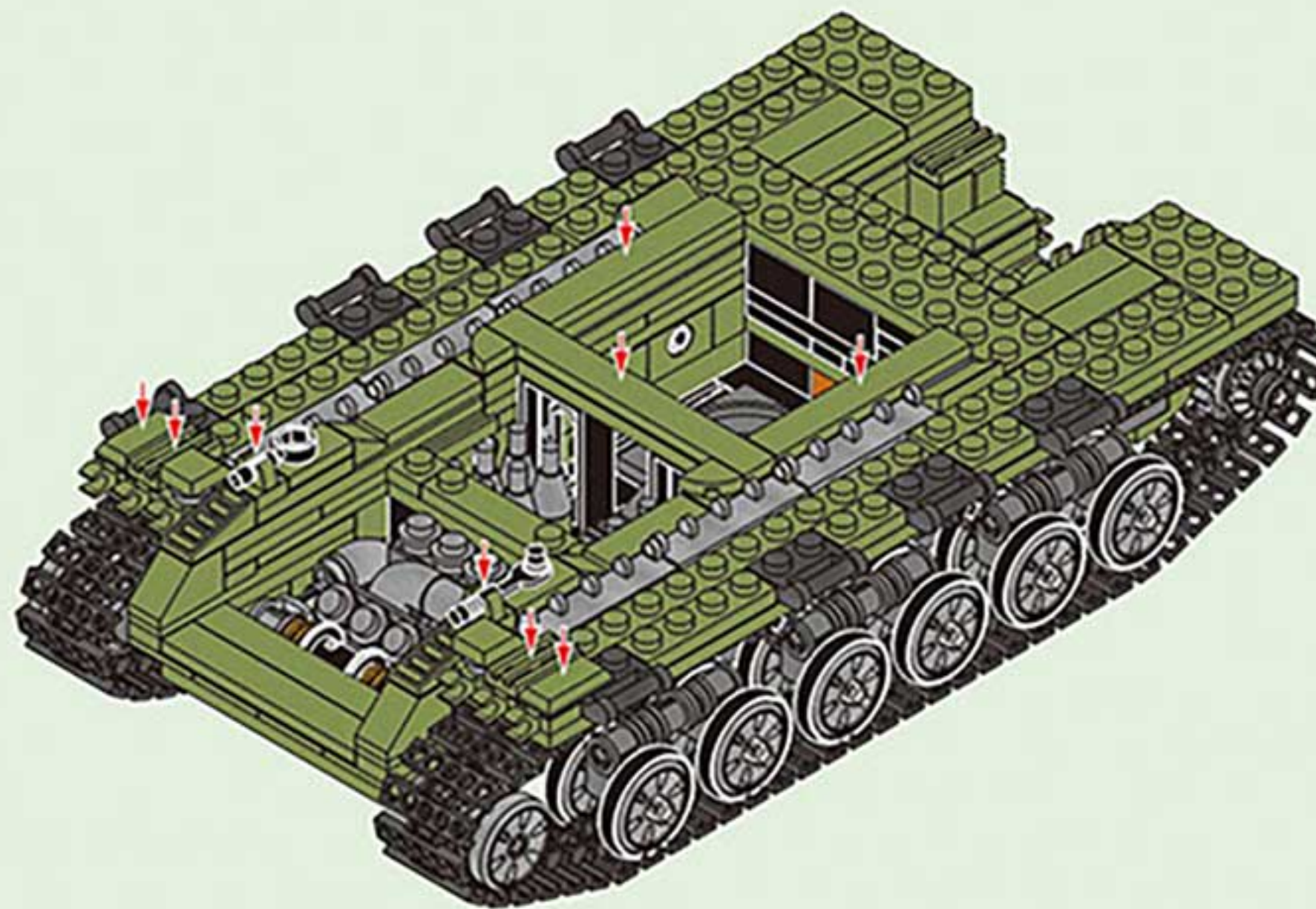



2x



2x



2x



2x

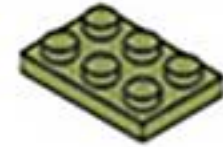

2x

# 2-8

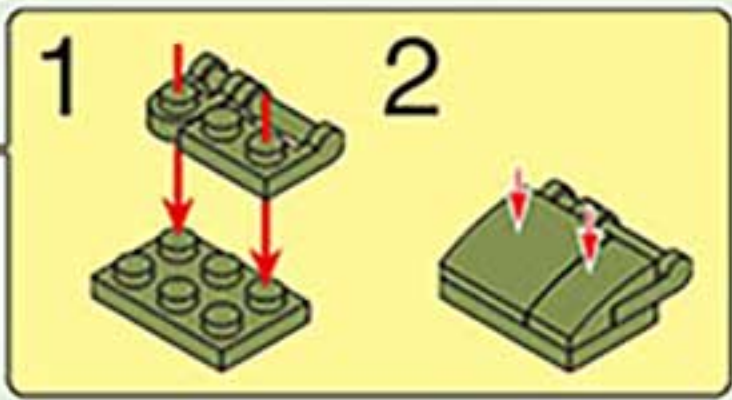
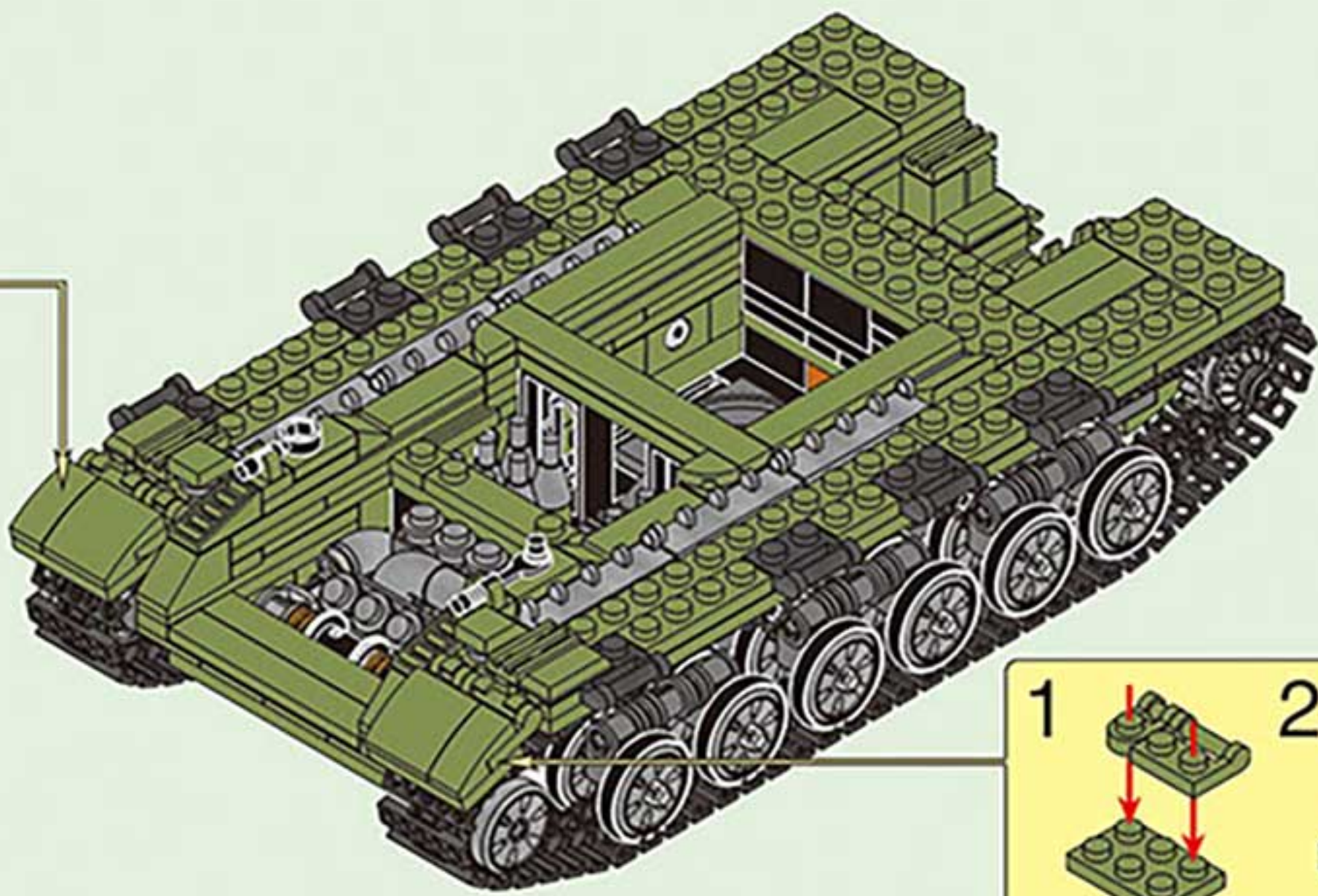
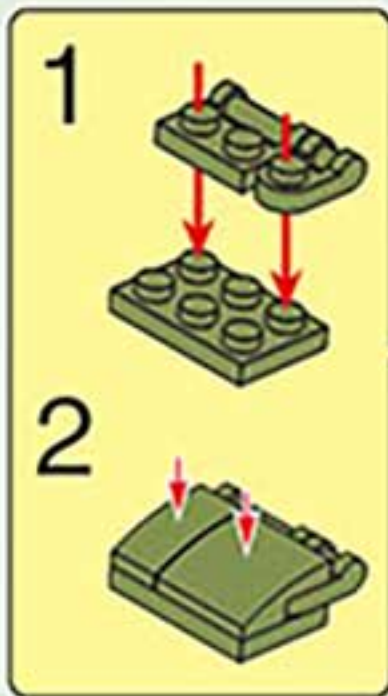

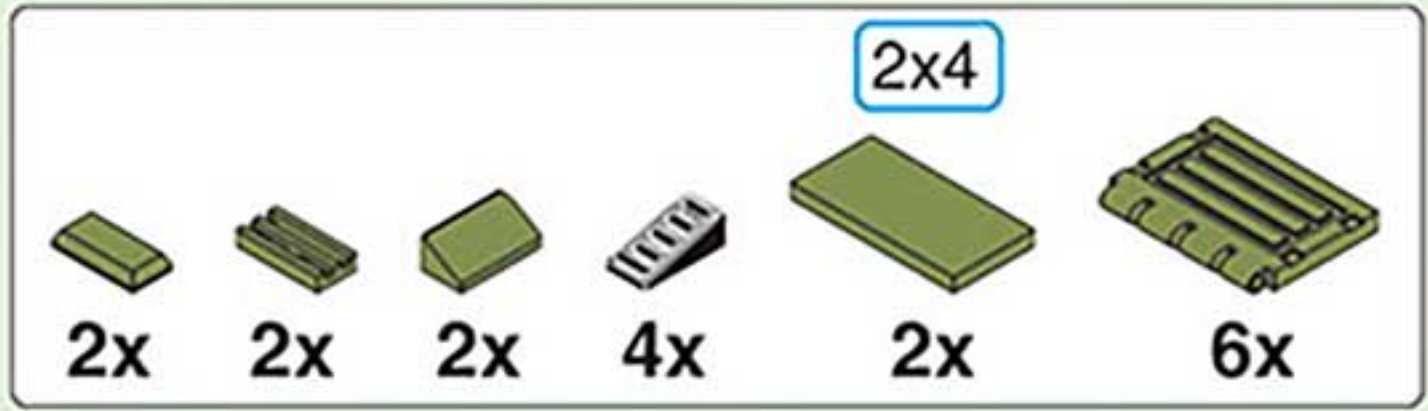

2-9

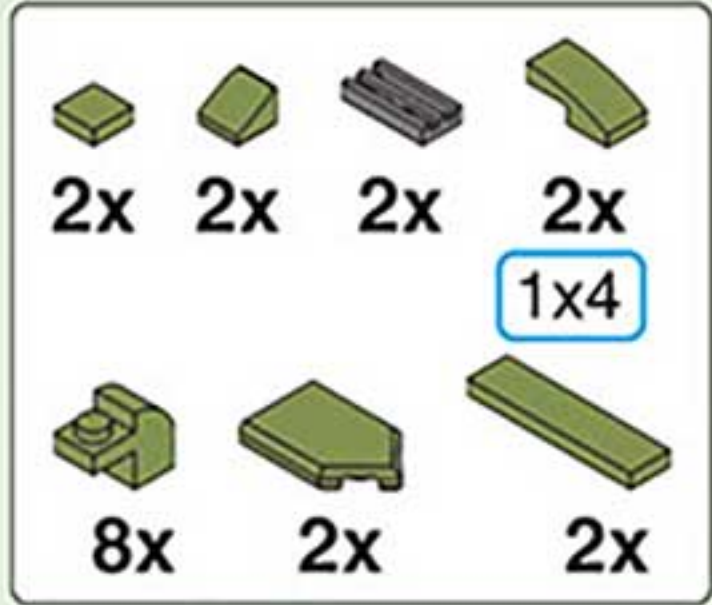
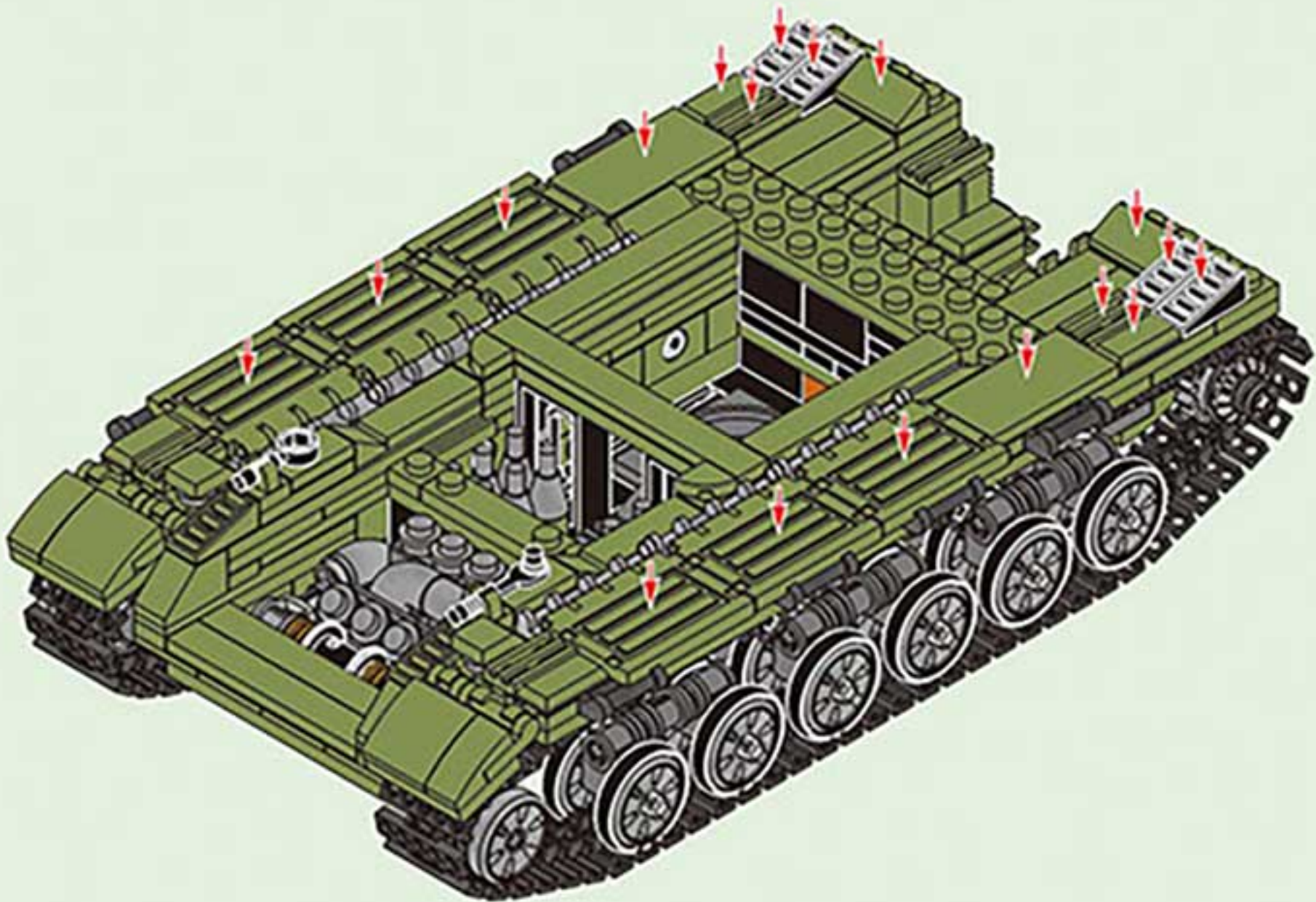

2-10

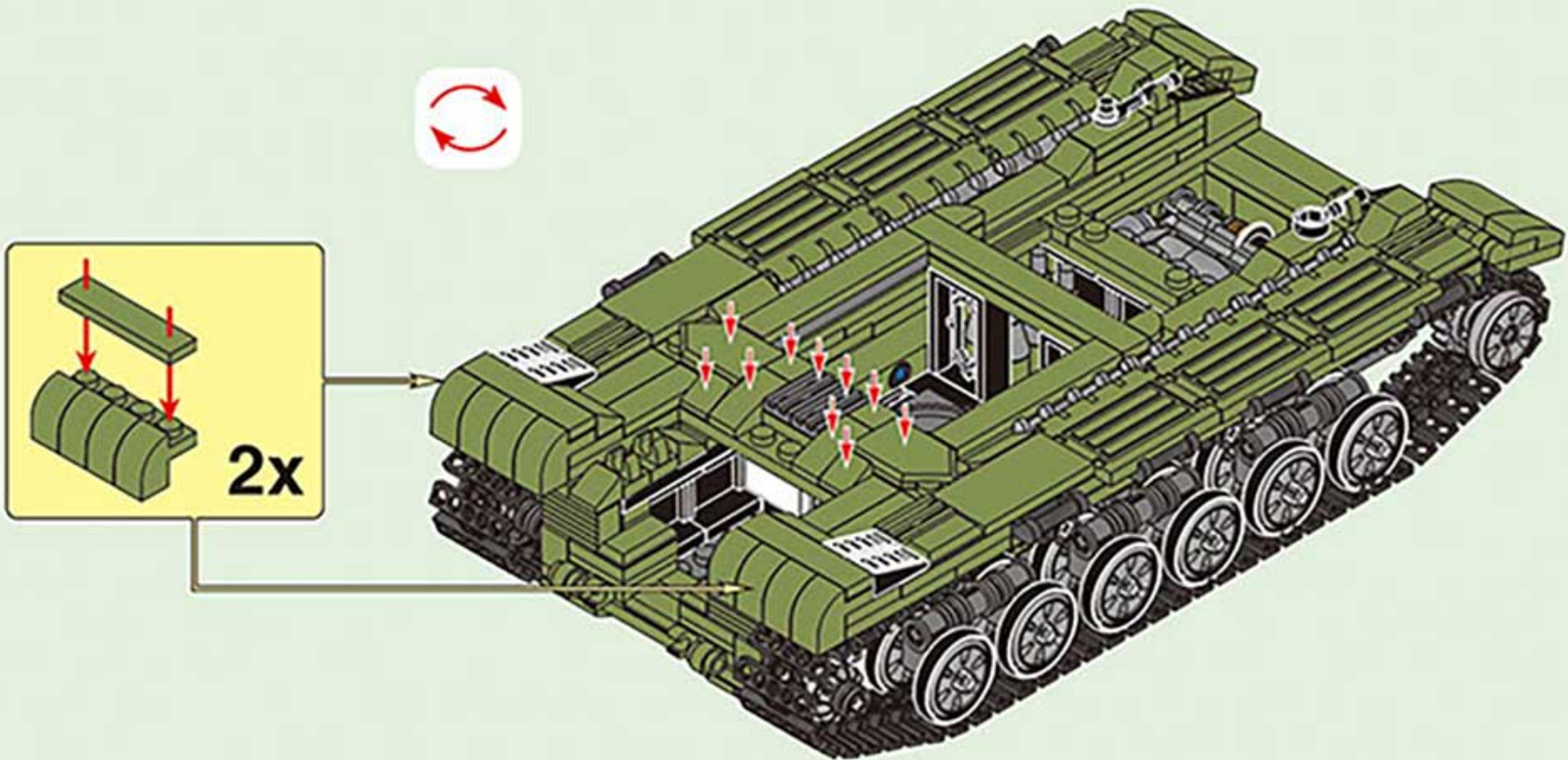



3



x4

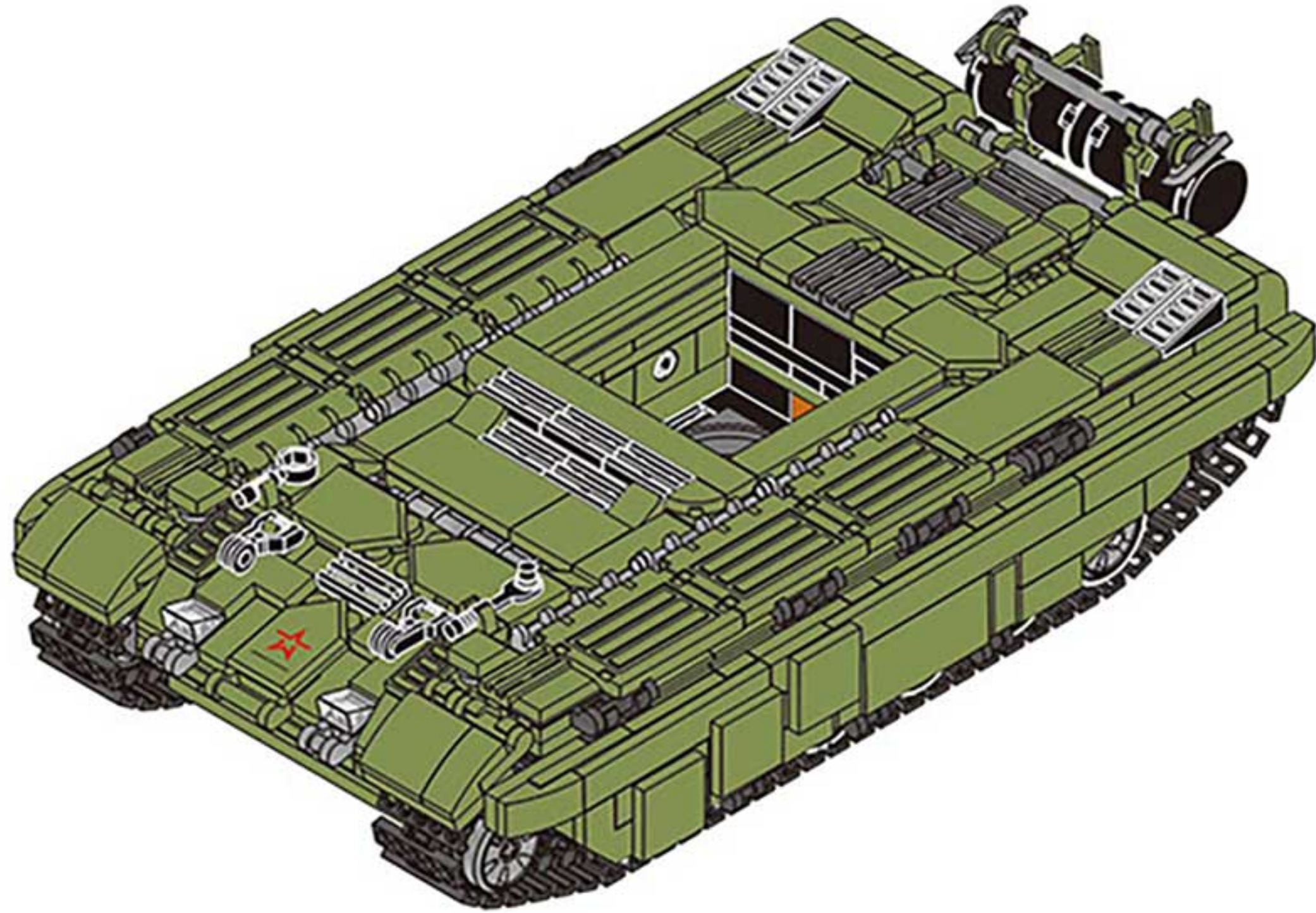

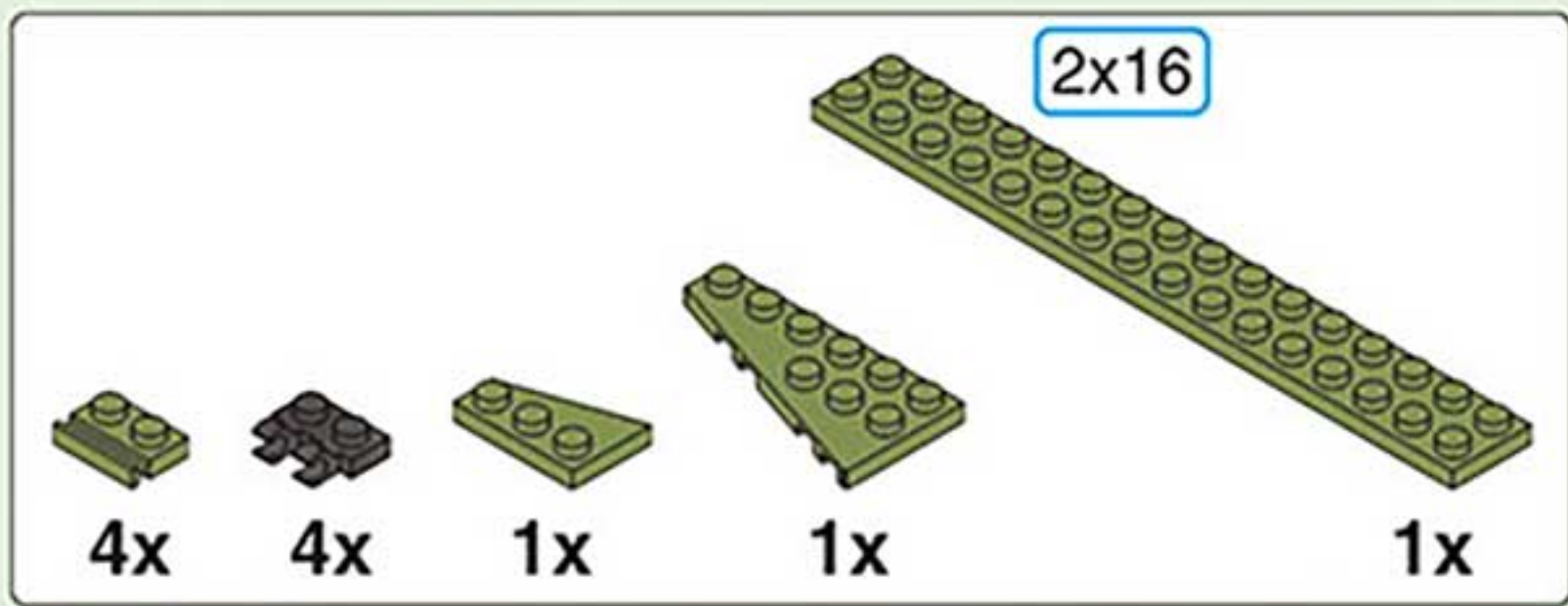

3-1.1

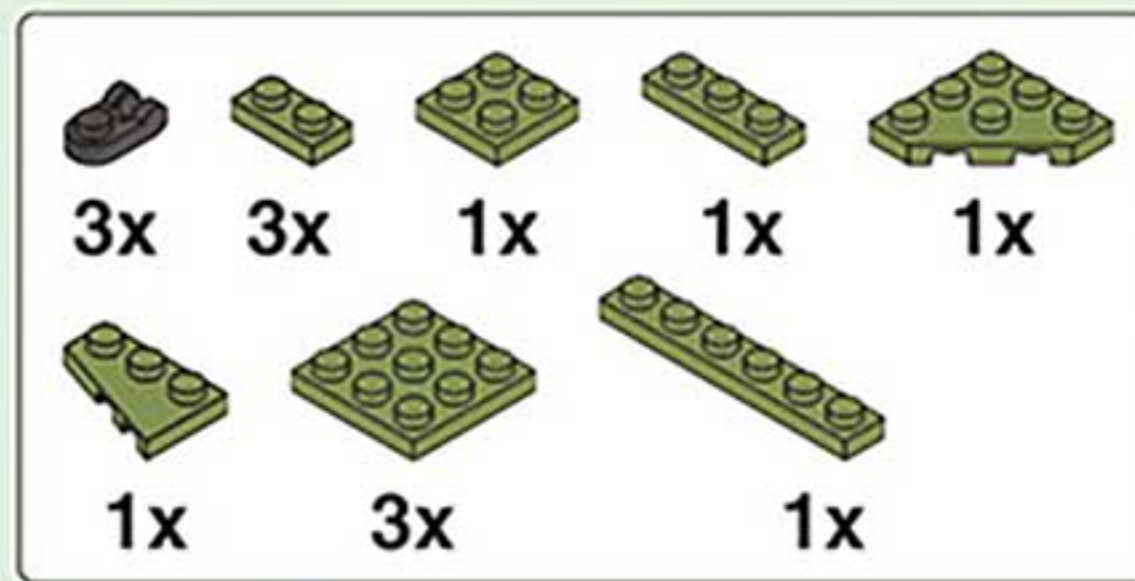
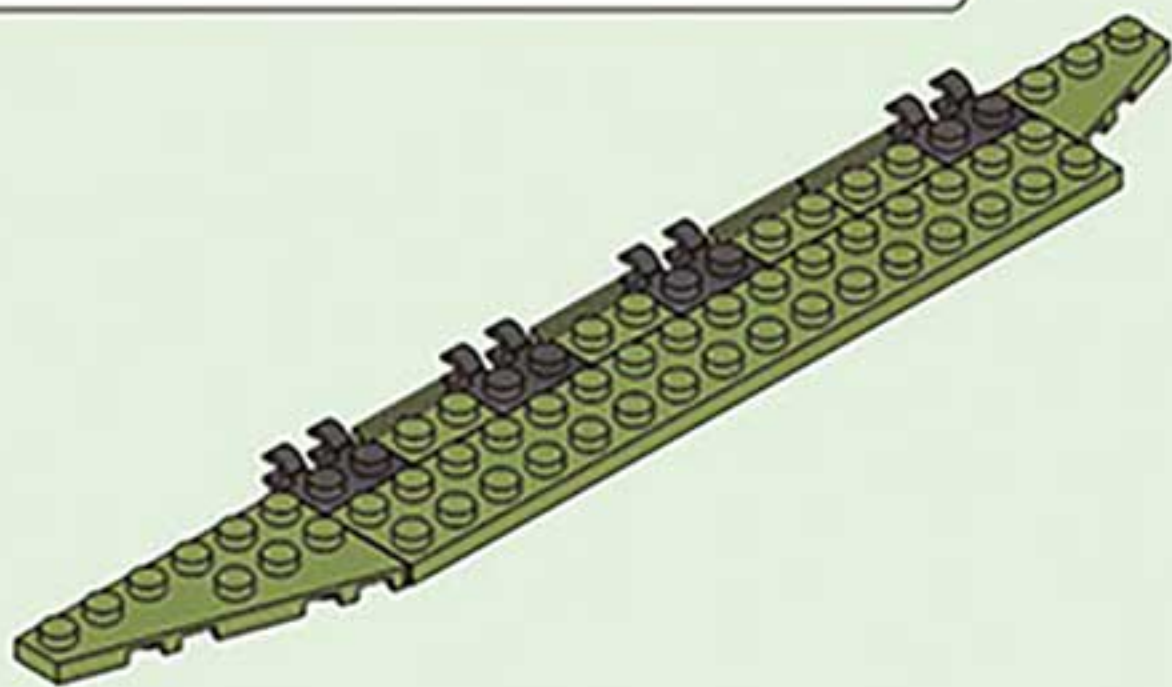

3-1.2

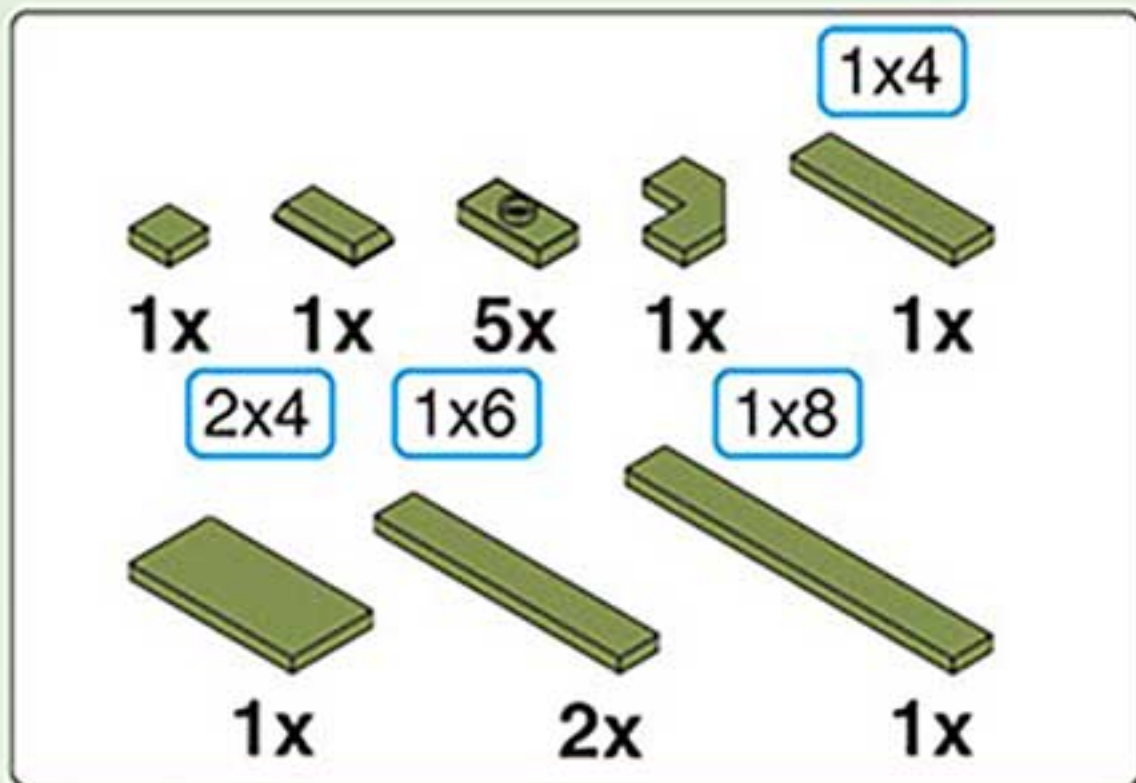
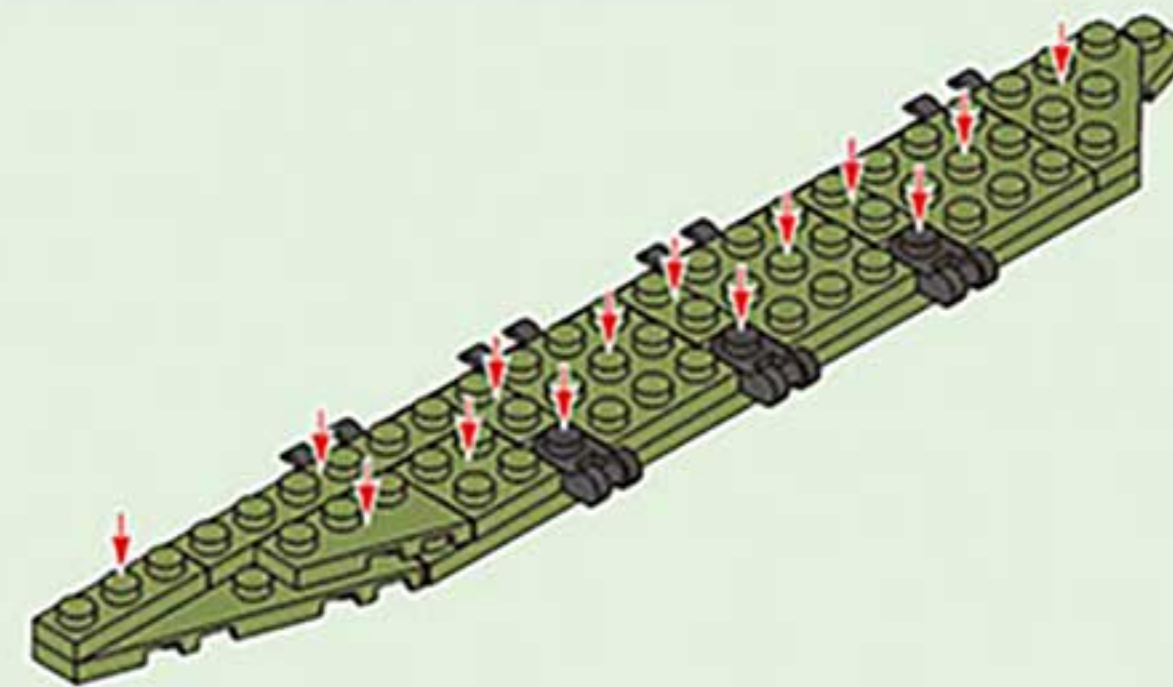

3-1.3

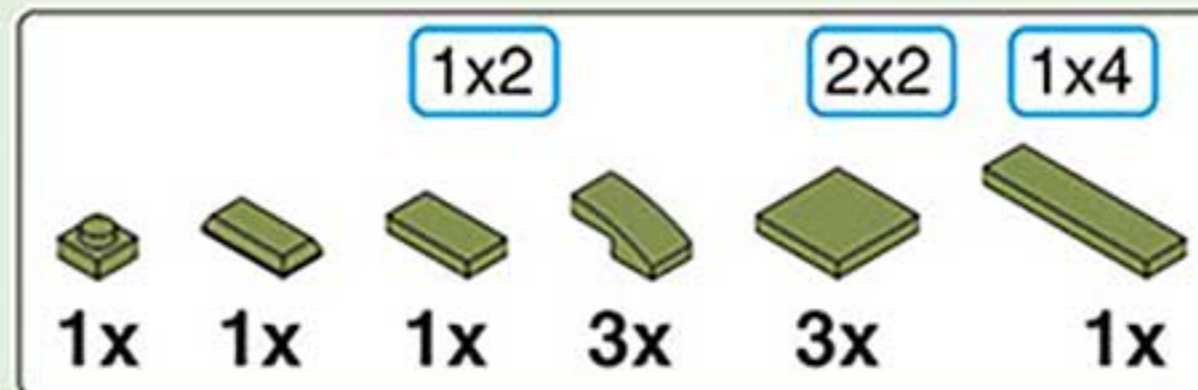
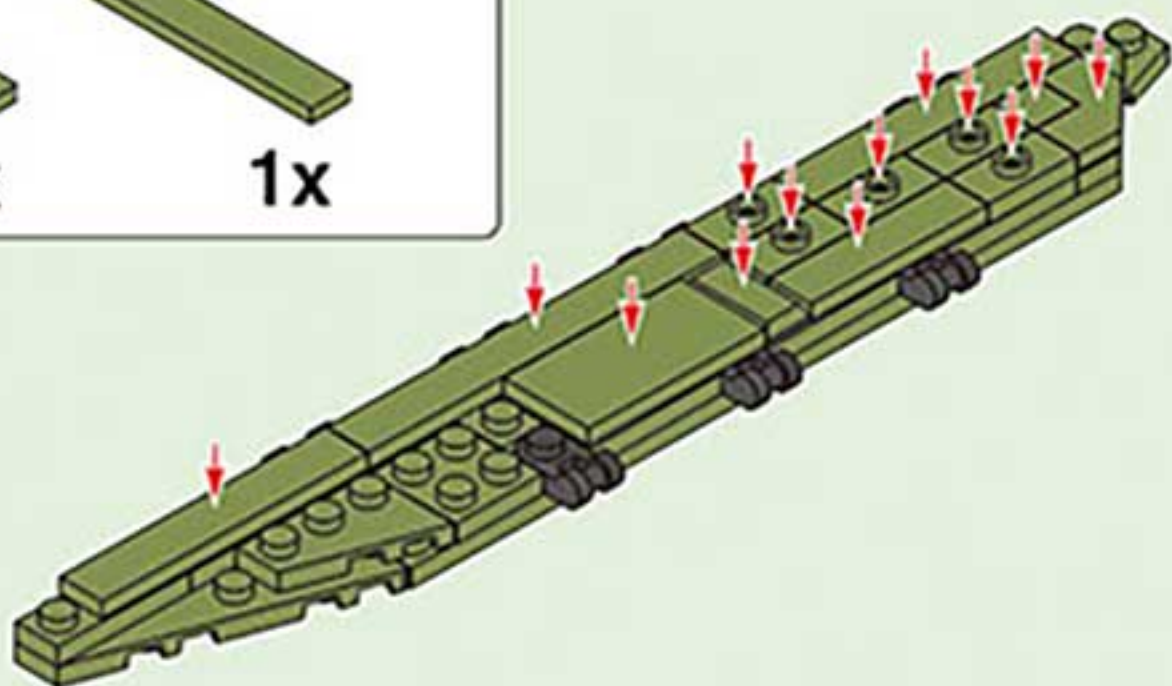

3-1.4

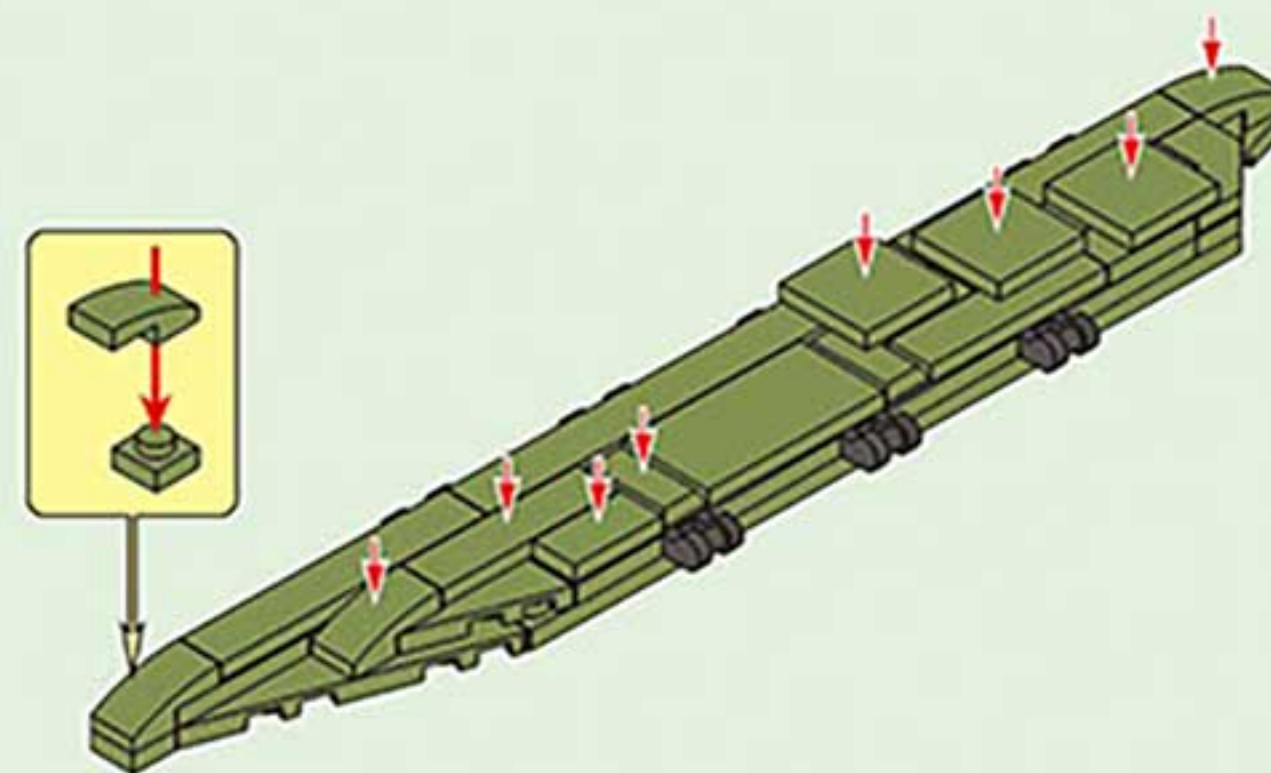

3-2

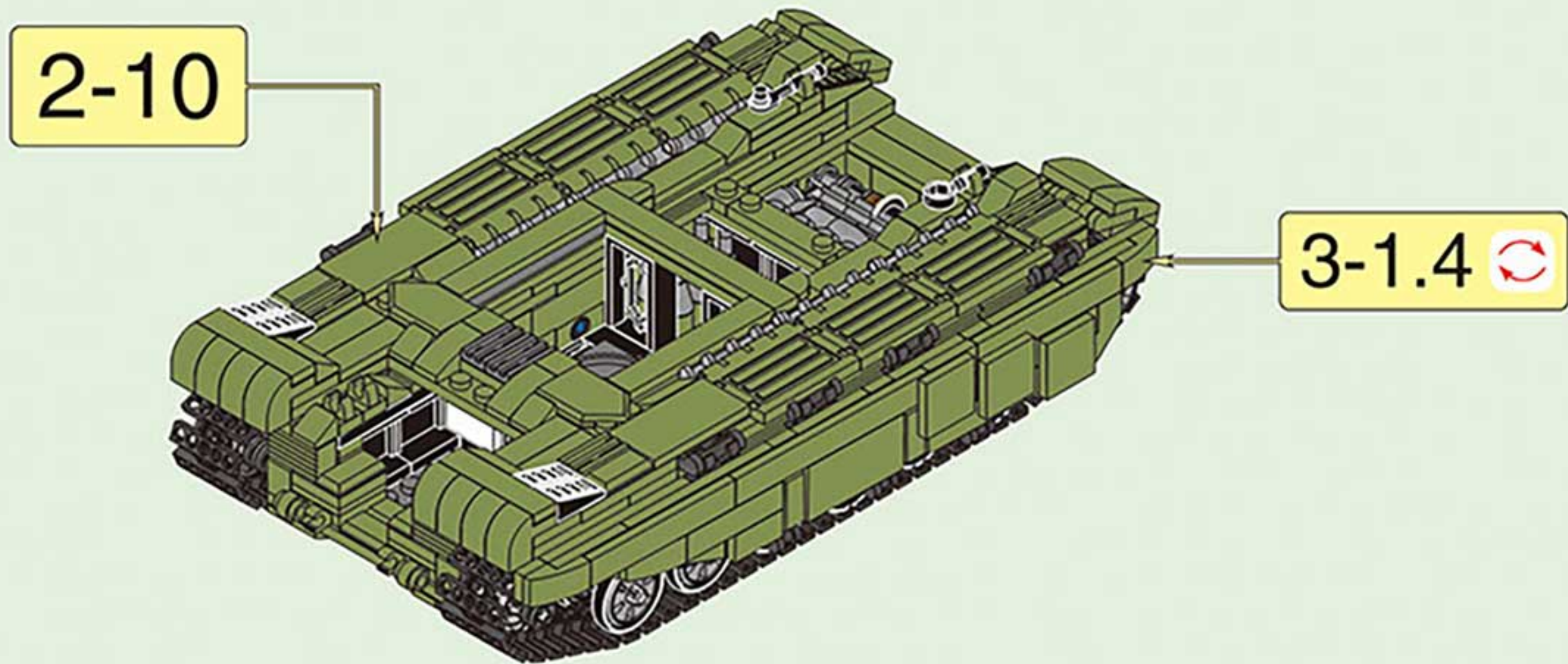

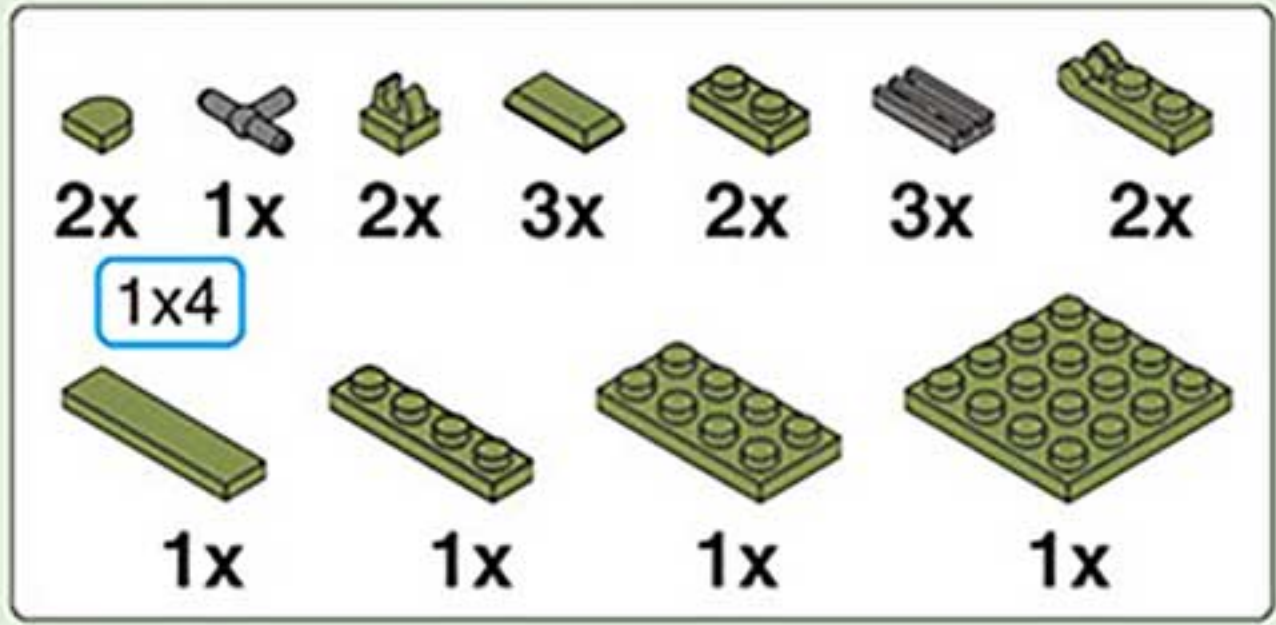

# 3-3

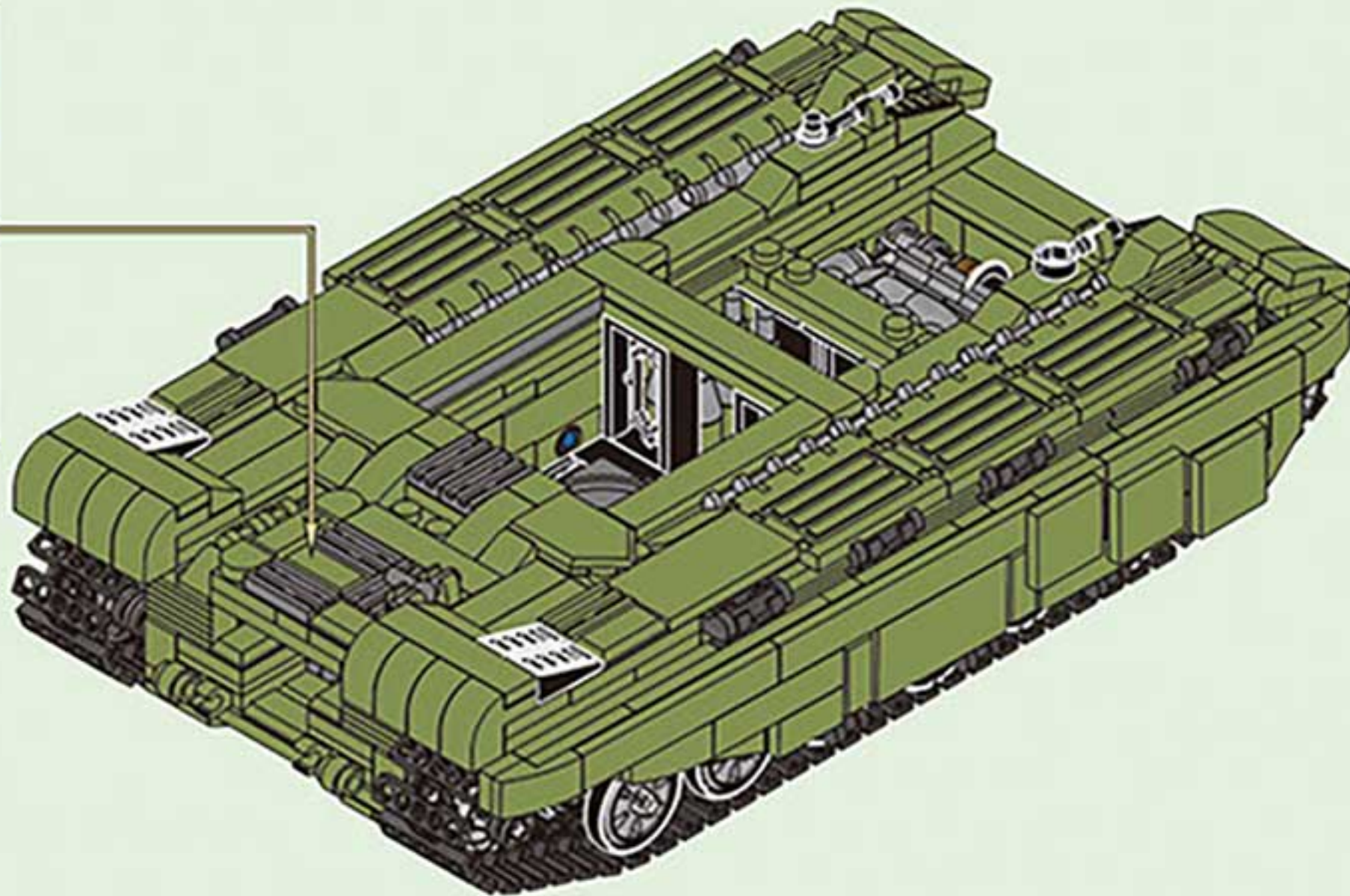
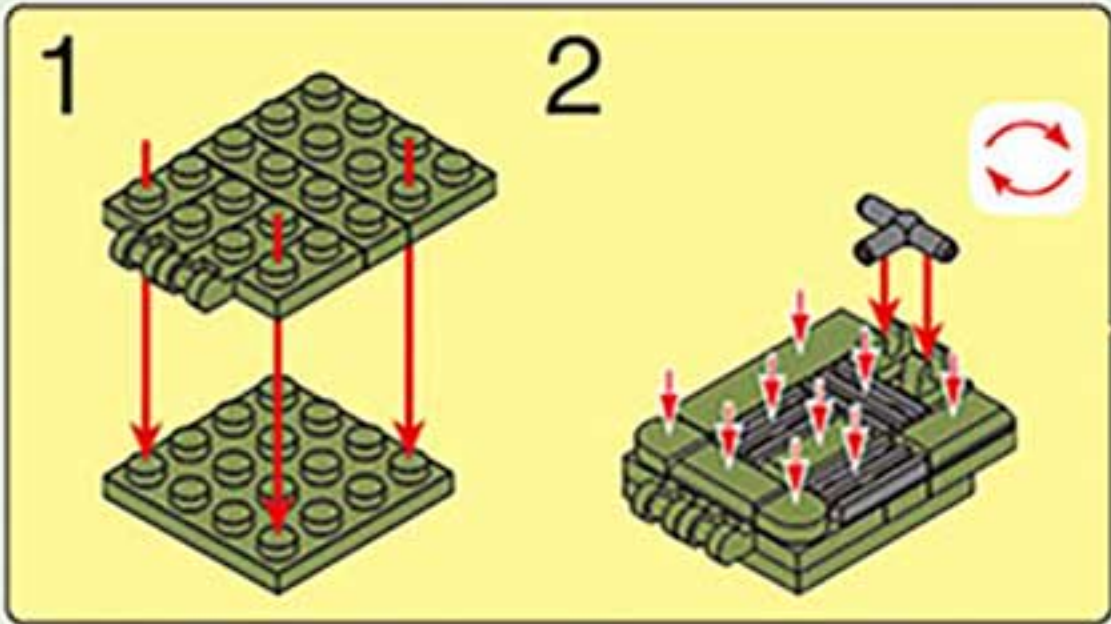

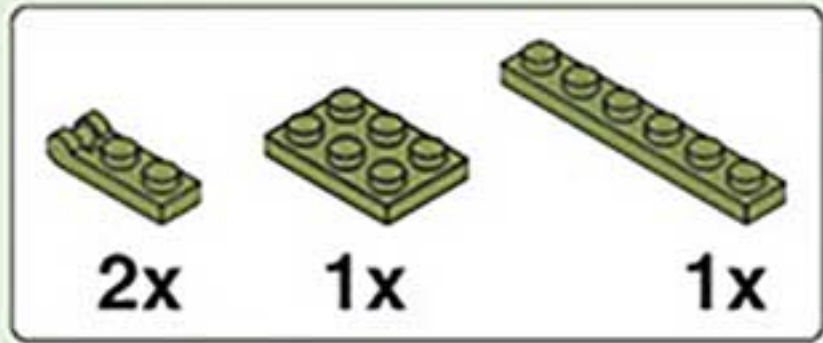

3-4.1

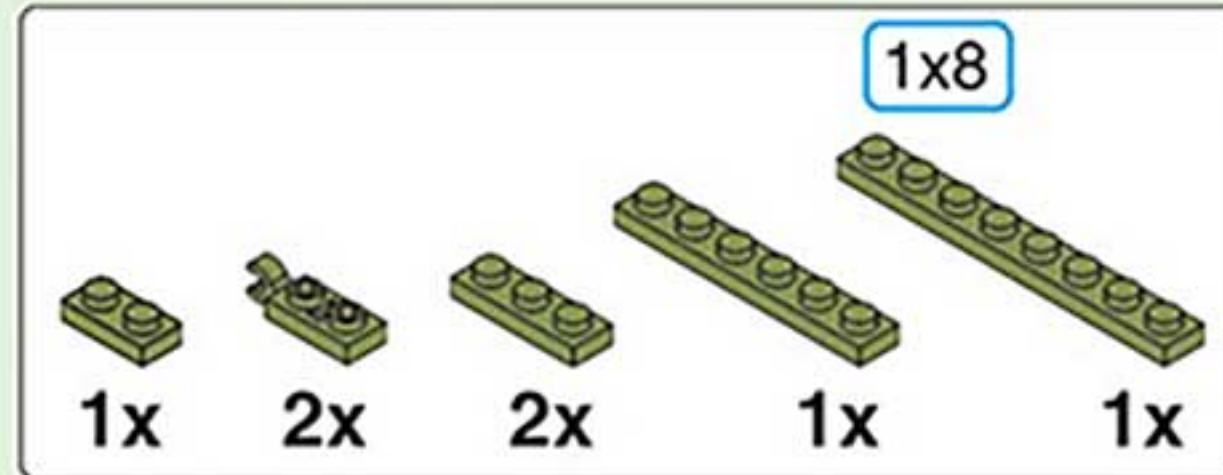
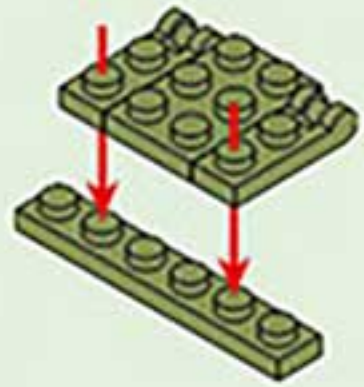

3-4.2

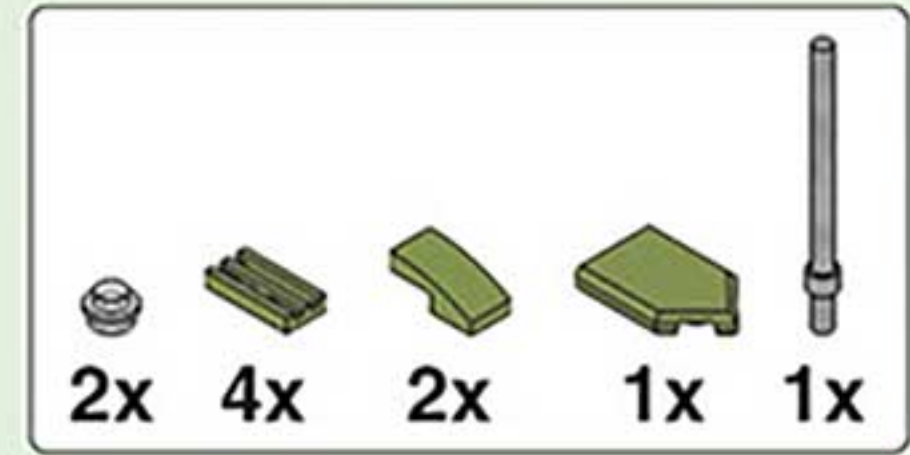
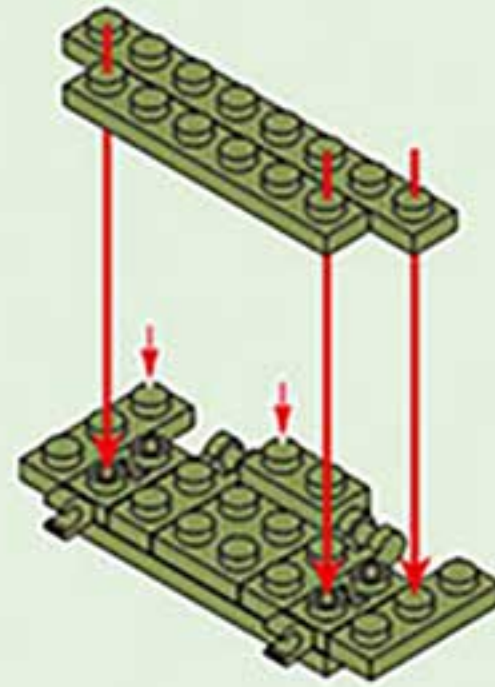

3-4.3

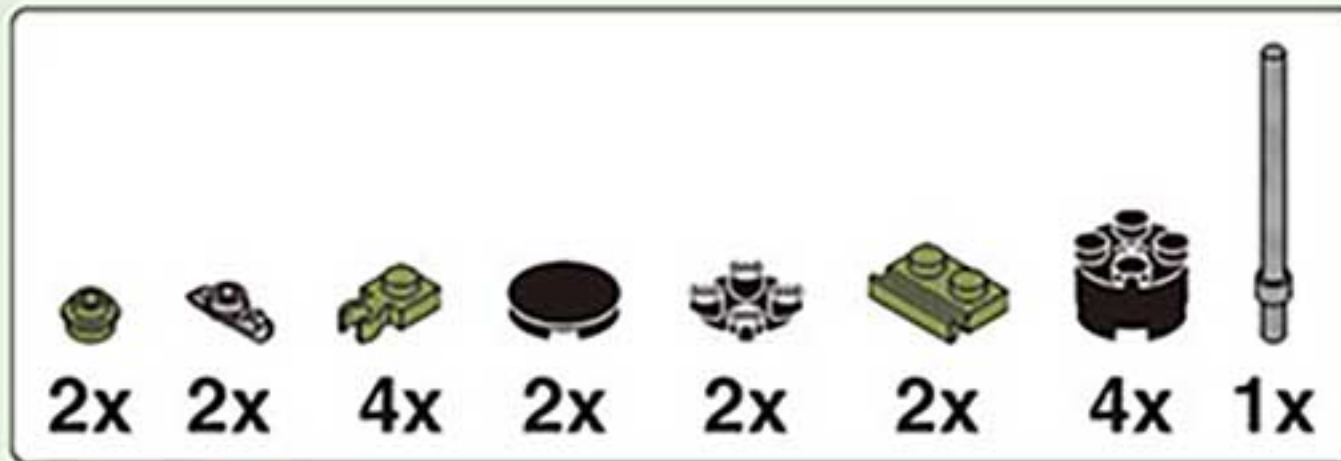
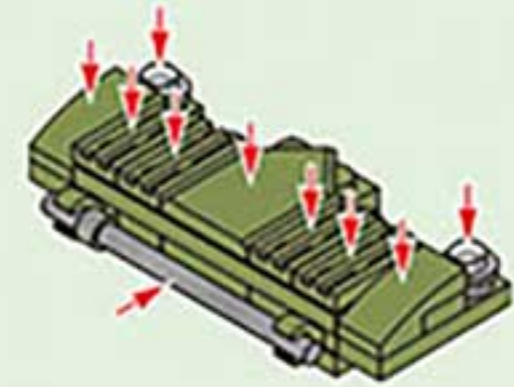

3-4.4

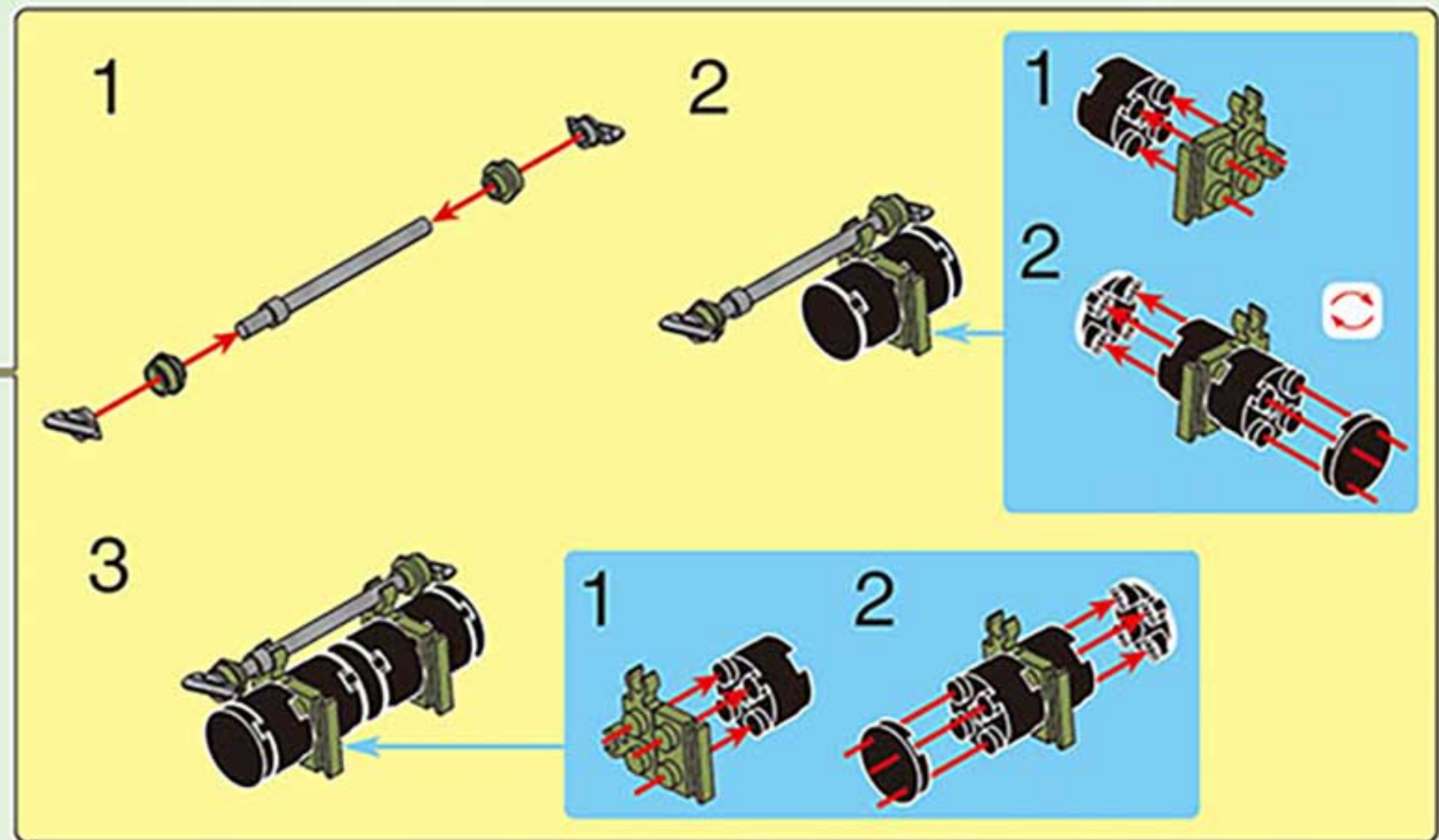

3-5

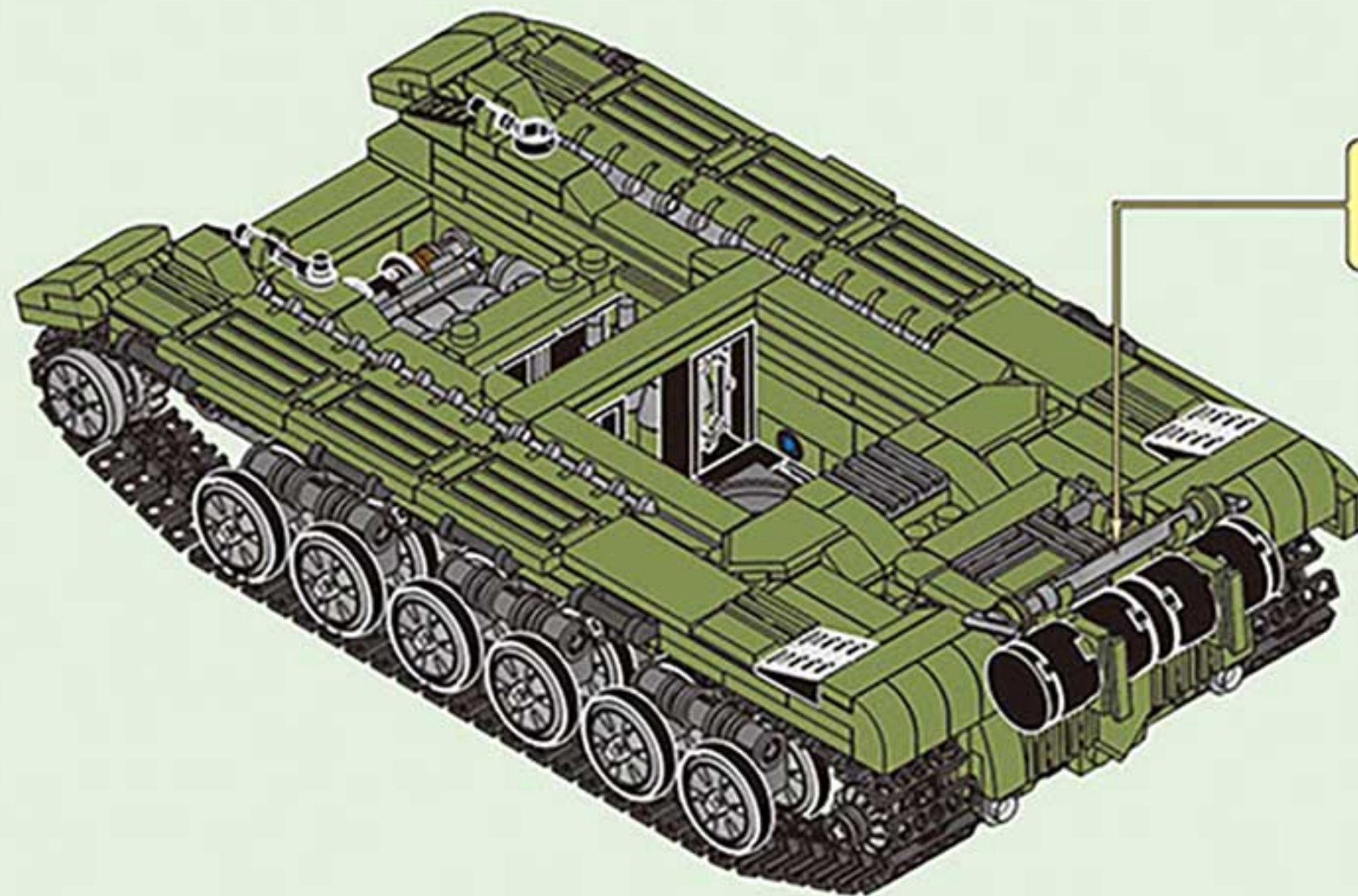

3-4.4 

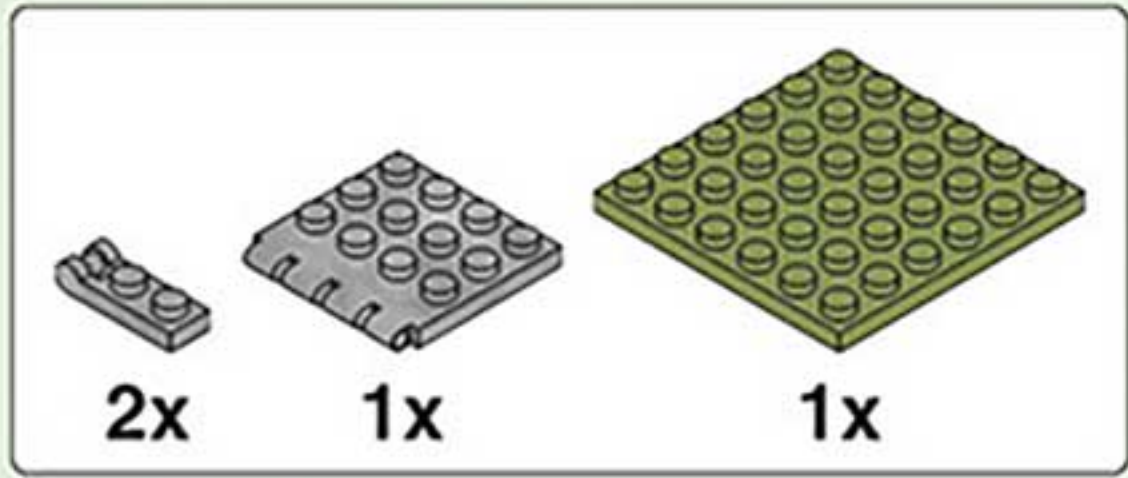

3-6.1

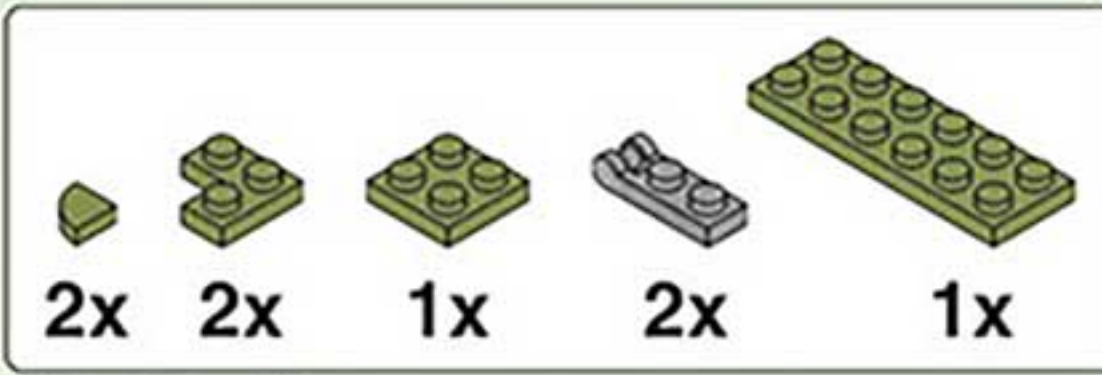
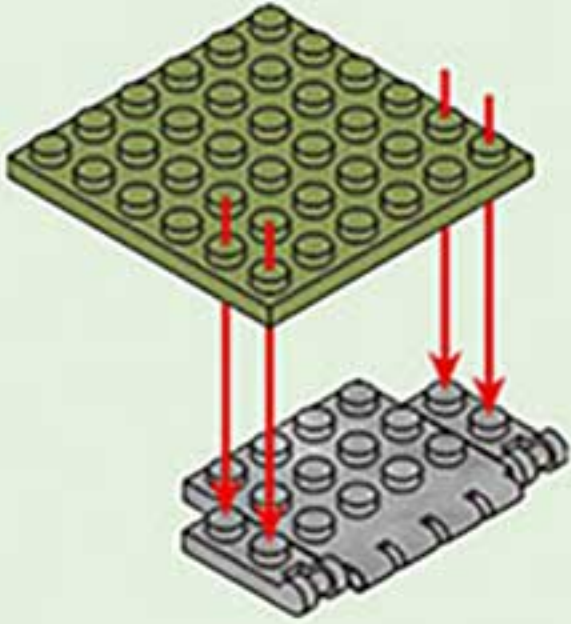

3-6.2

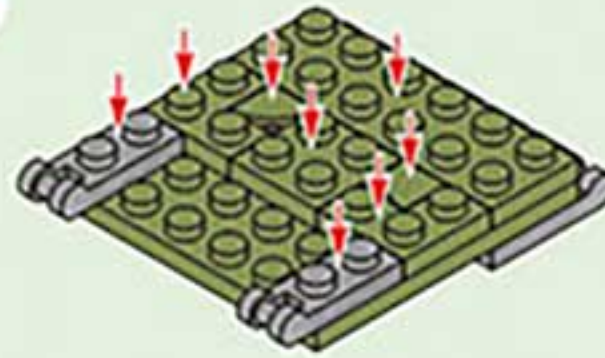

3-6.3

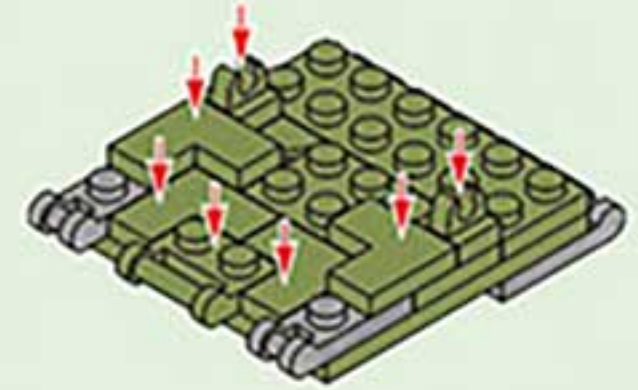

3-6.4

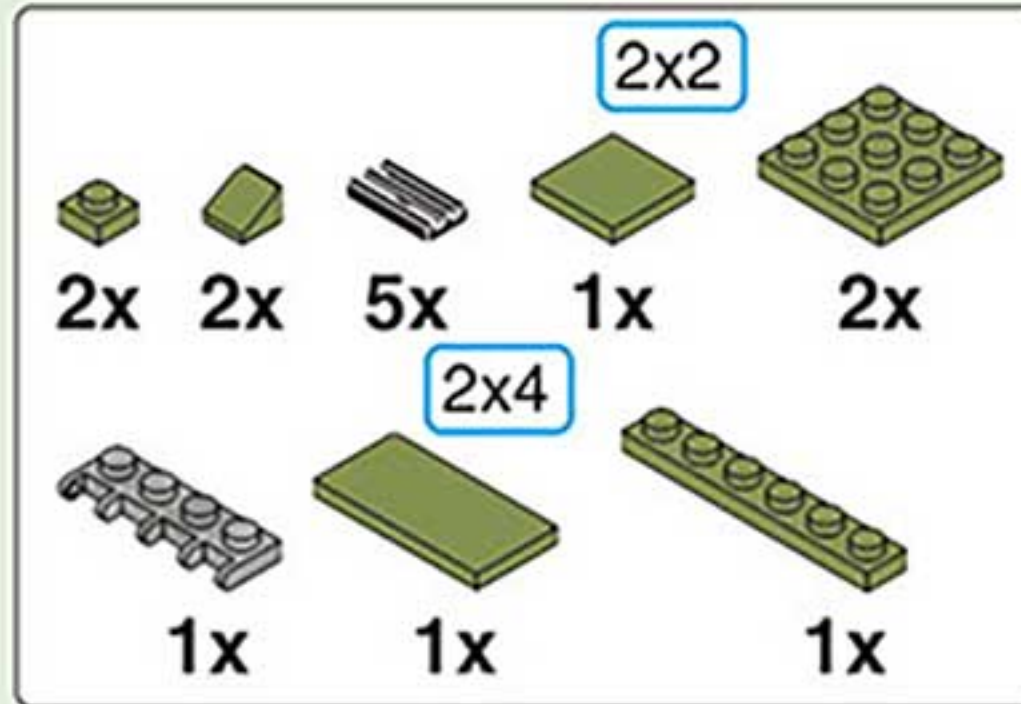
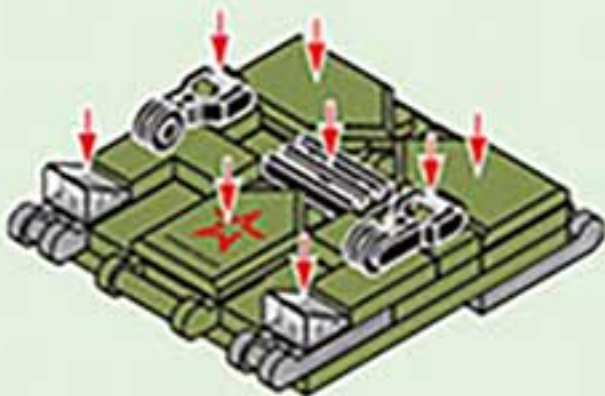

3-6.5

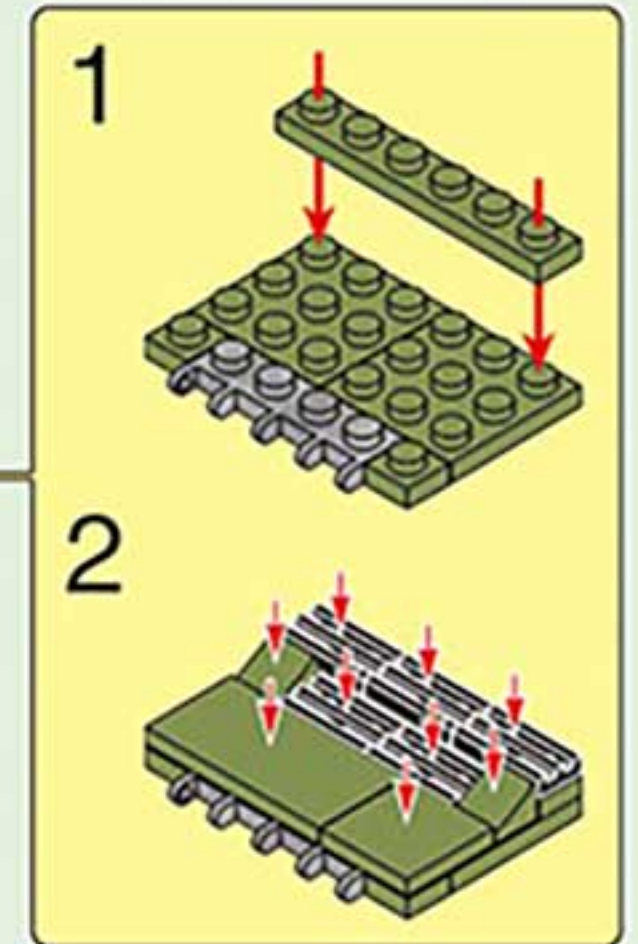
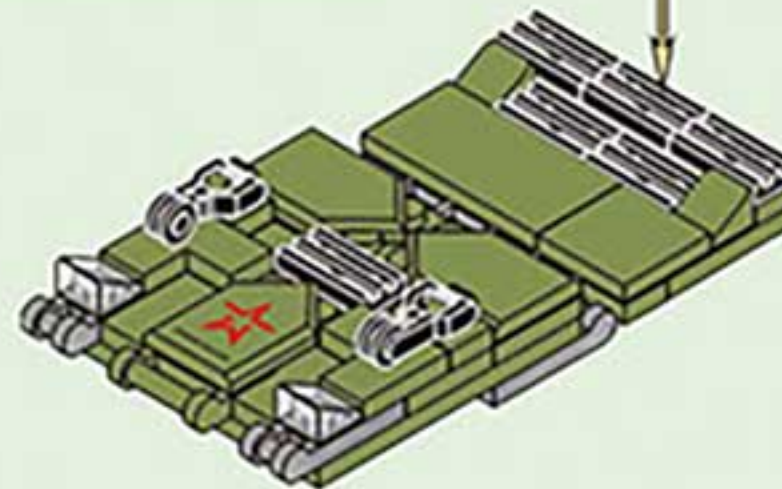

3-7



3-6.5

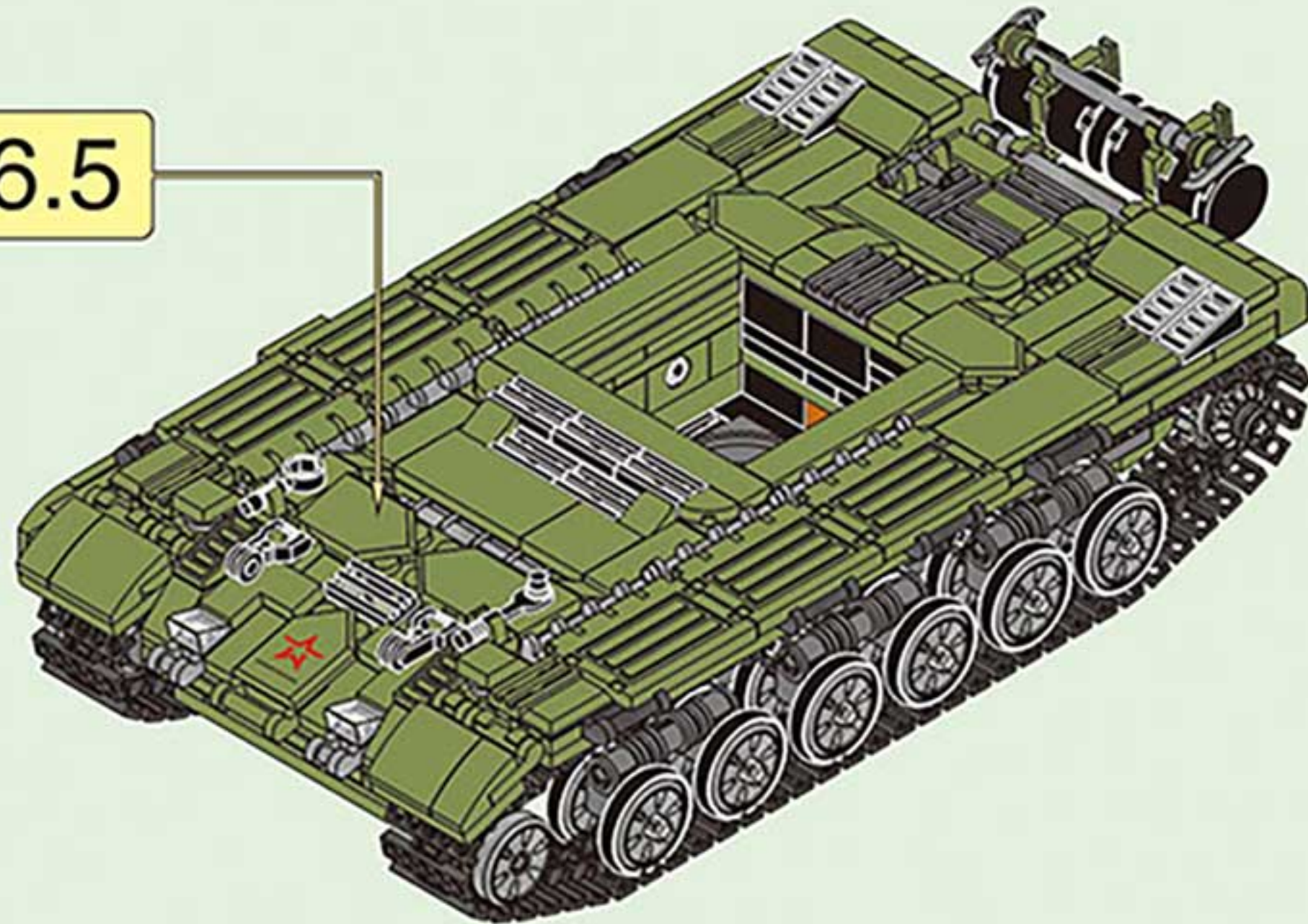

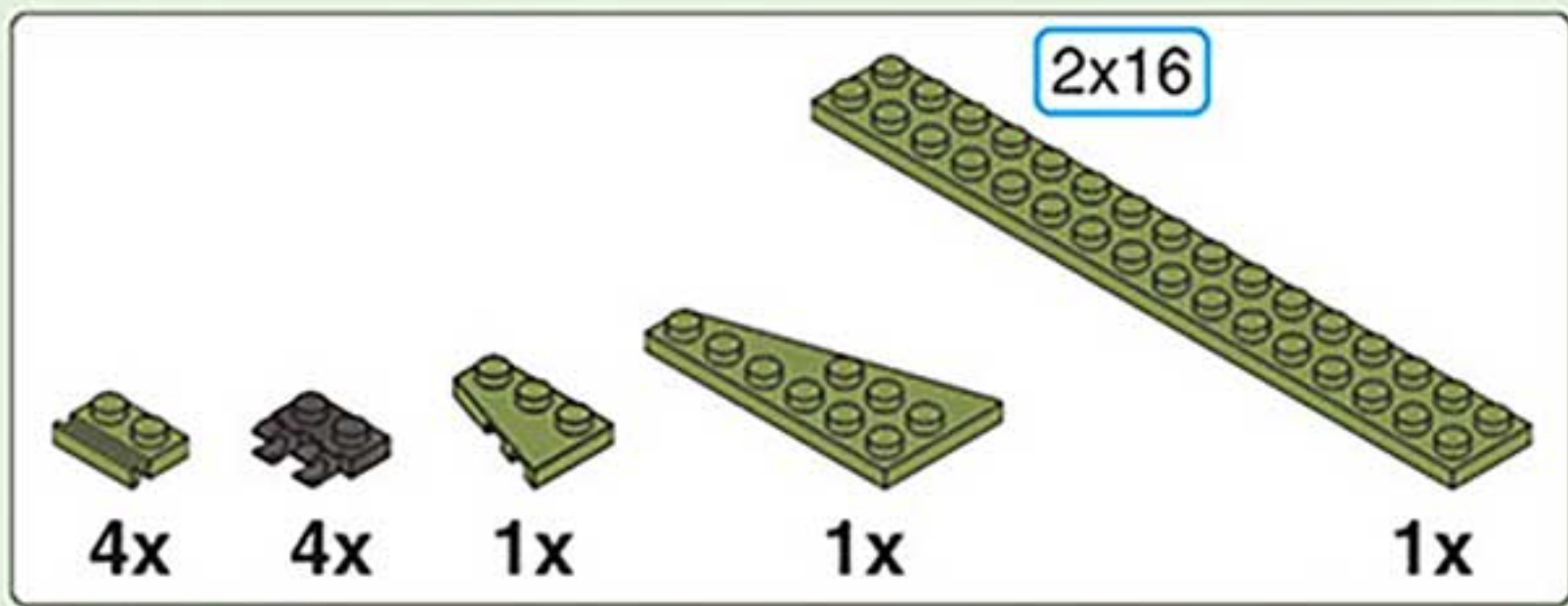

3-7.1

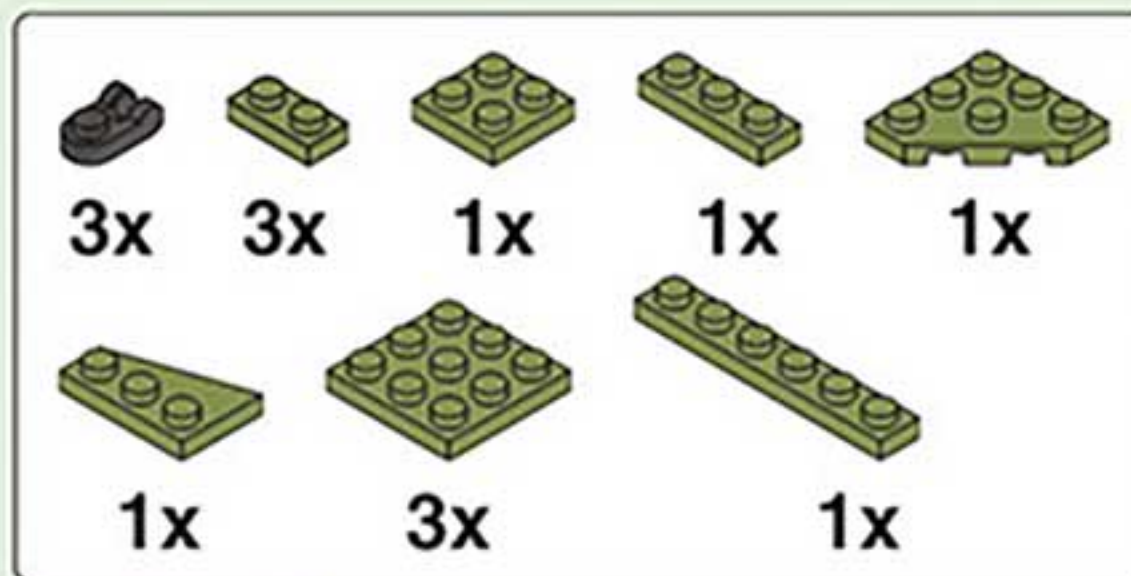
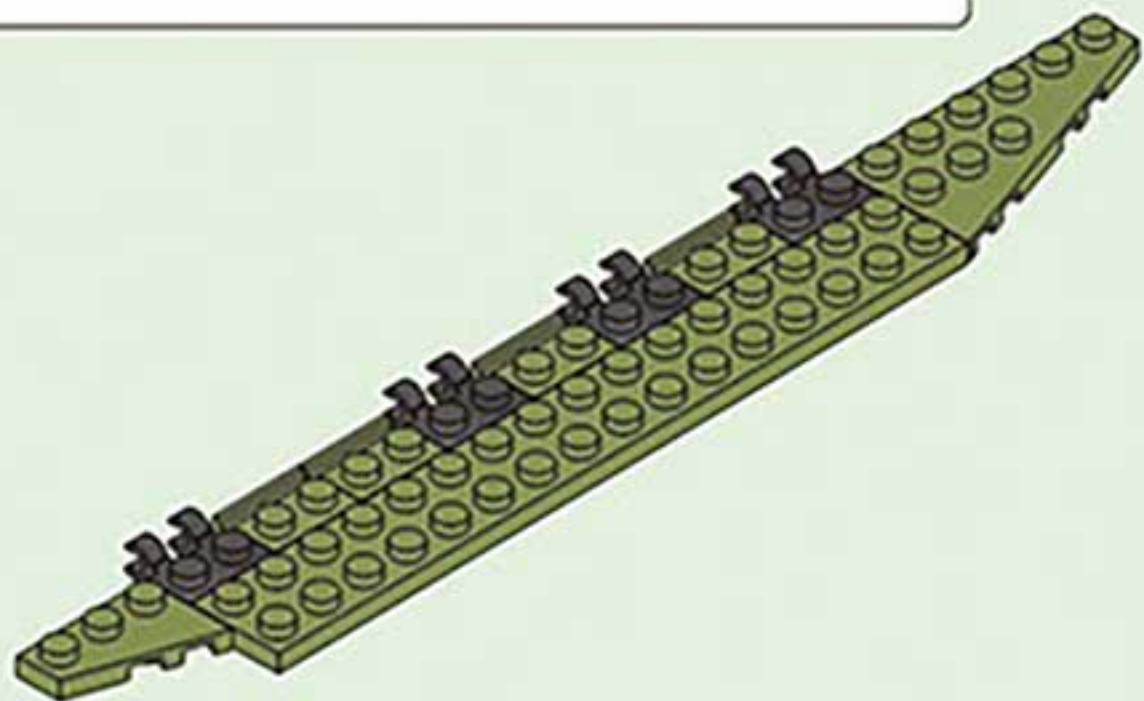

3-7.2

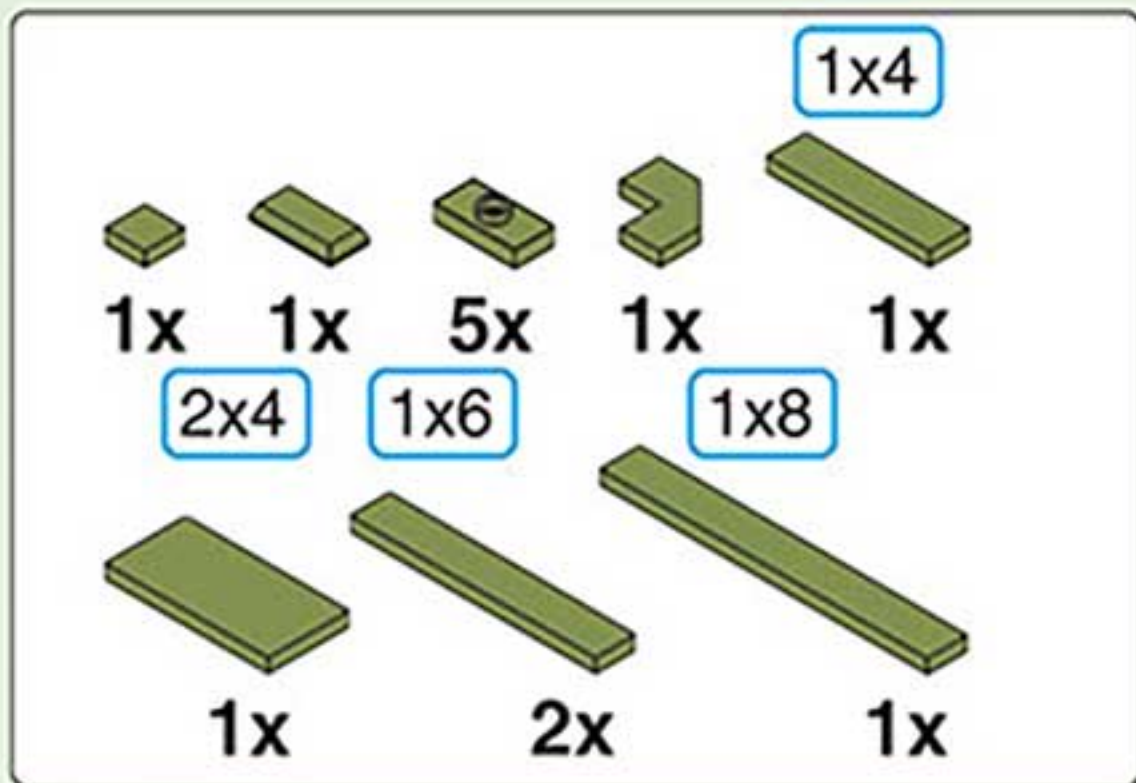
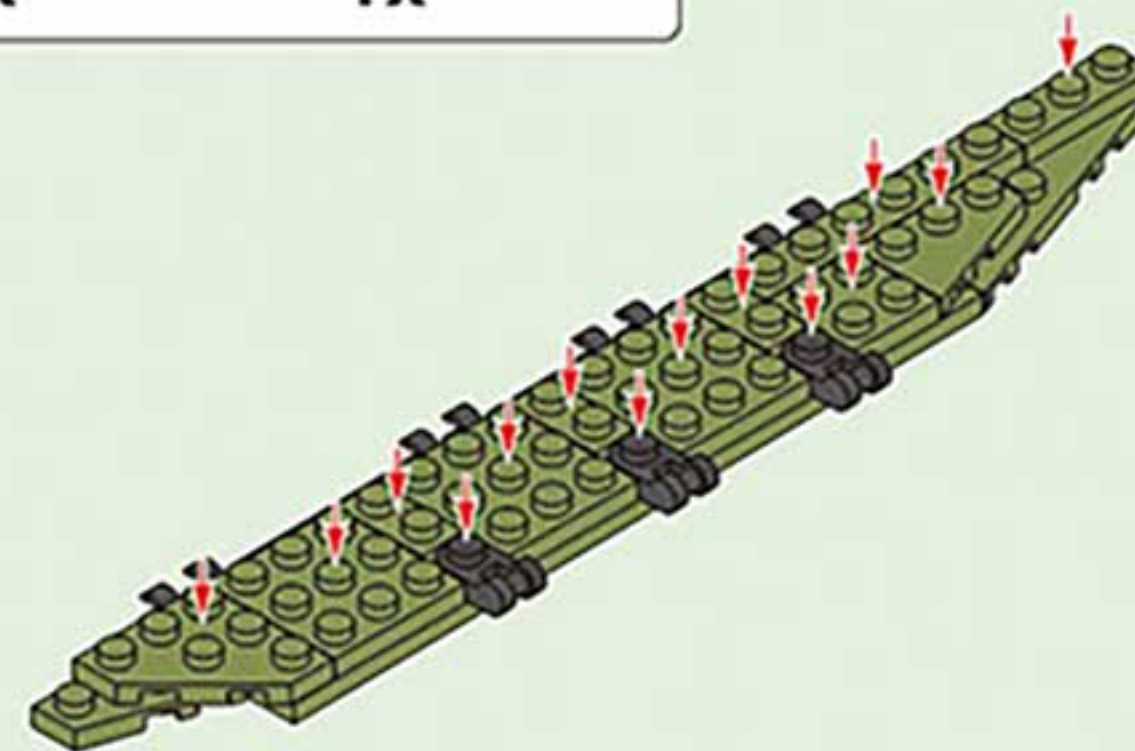

3-7.3

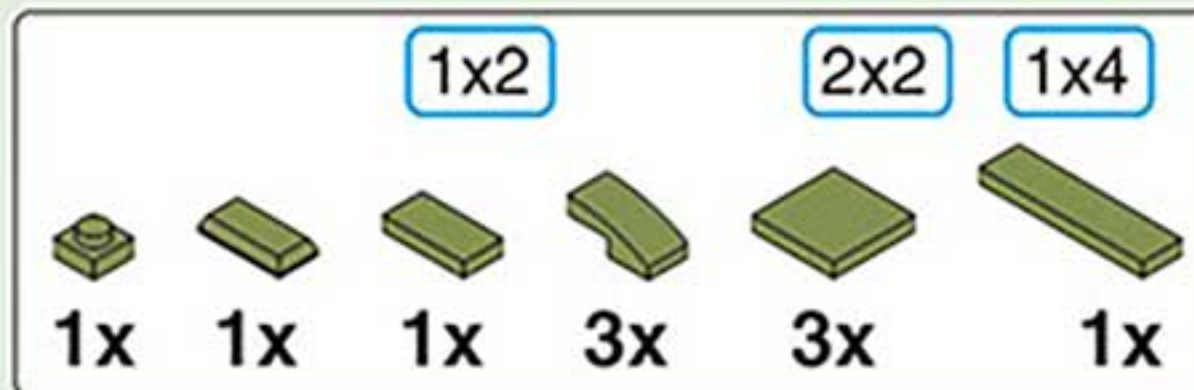
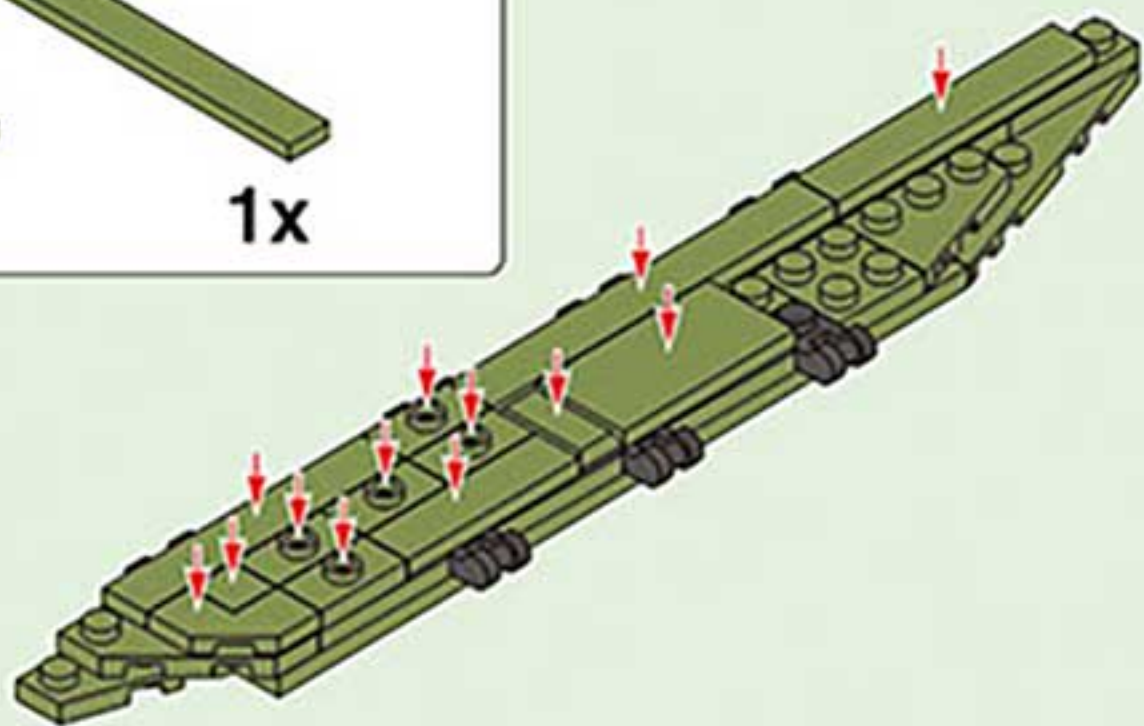

3-7.4

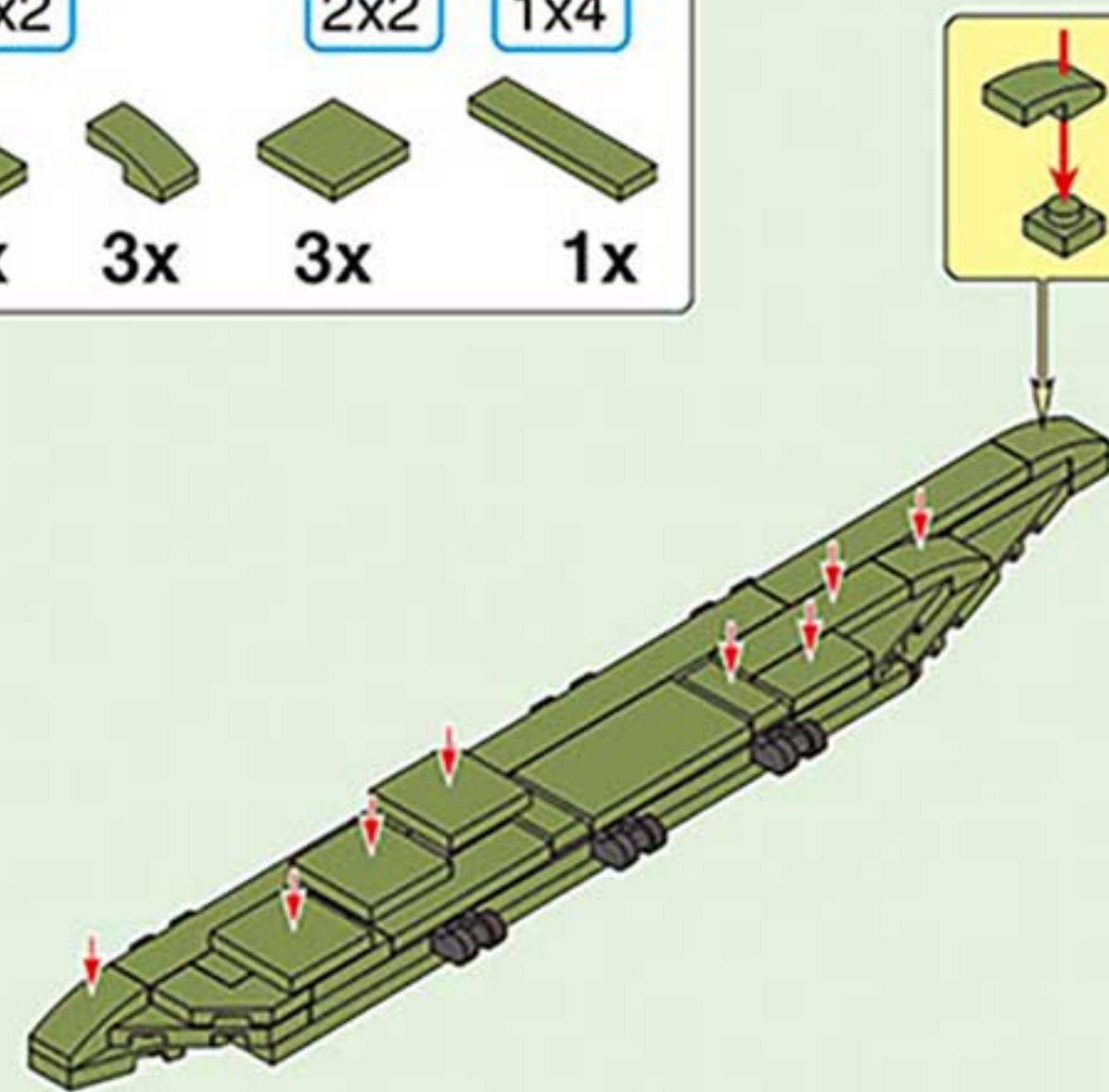

3-8

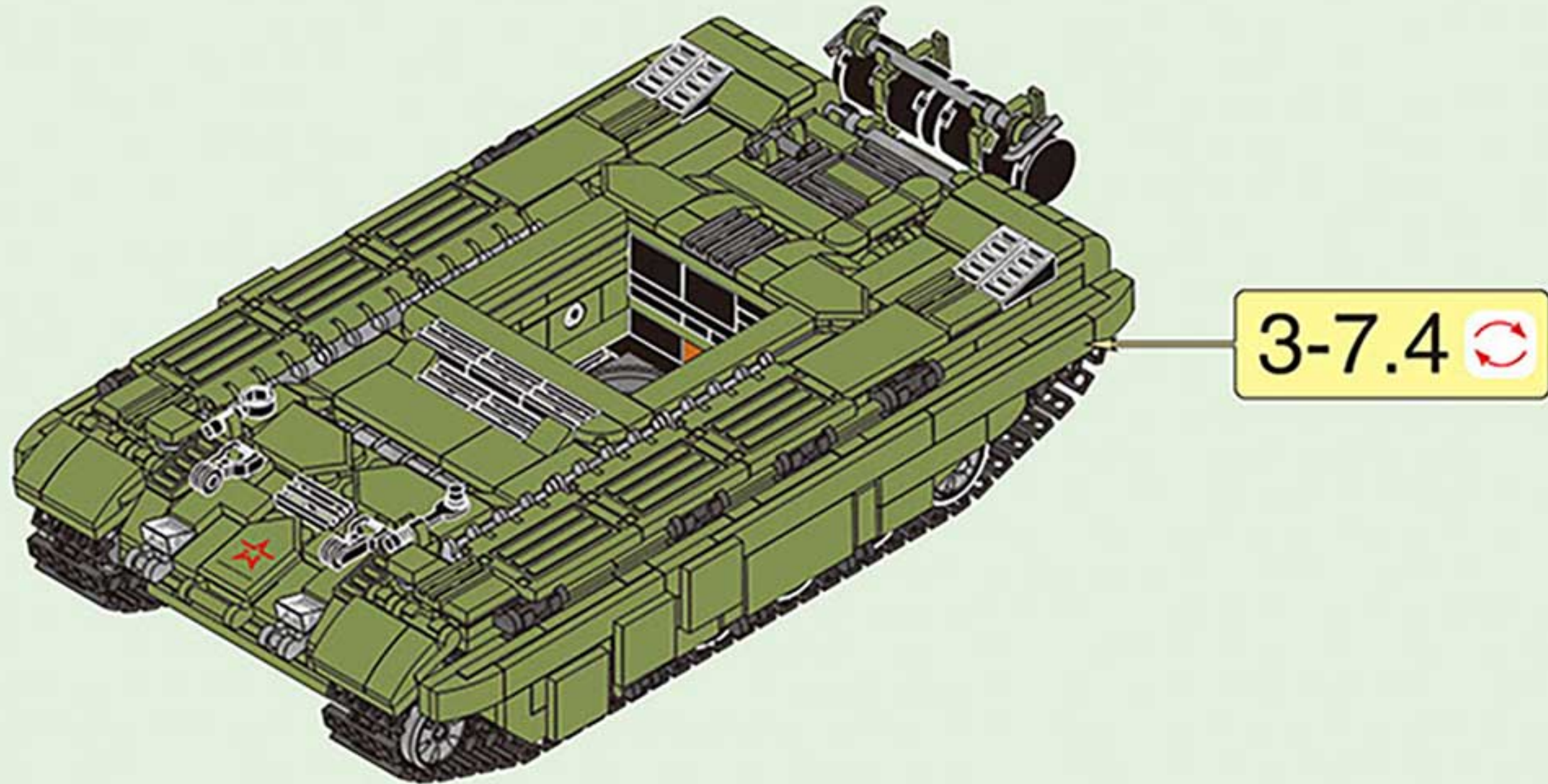



4



x5

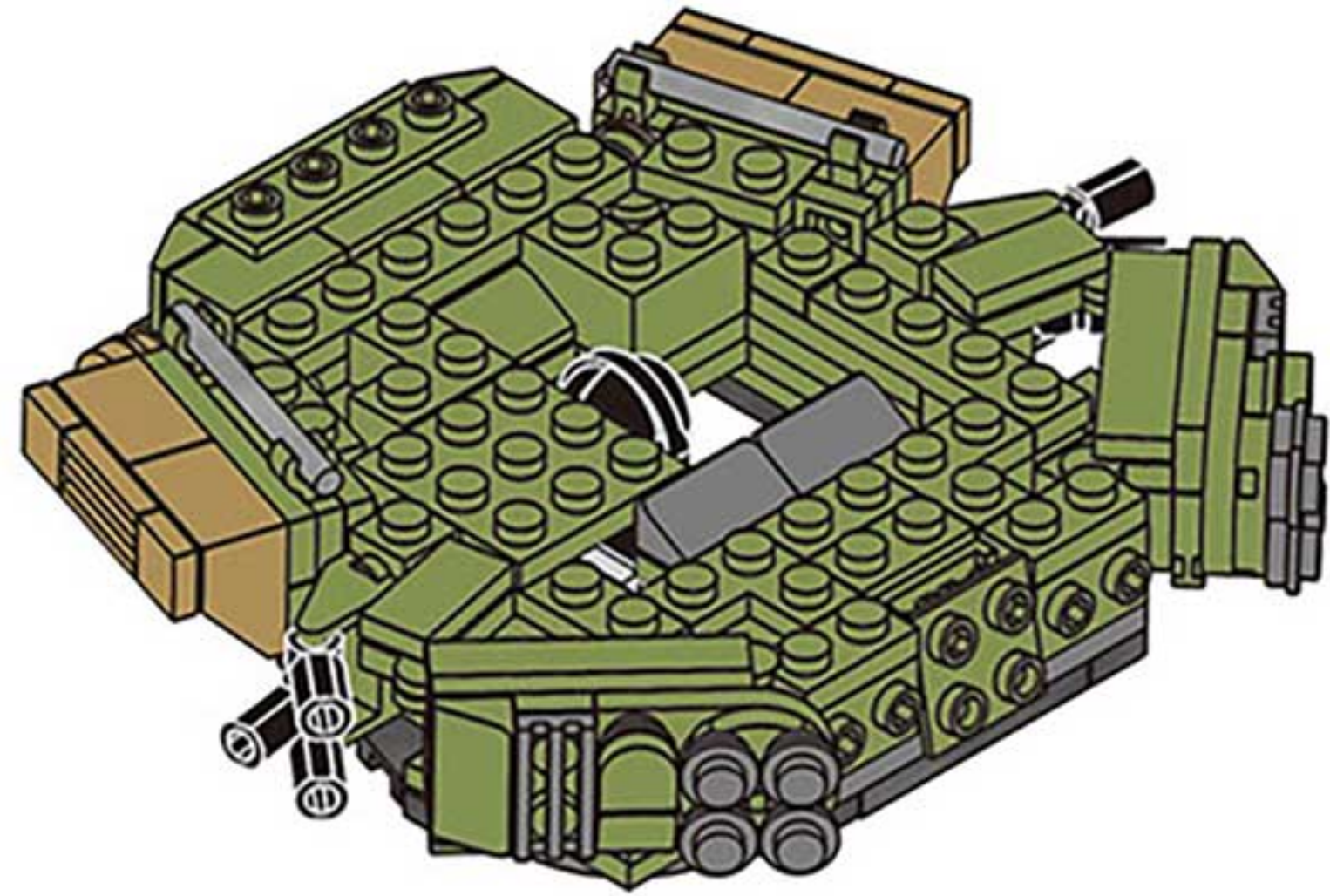

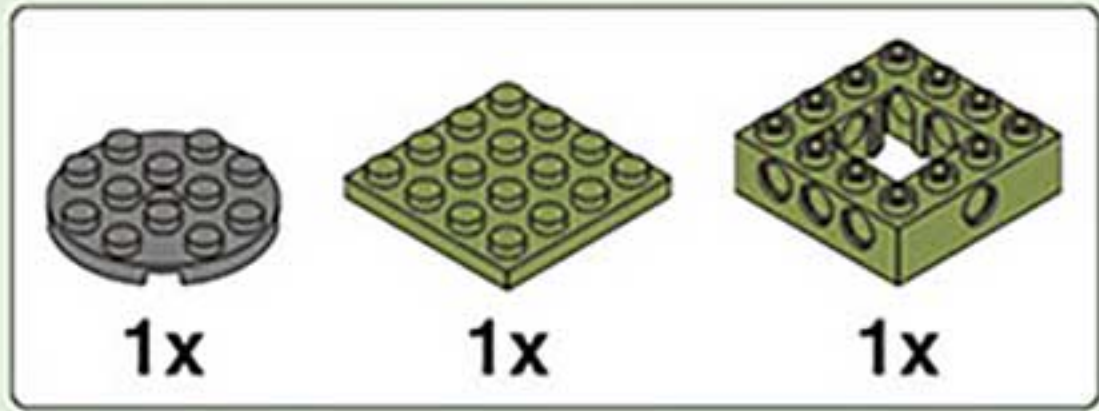

4-1

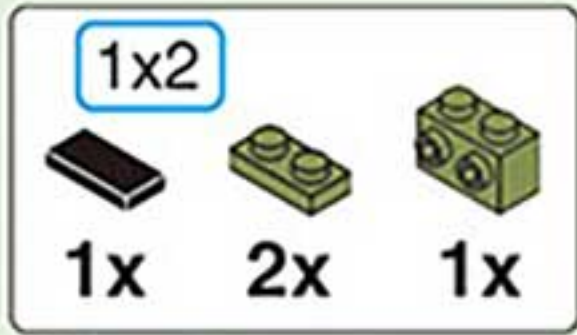
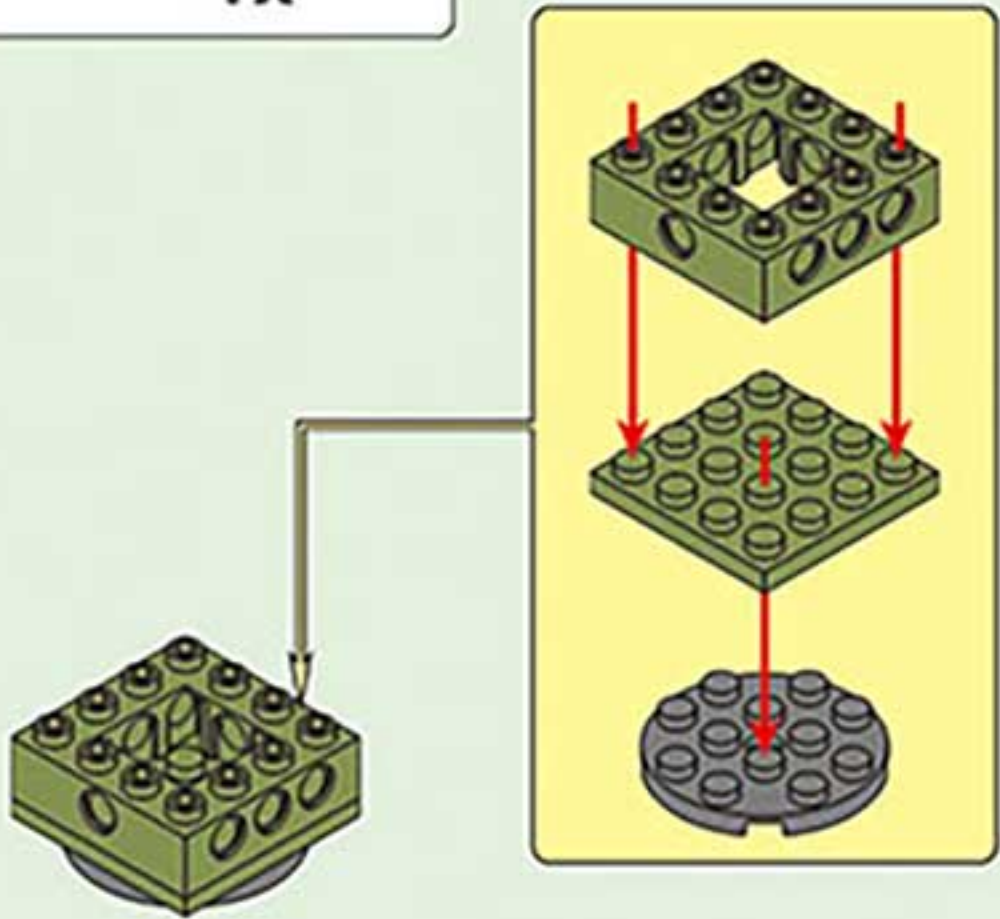

4-2

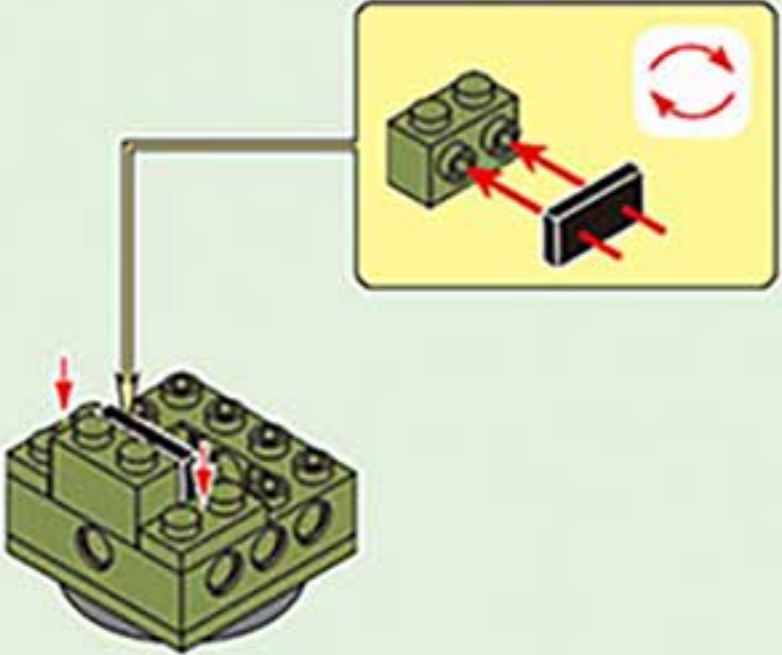

4-3

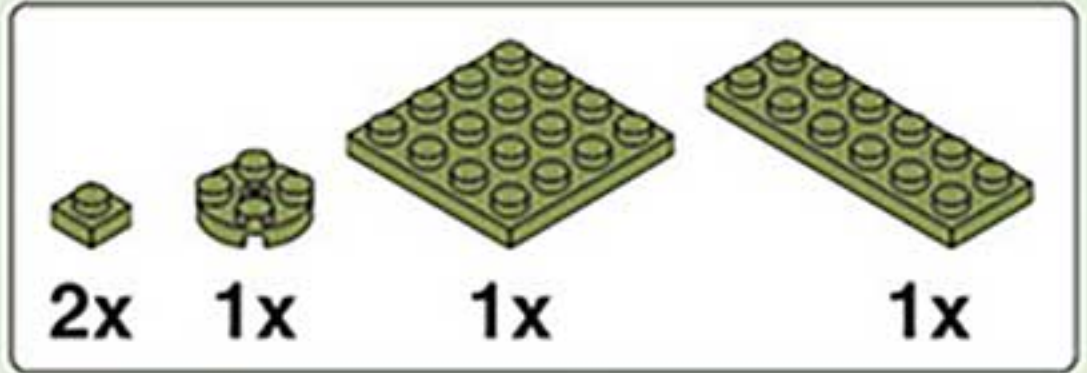
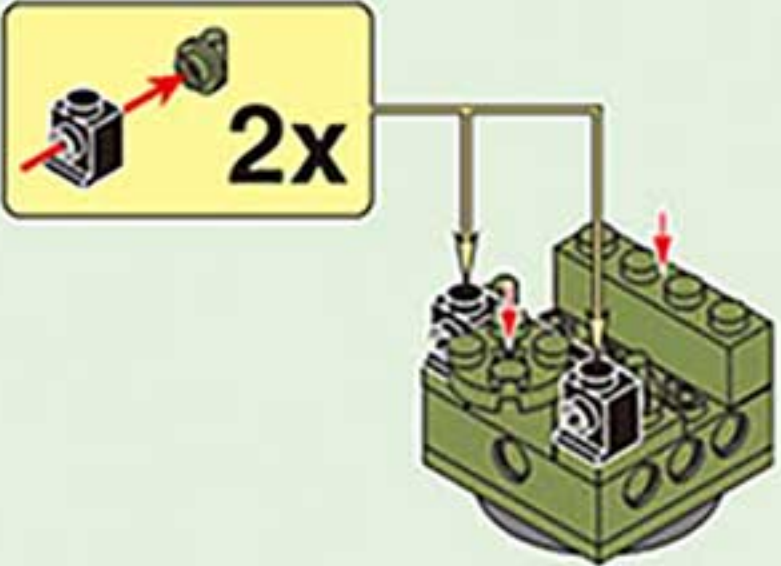

4-4

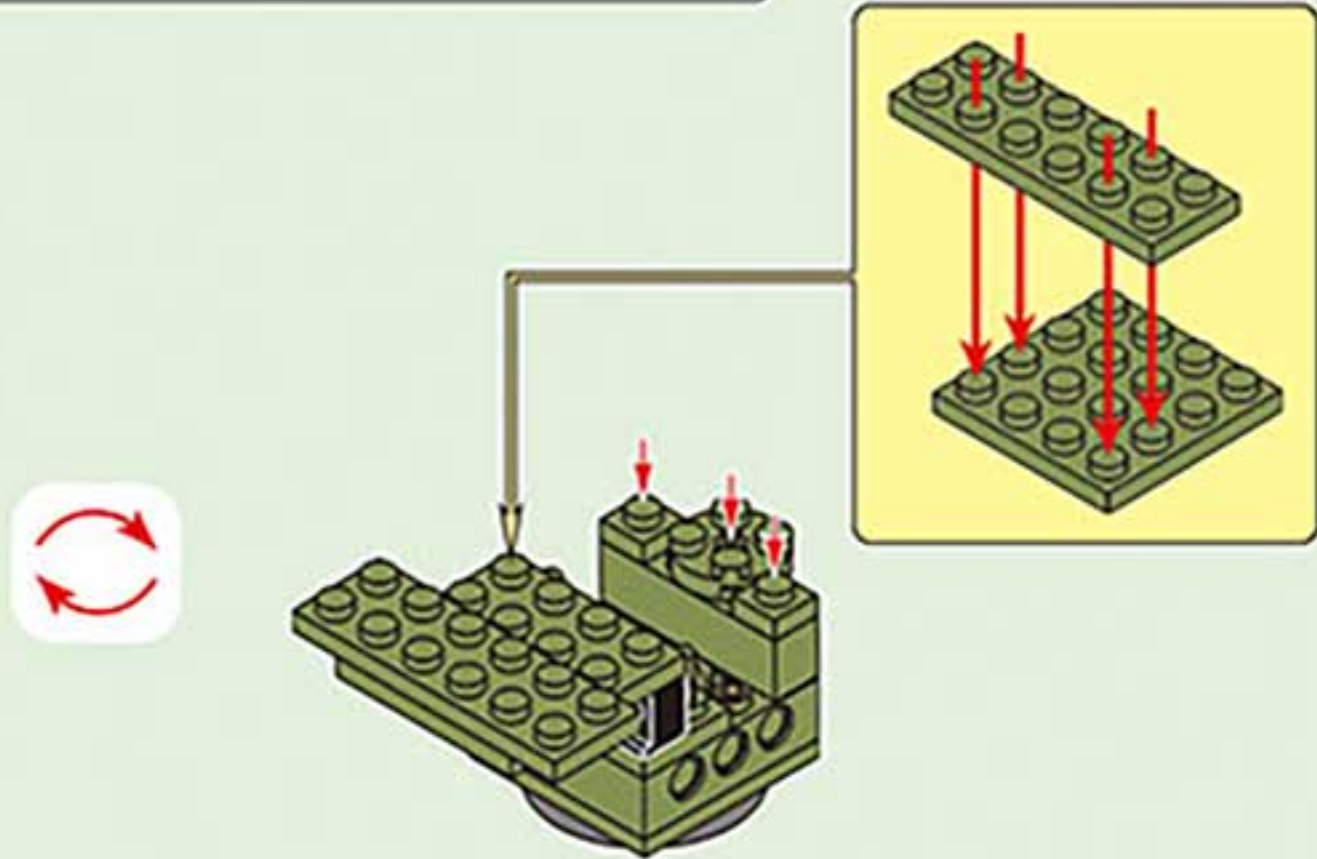

4-5

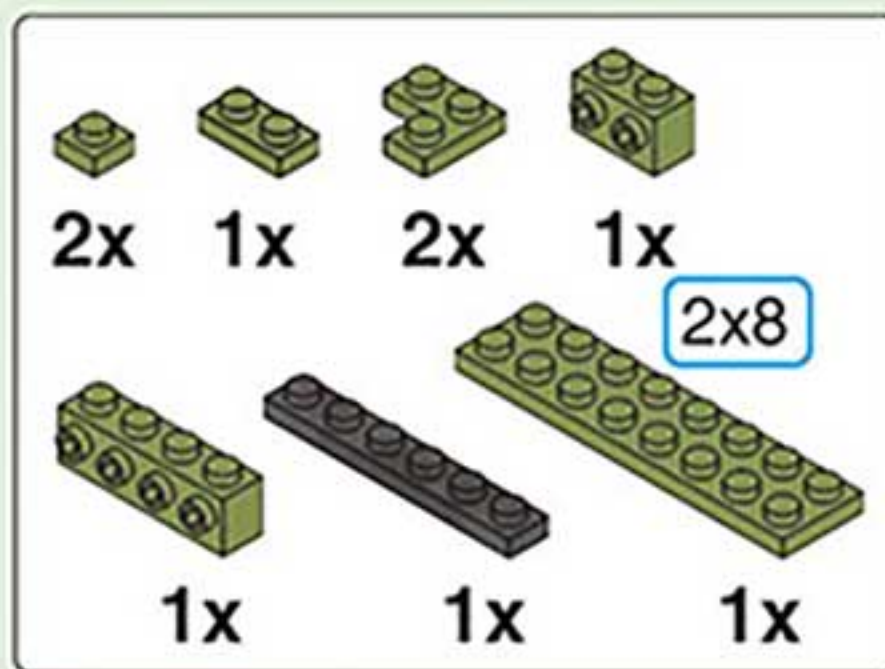
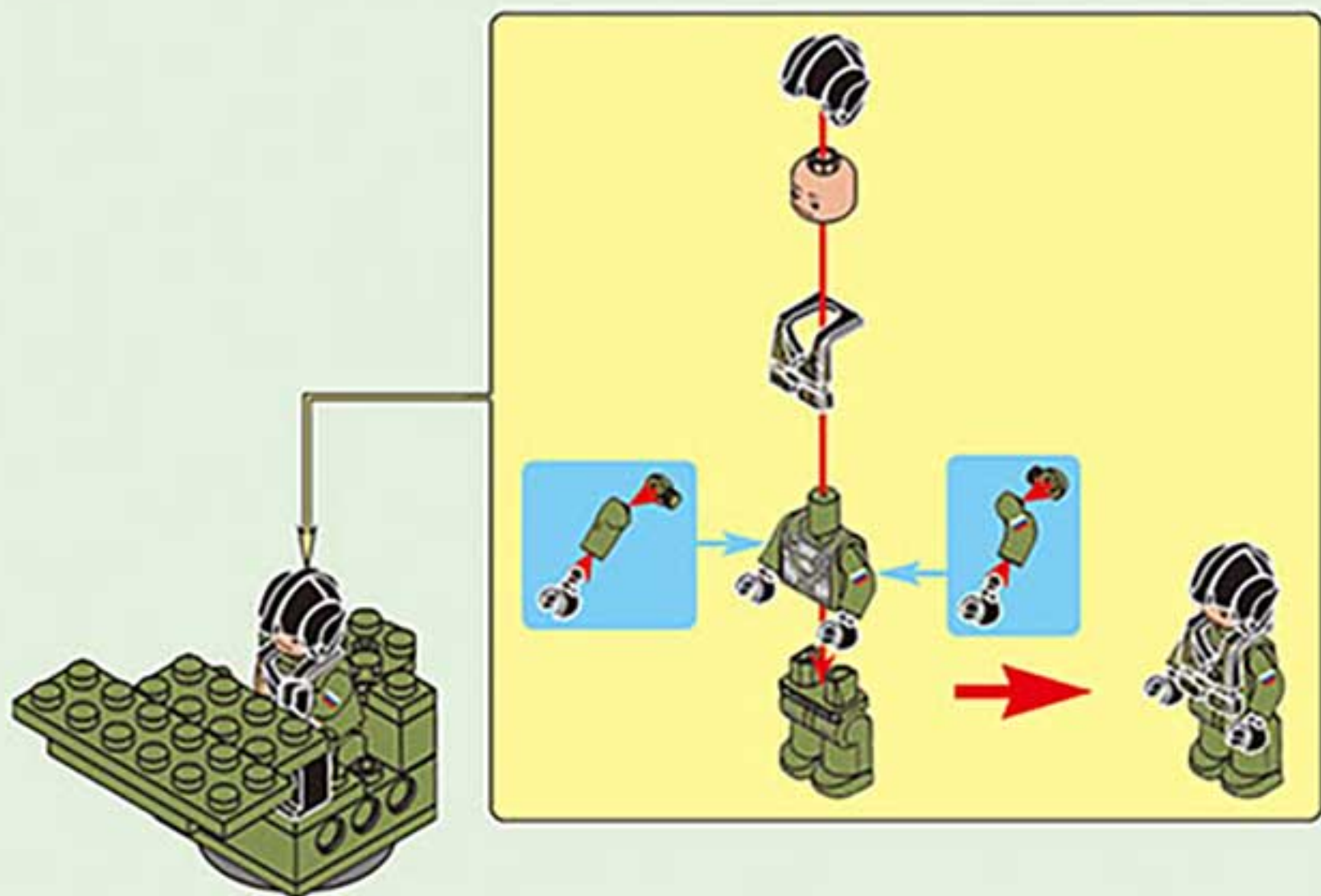

4-6

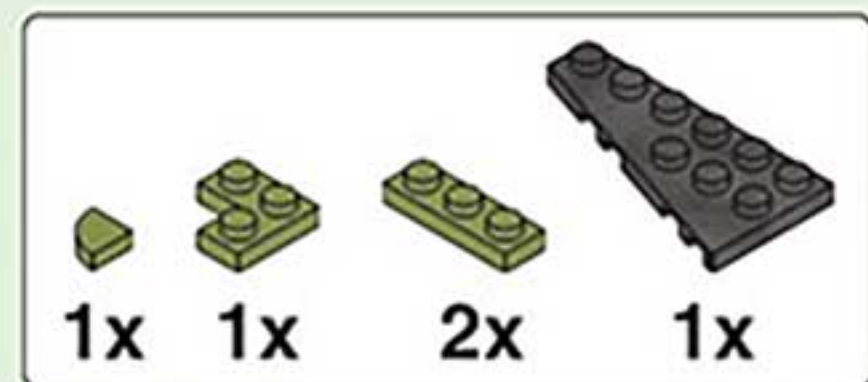
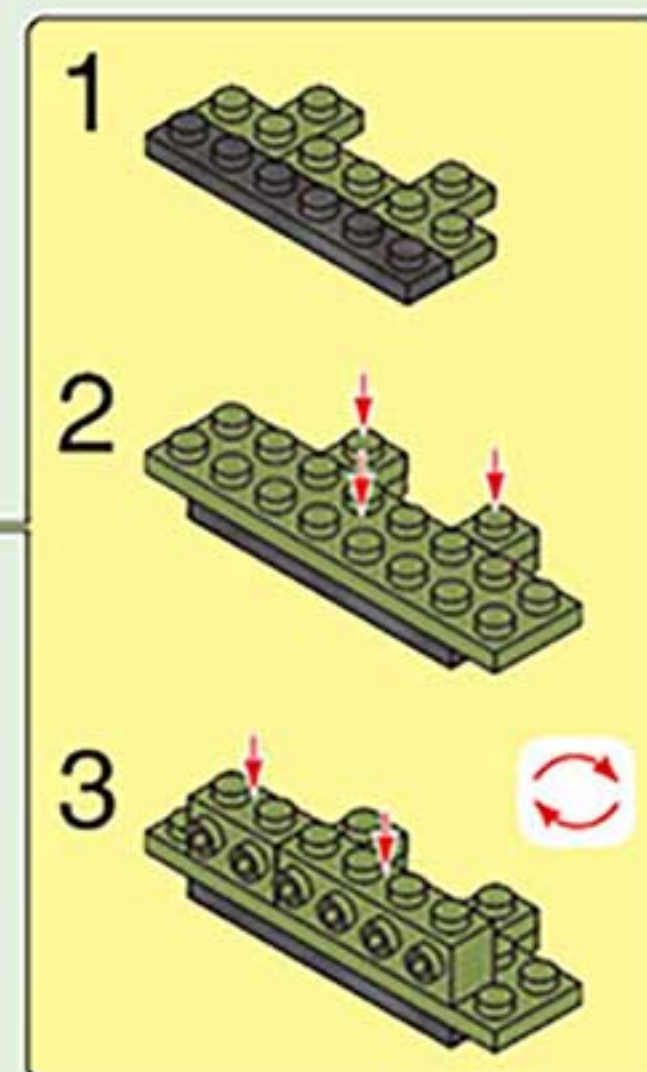
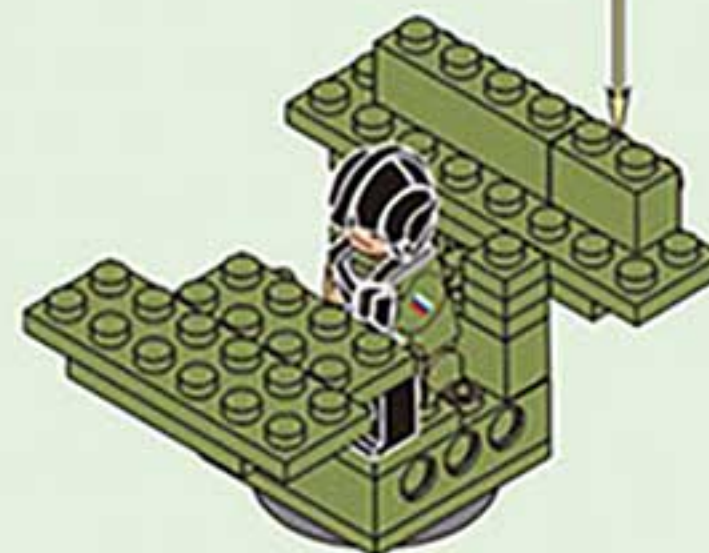

4-7

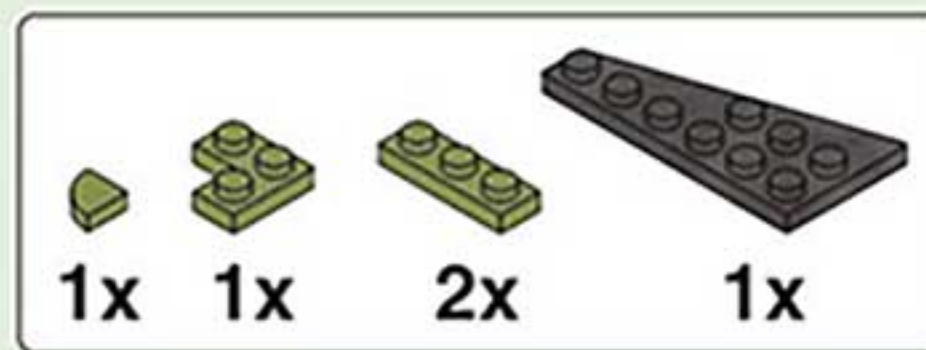
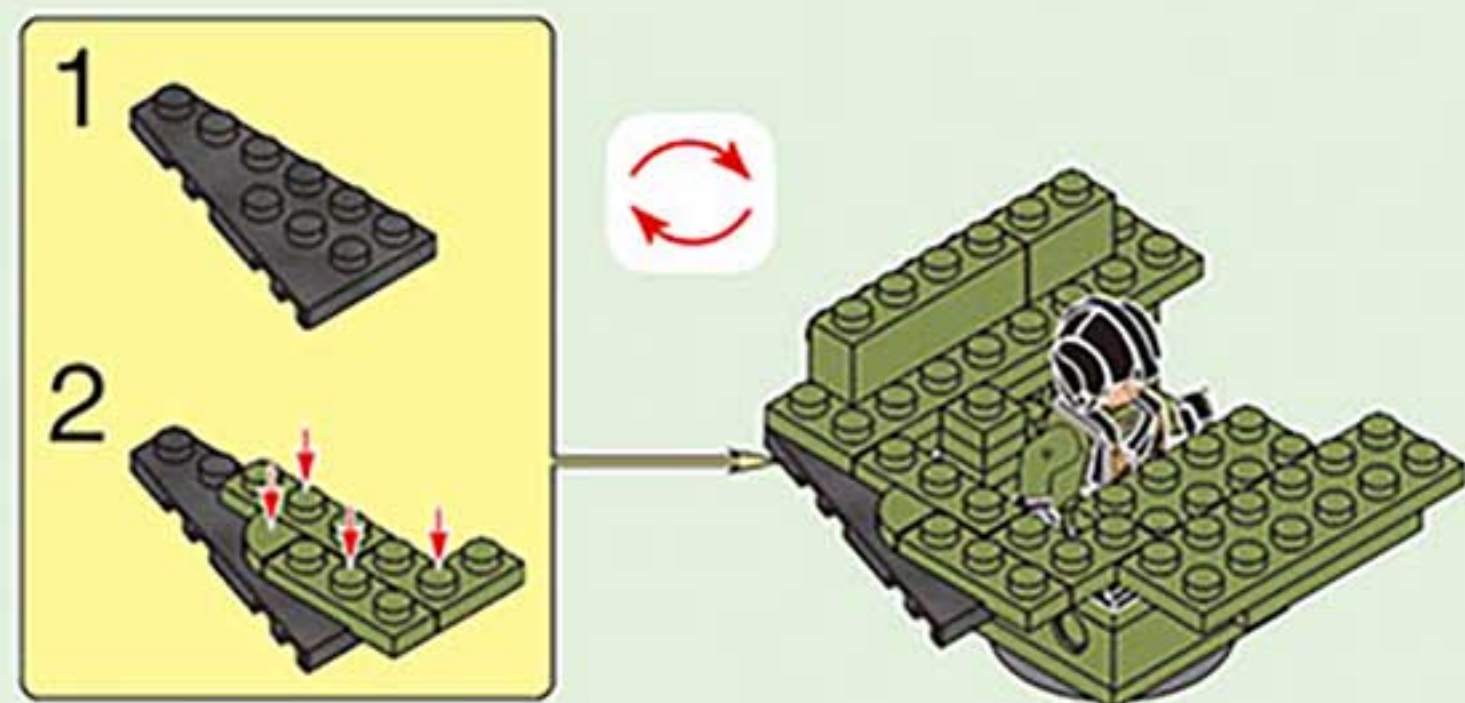

4-8

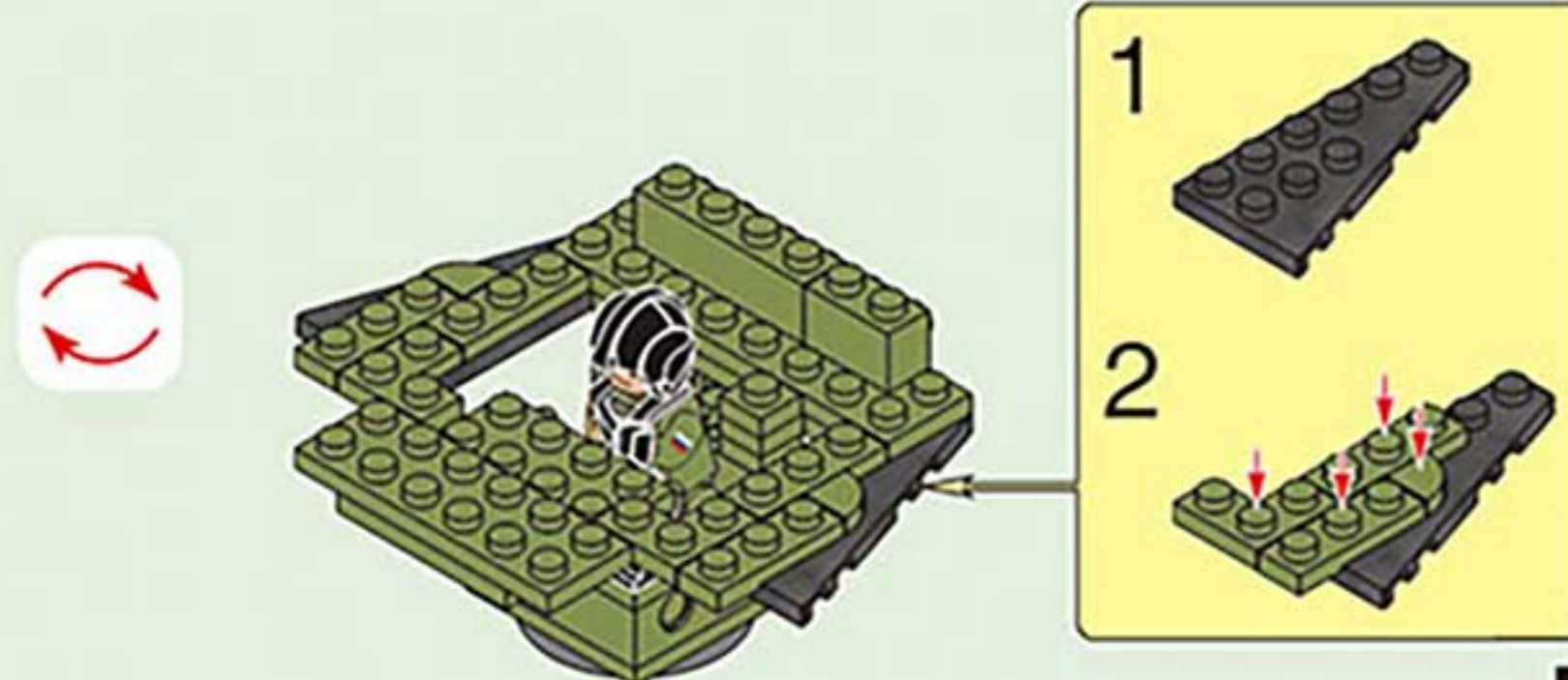

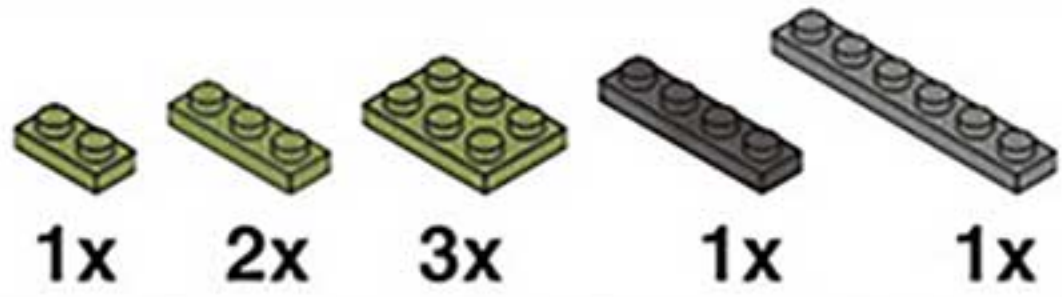

4-9

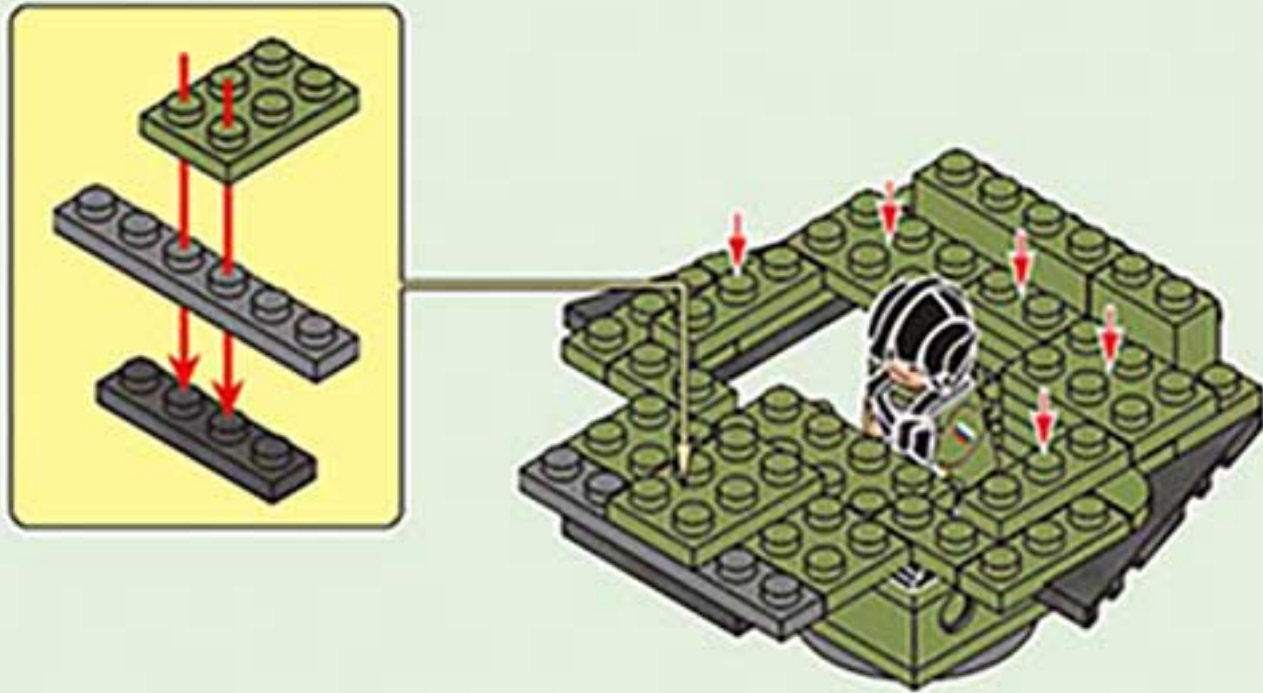

4-10

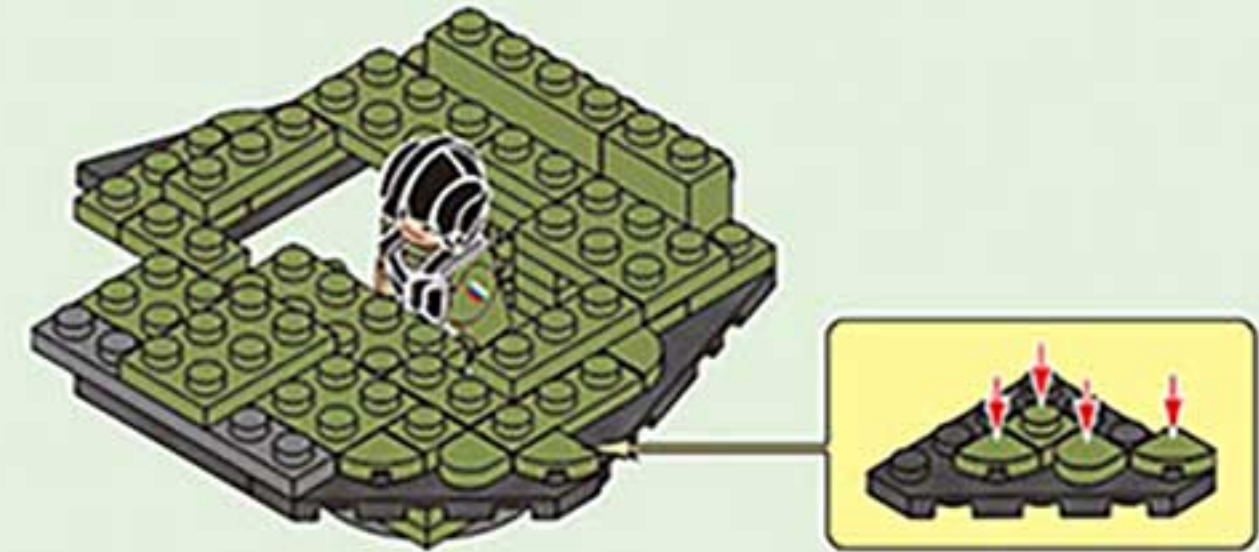

4-11

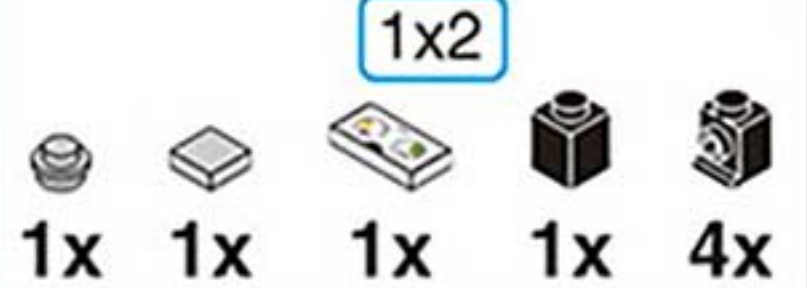
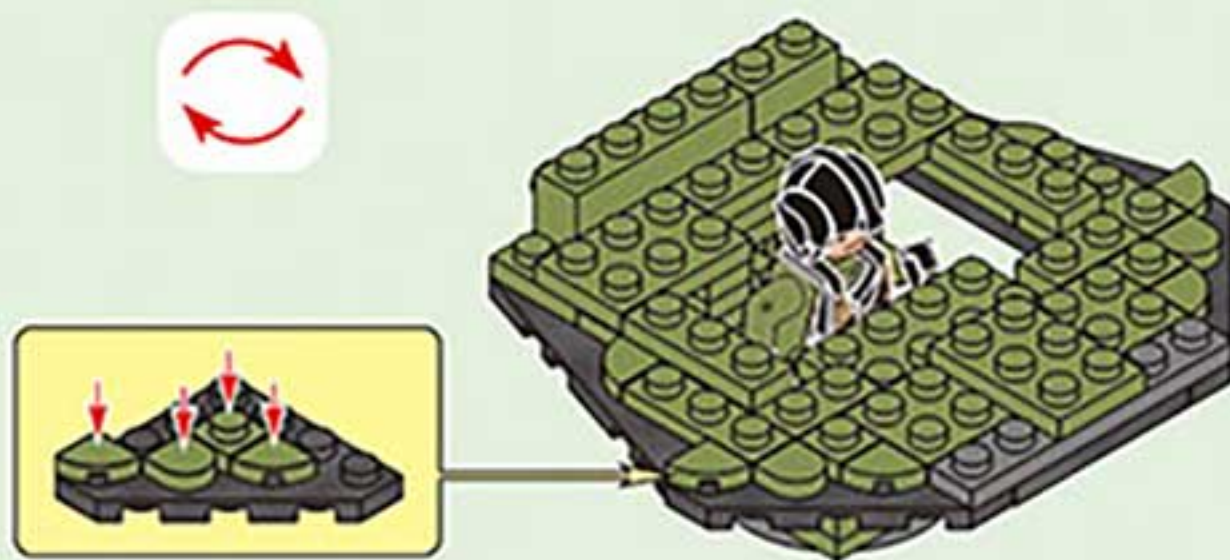

4-12

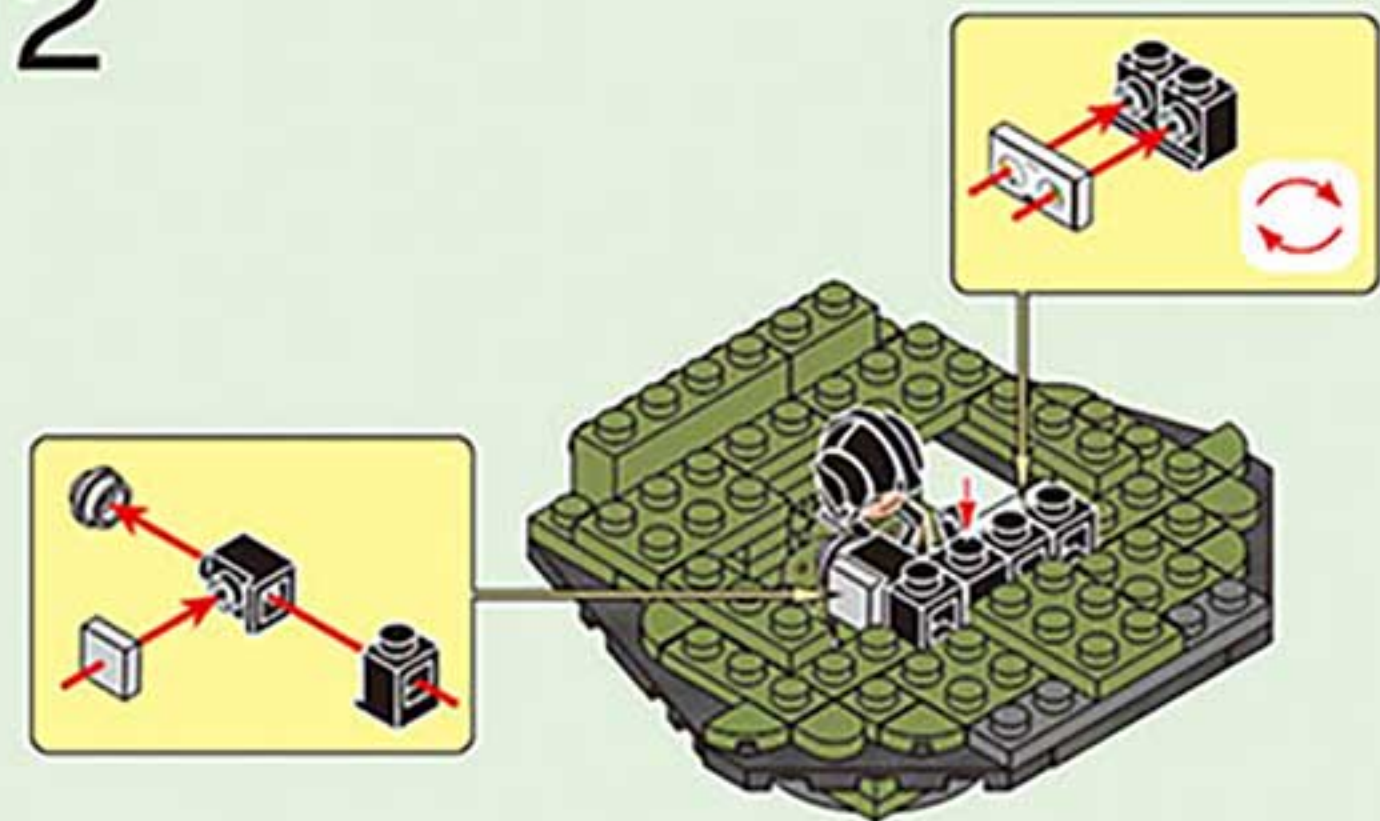

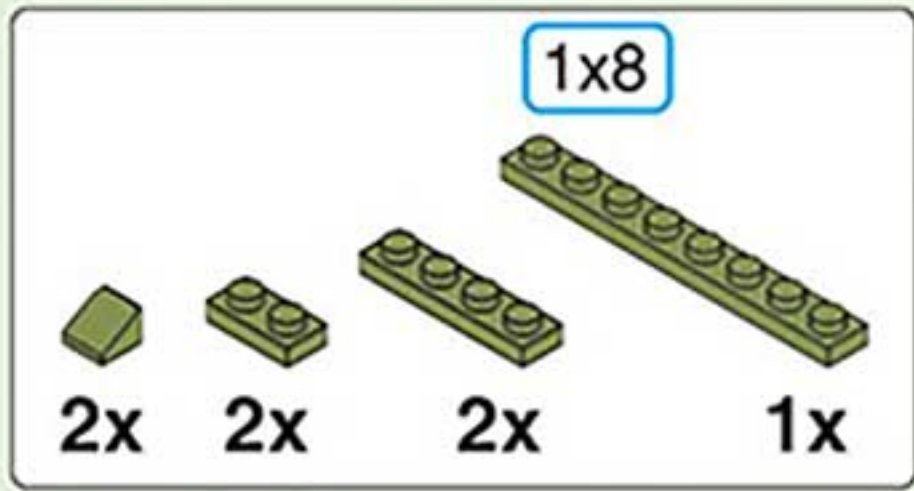

4-13

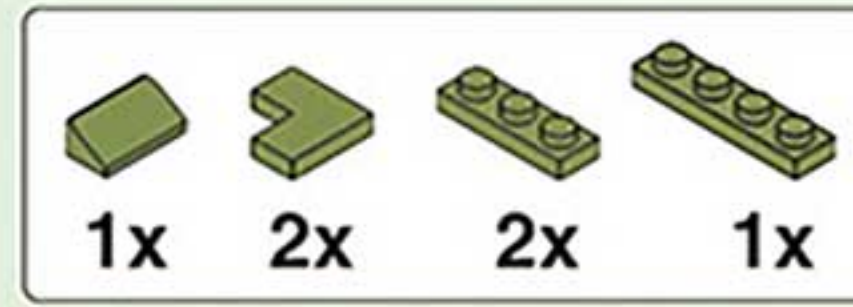
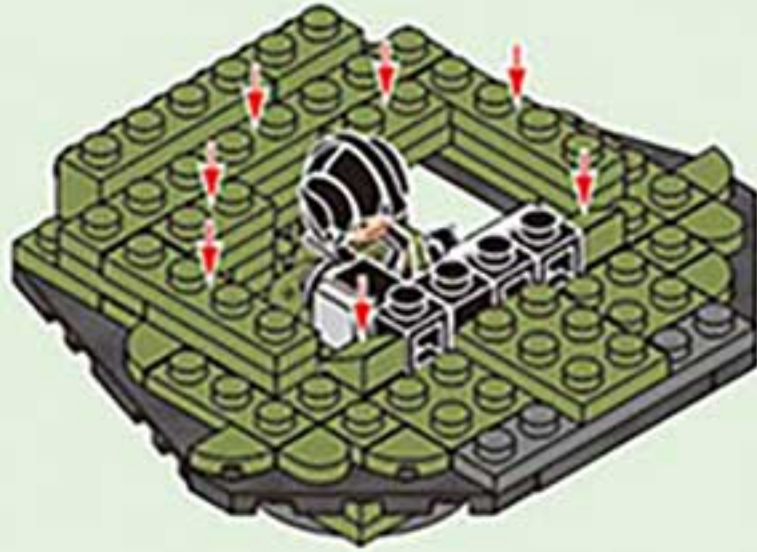

4-14

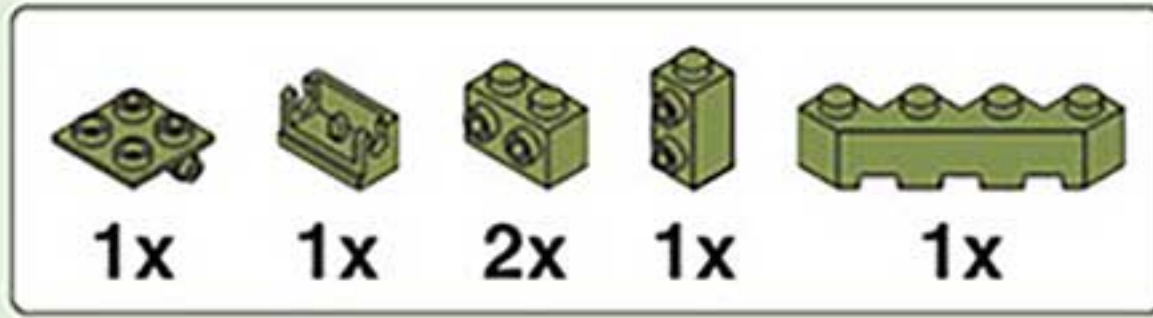
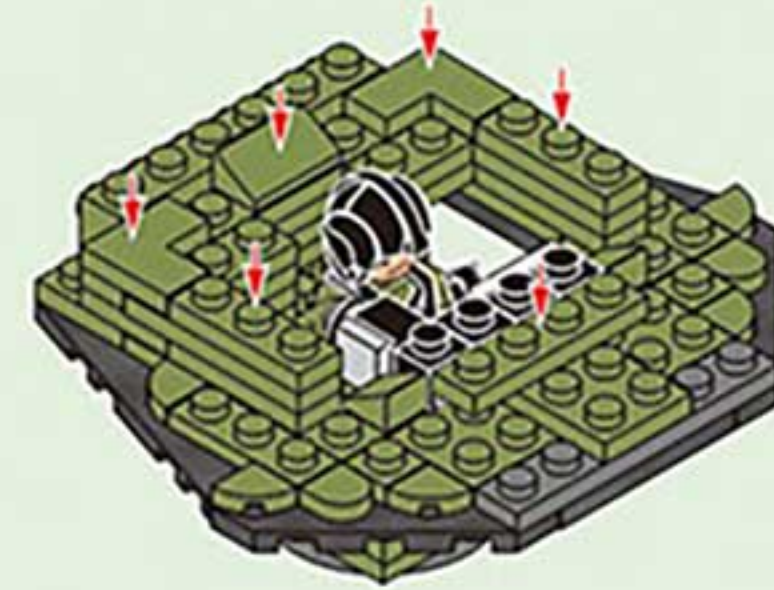

4-15

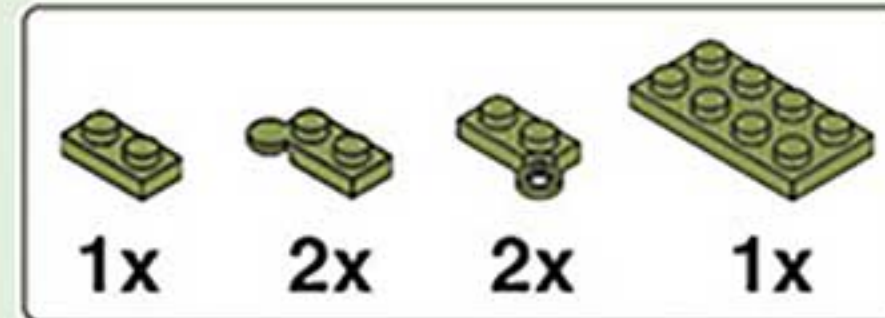
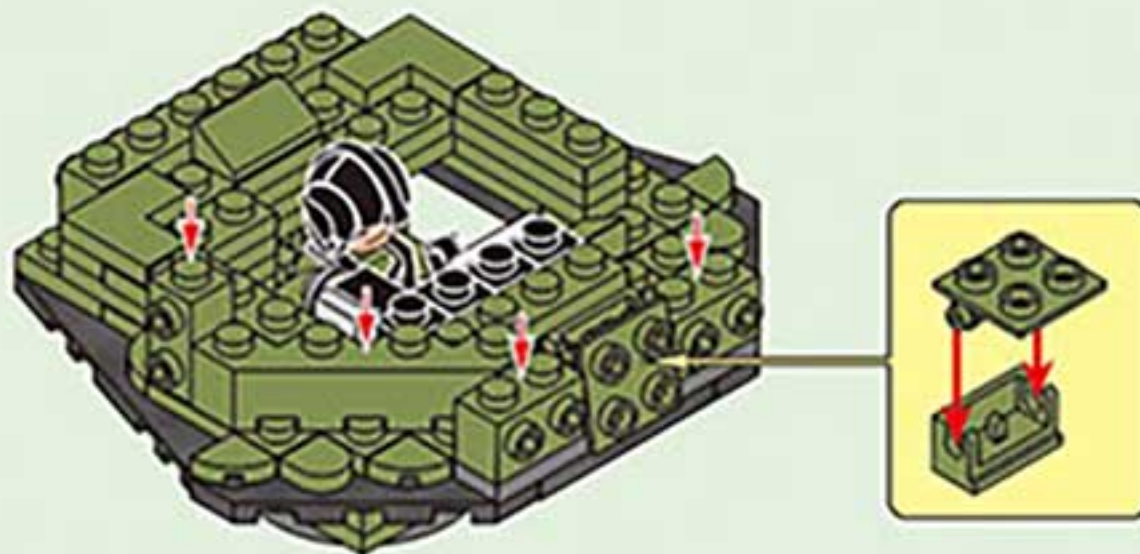

4-16

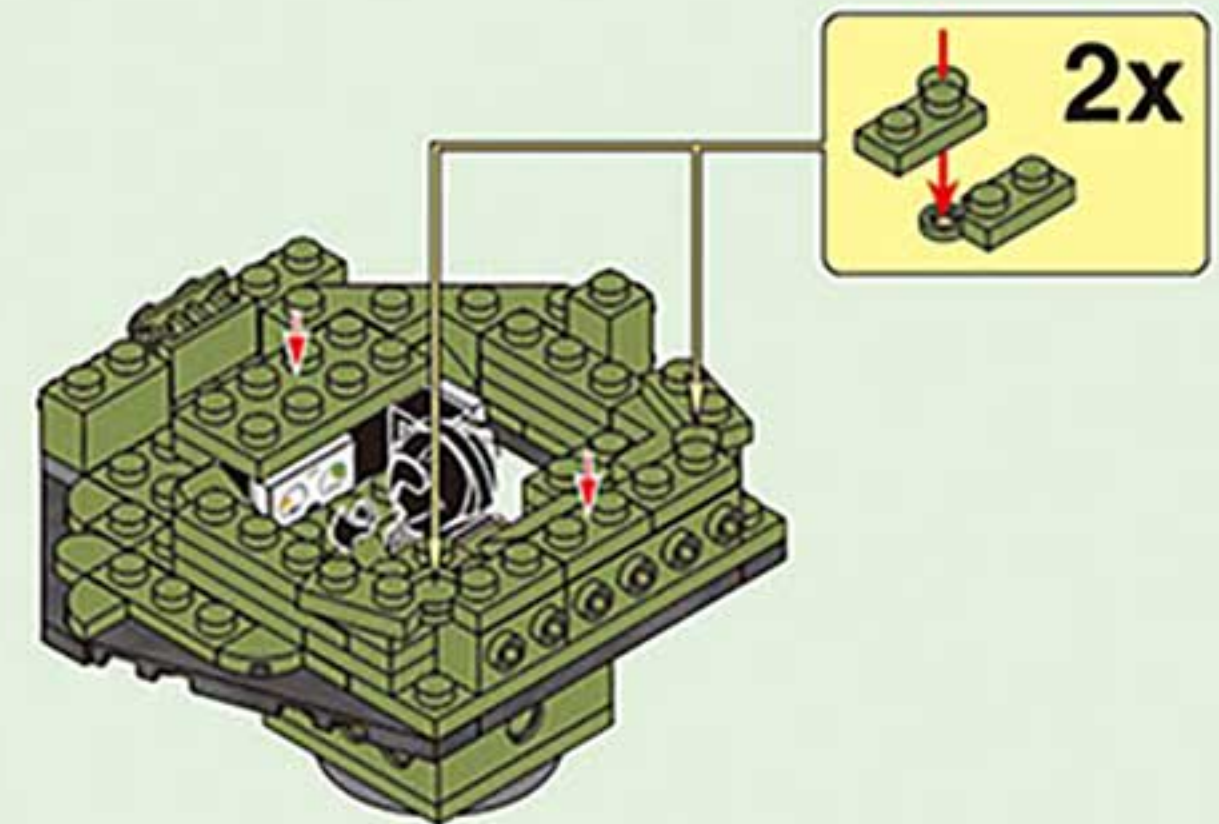

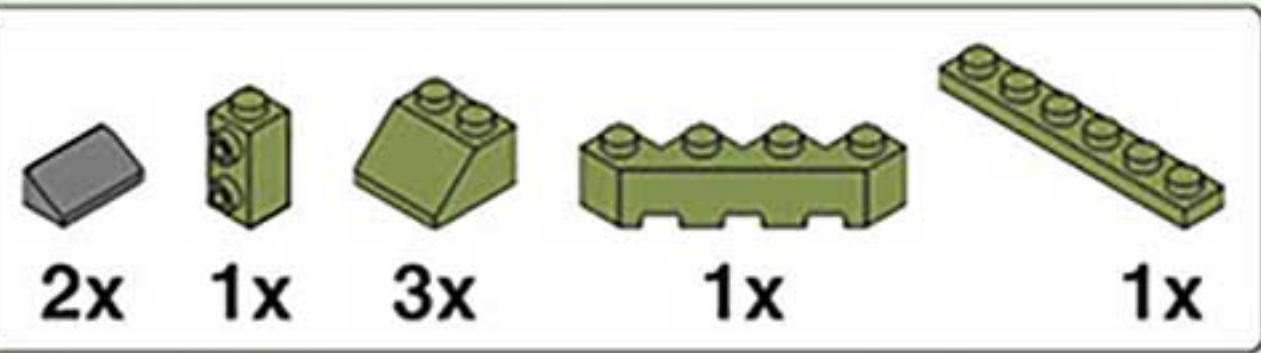

4-17

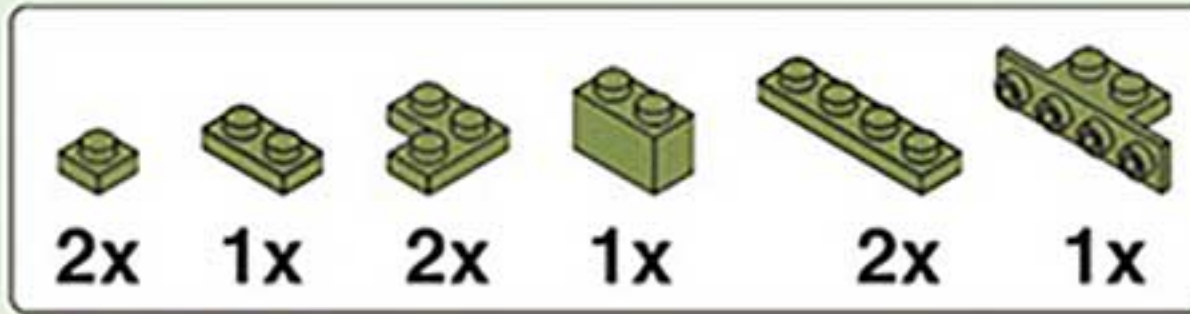
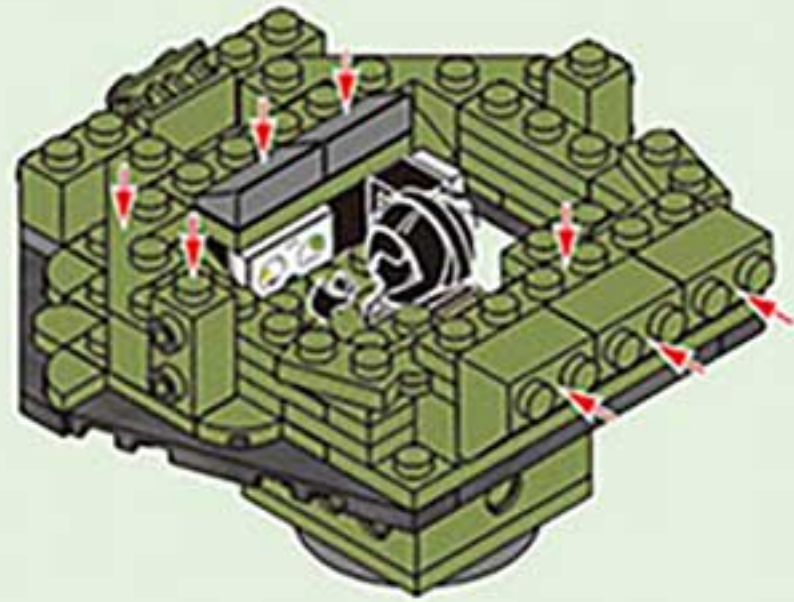

4-18

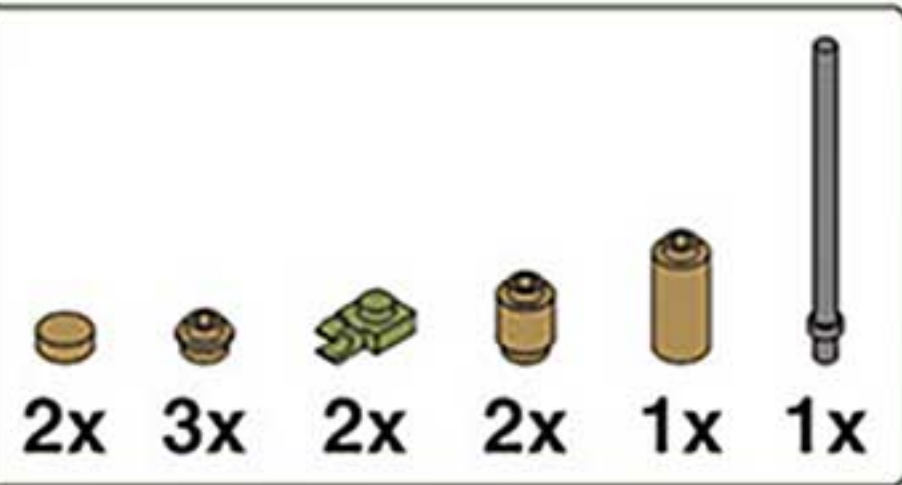
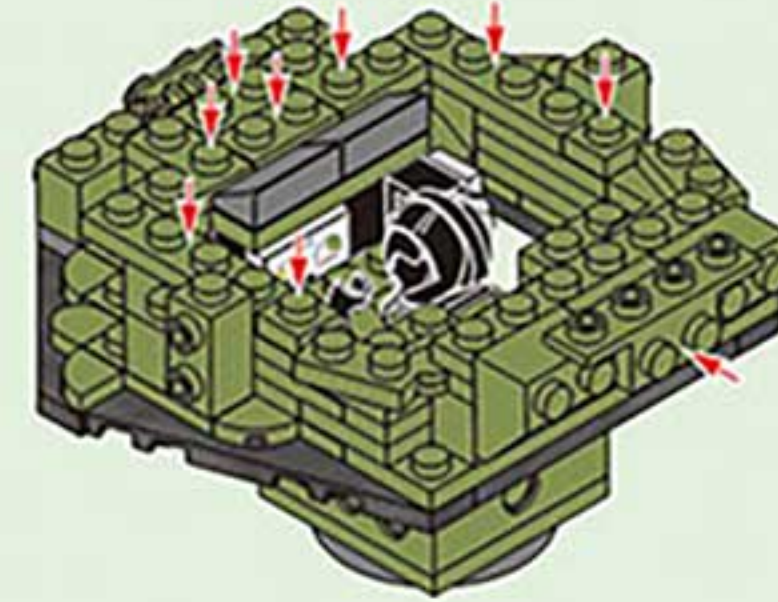

4-19

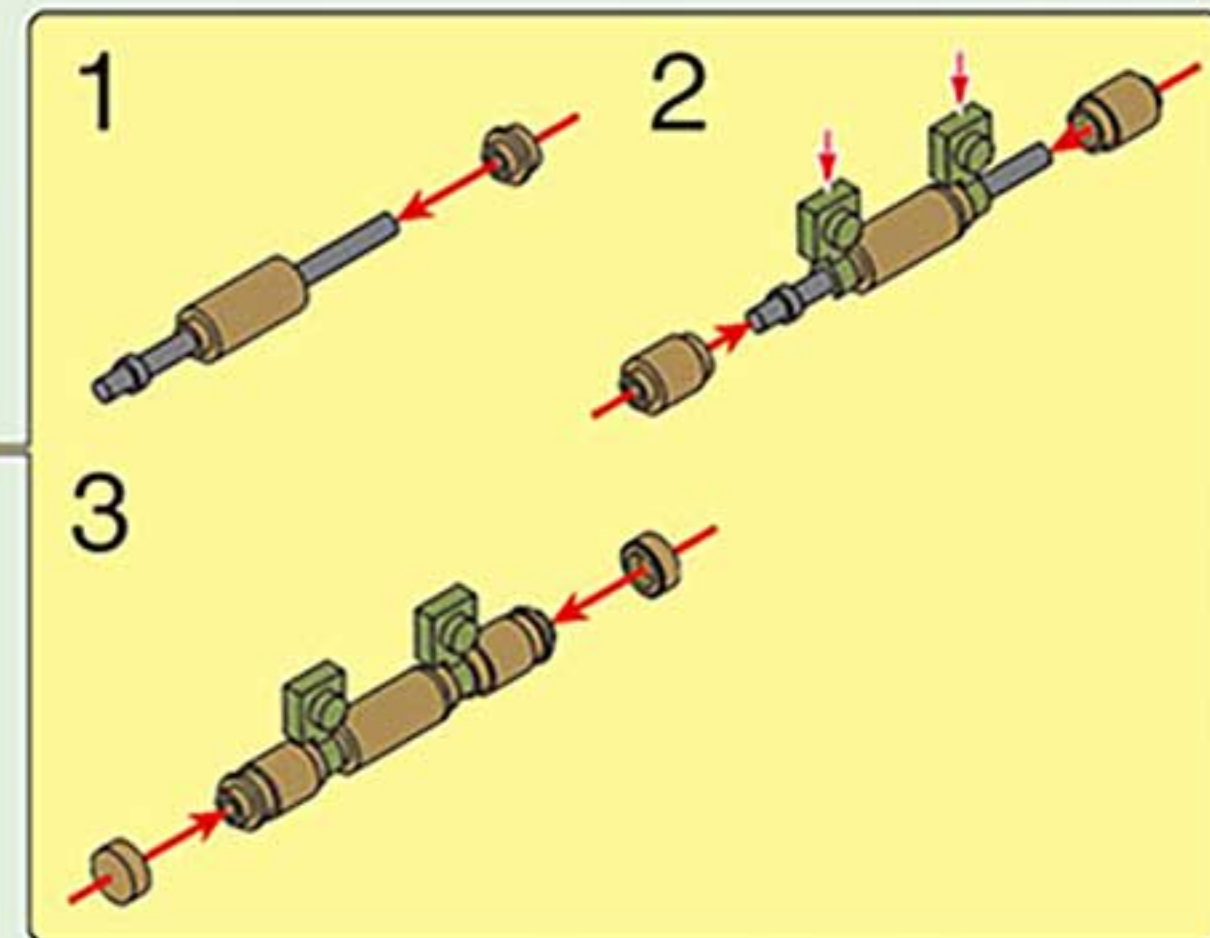
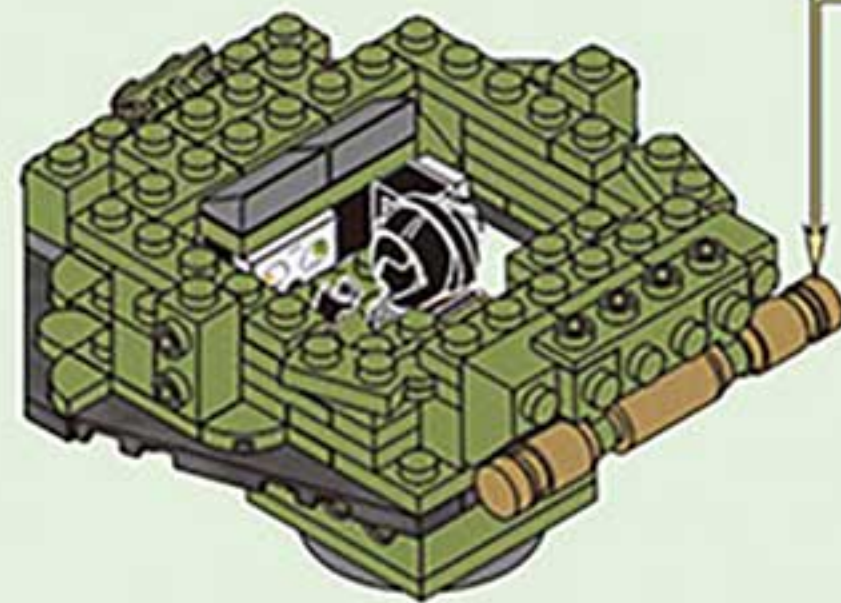

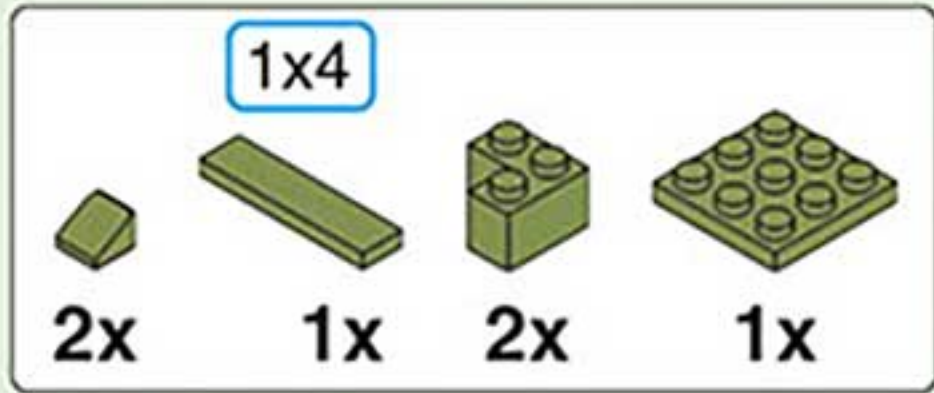

4-20

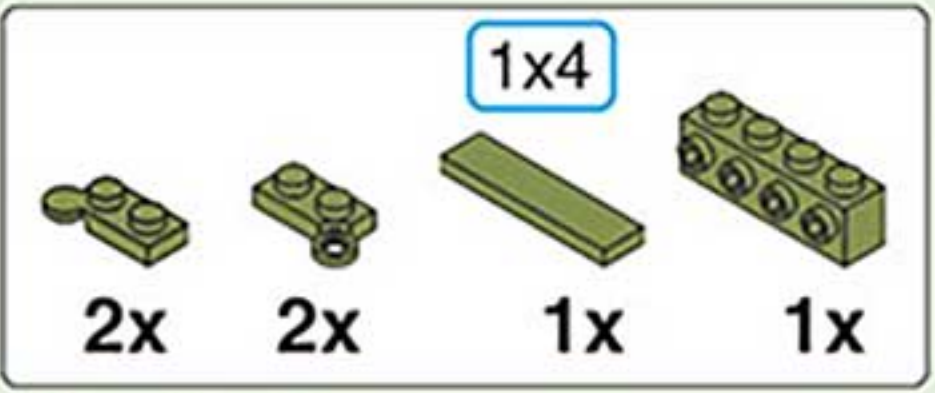
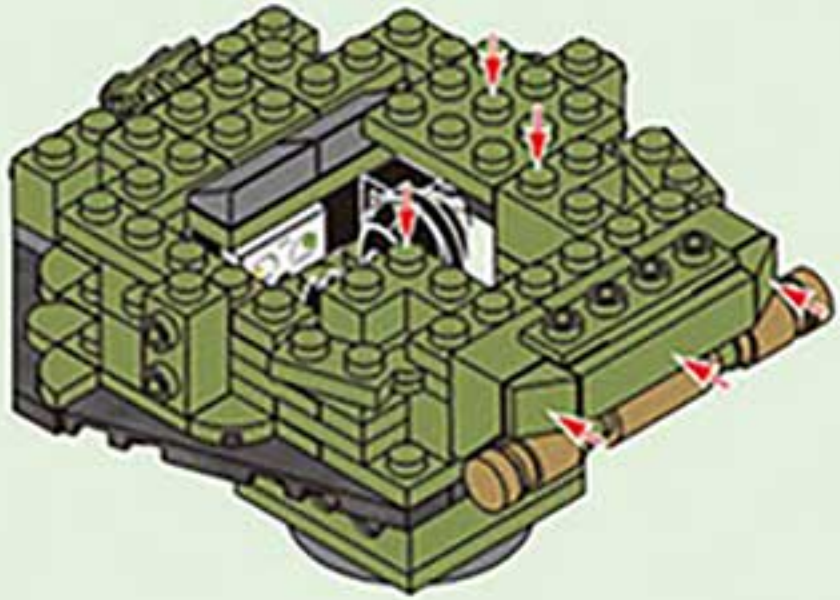

4-21

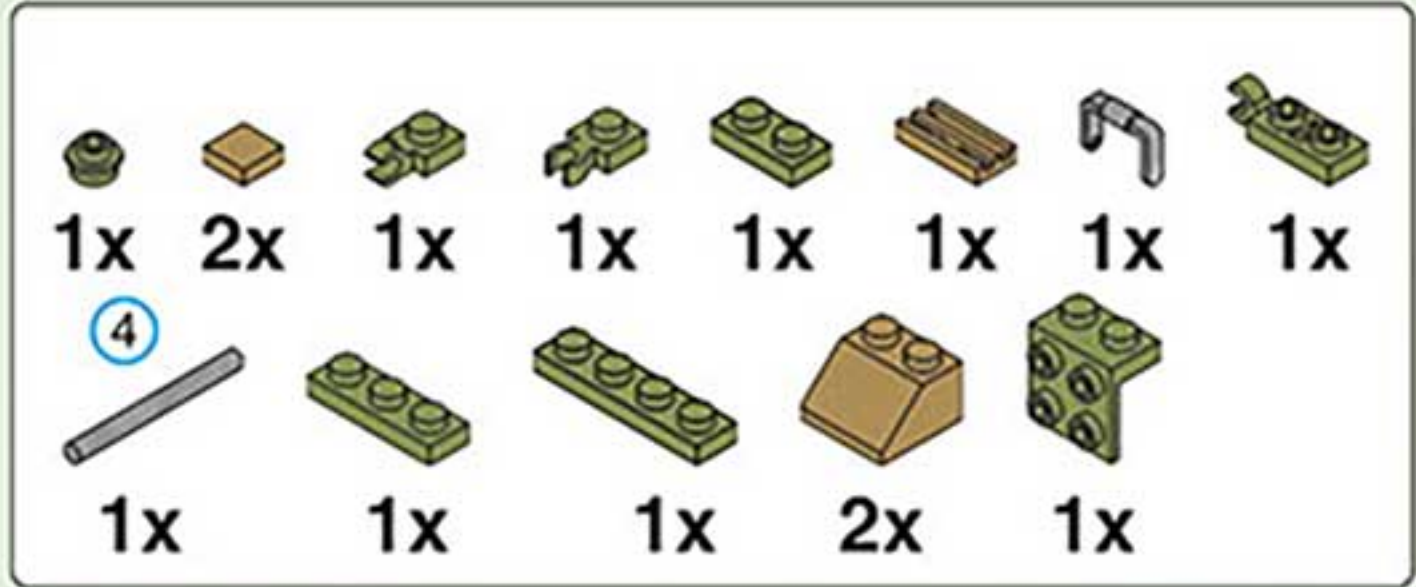
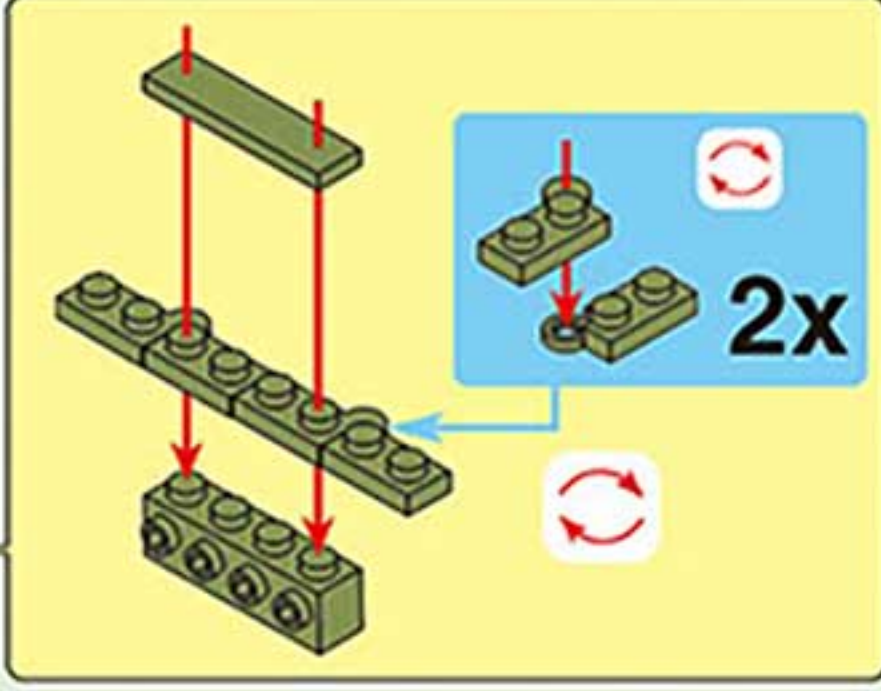

4-22

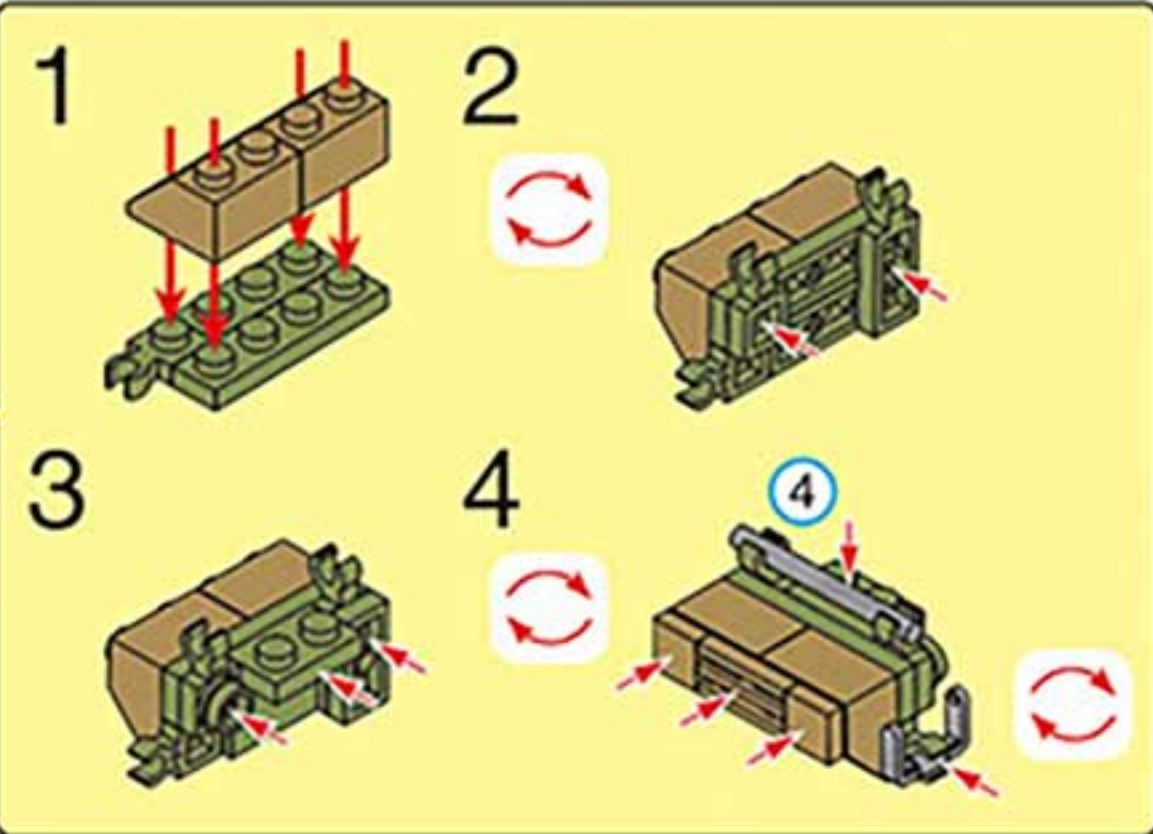
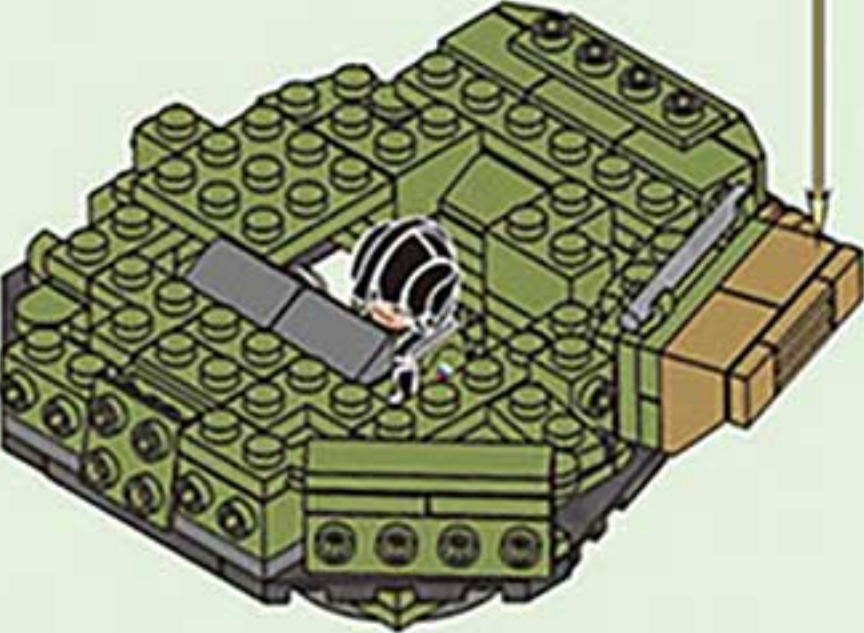

1x2

1x 3x 1x

# 4-23

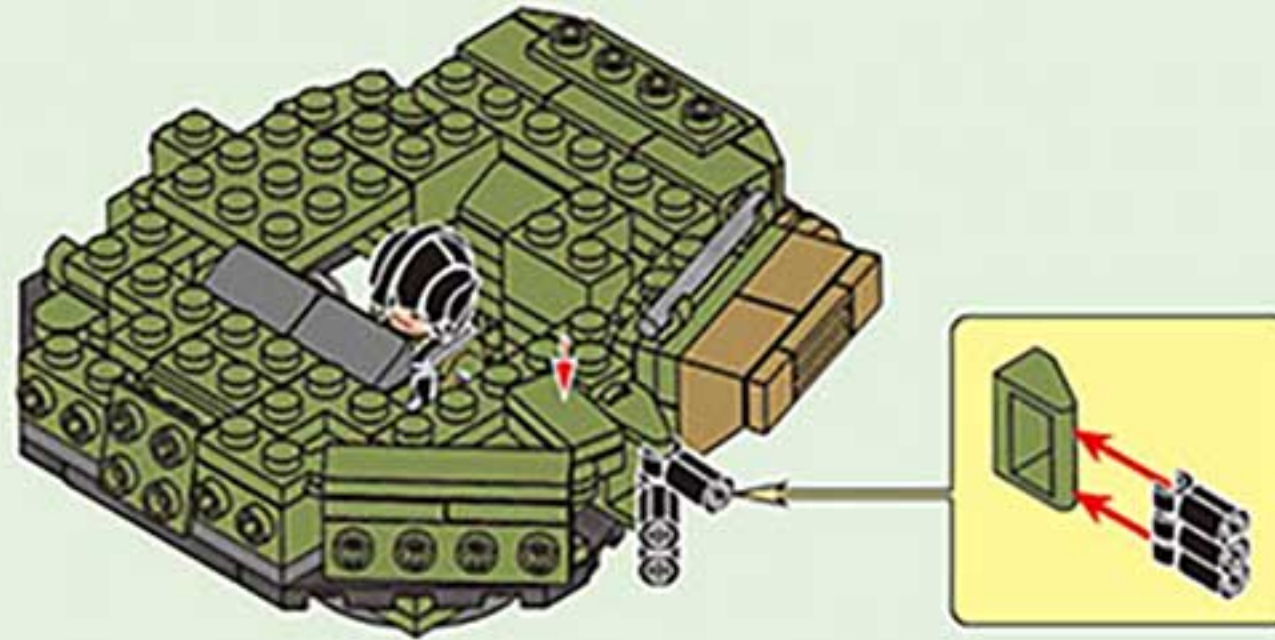

4x 1x 1x 1x 1x 1x 2x

1x 1x 1x 1x

# 4-24

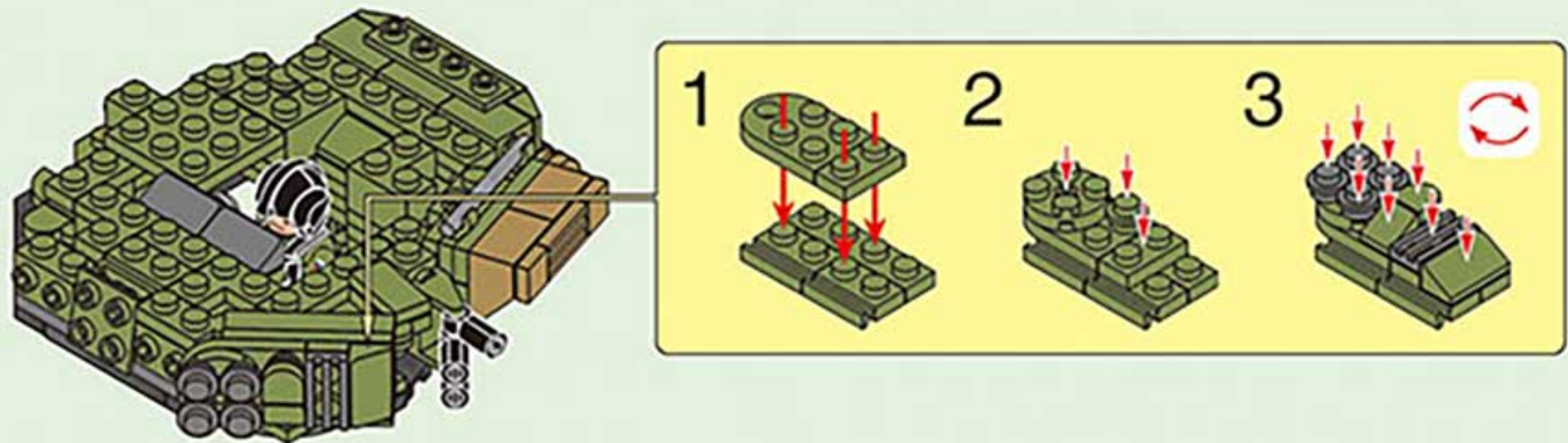

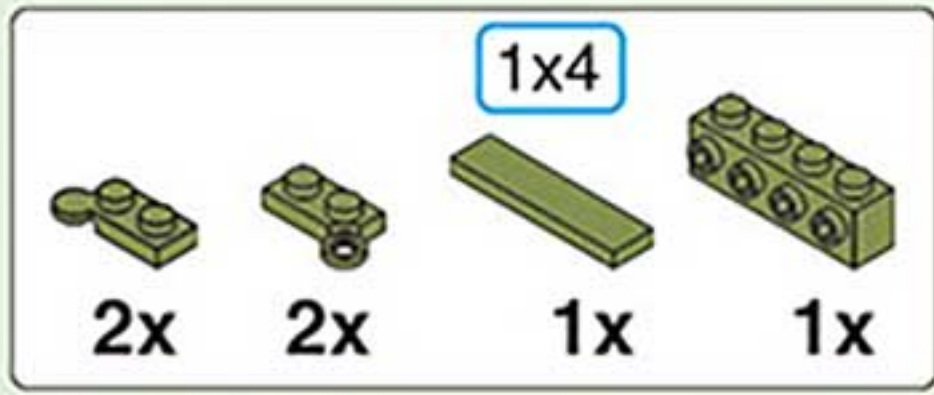

# 4-25

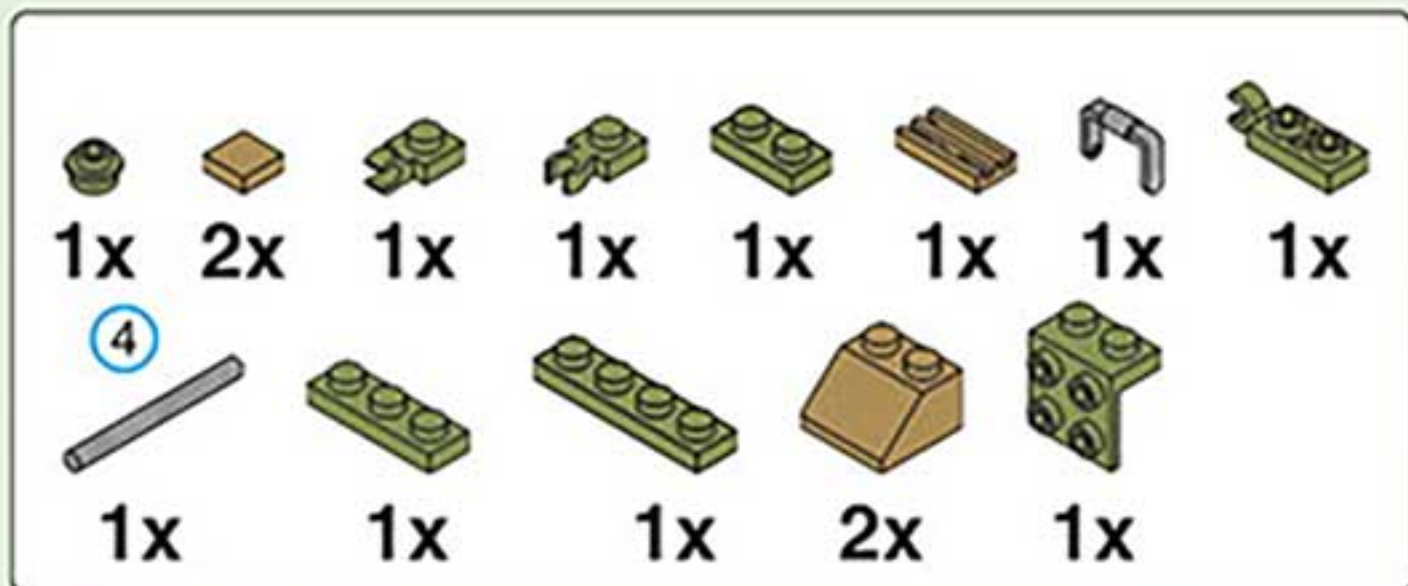
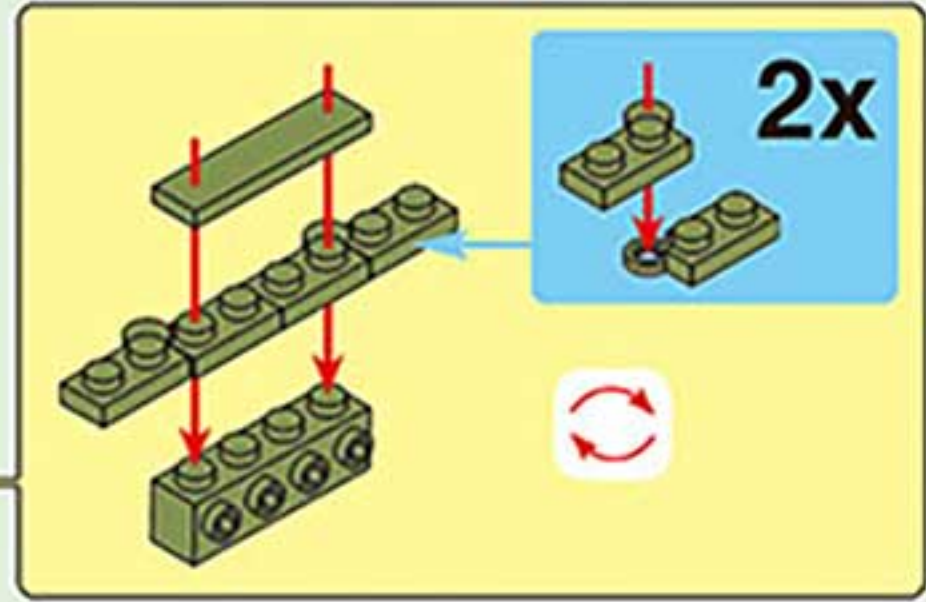
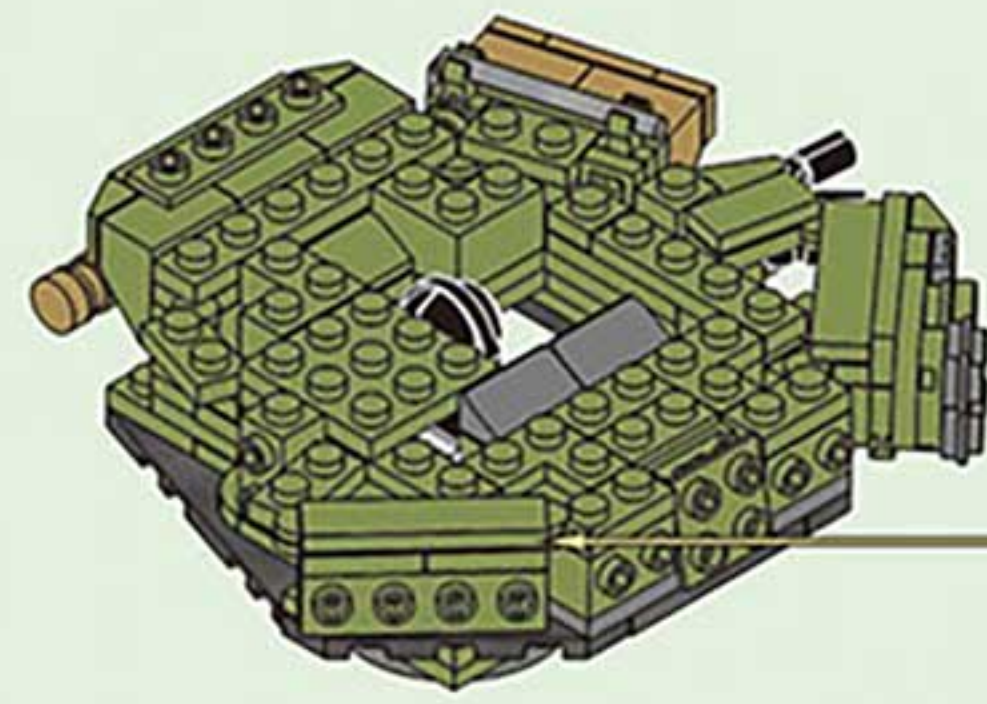

# 4-26

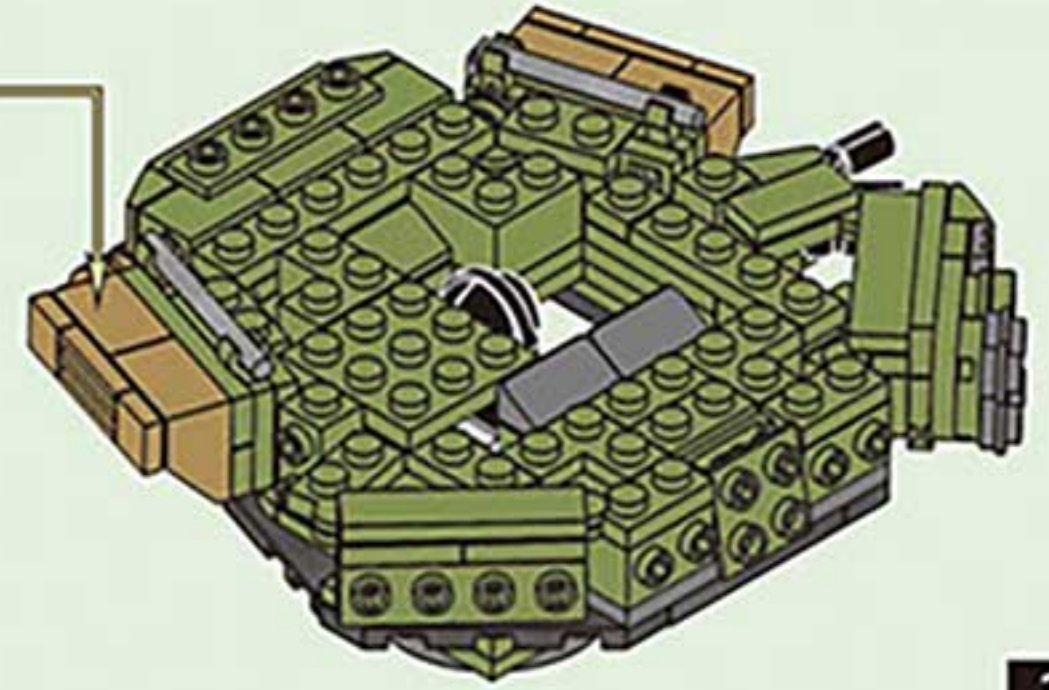
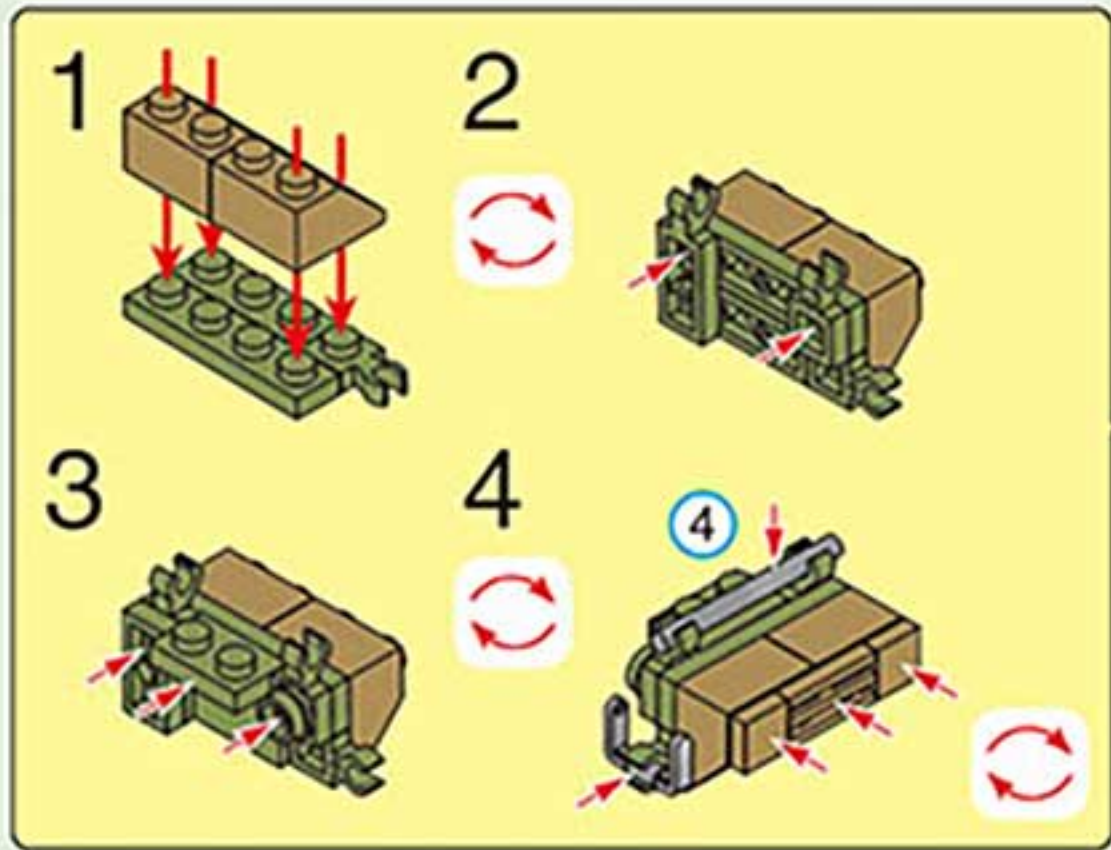

1x2

1x 3x 1x

4-27

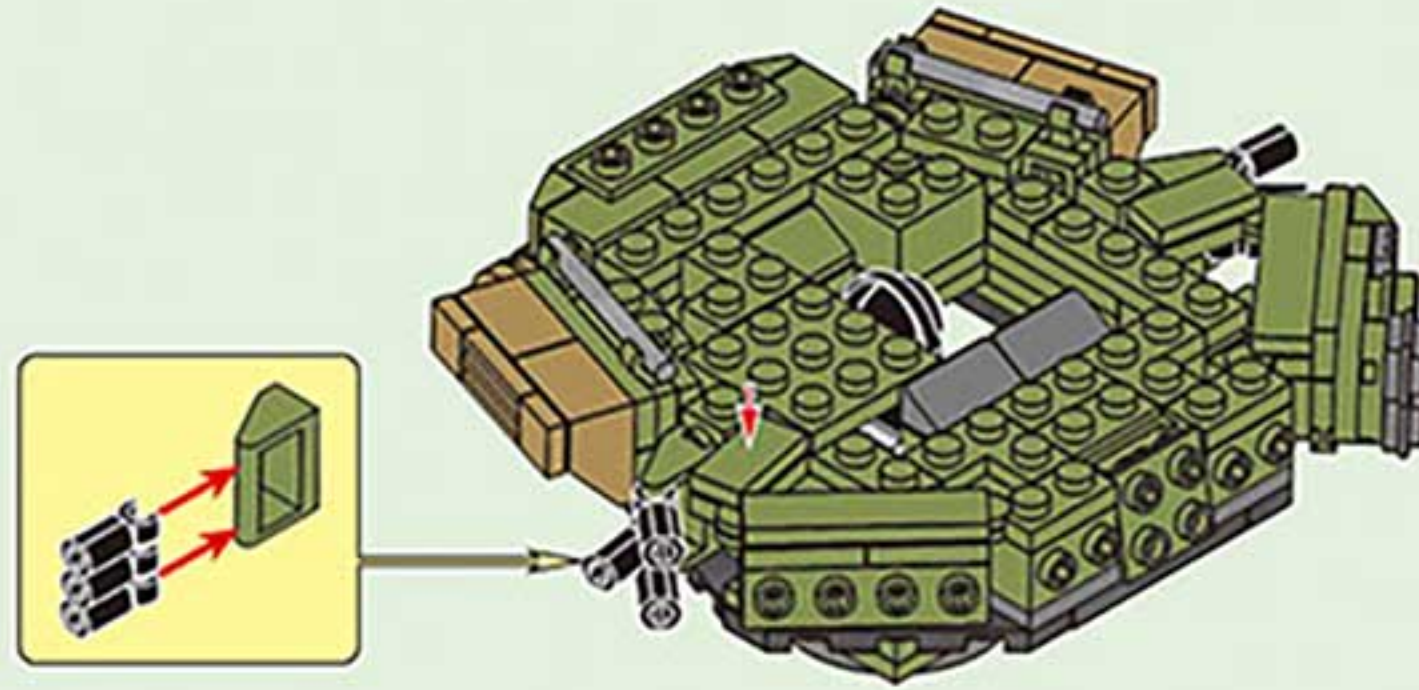

4x 1x 1x 1x 1x 1x 2x

1x 1x 1x 1x

4-28

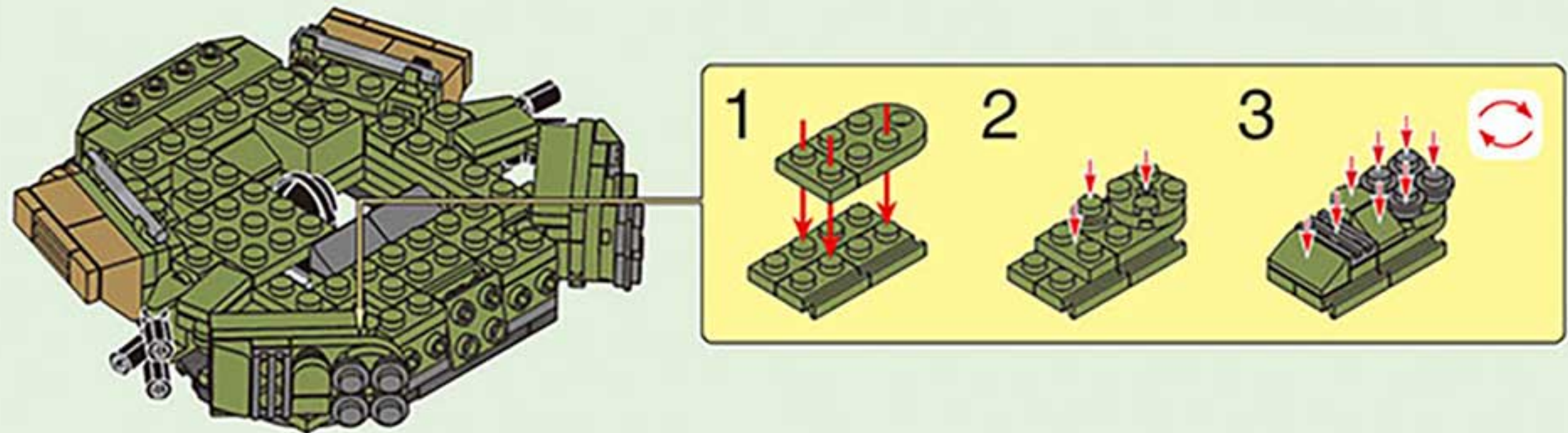



x5

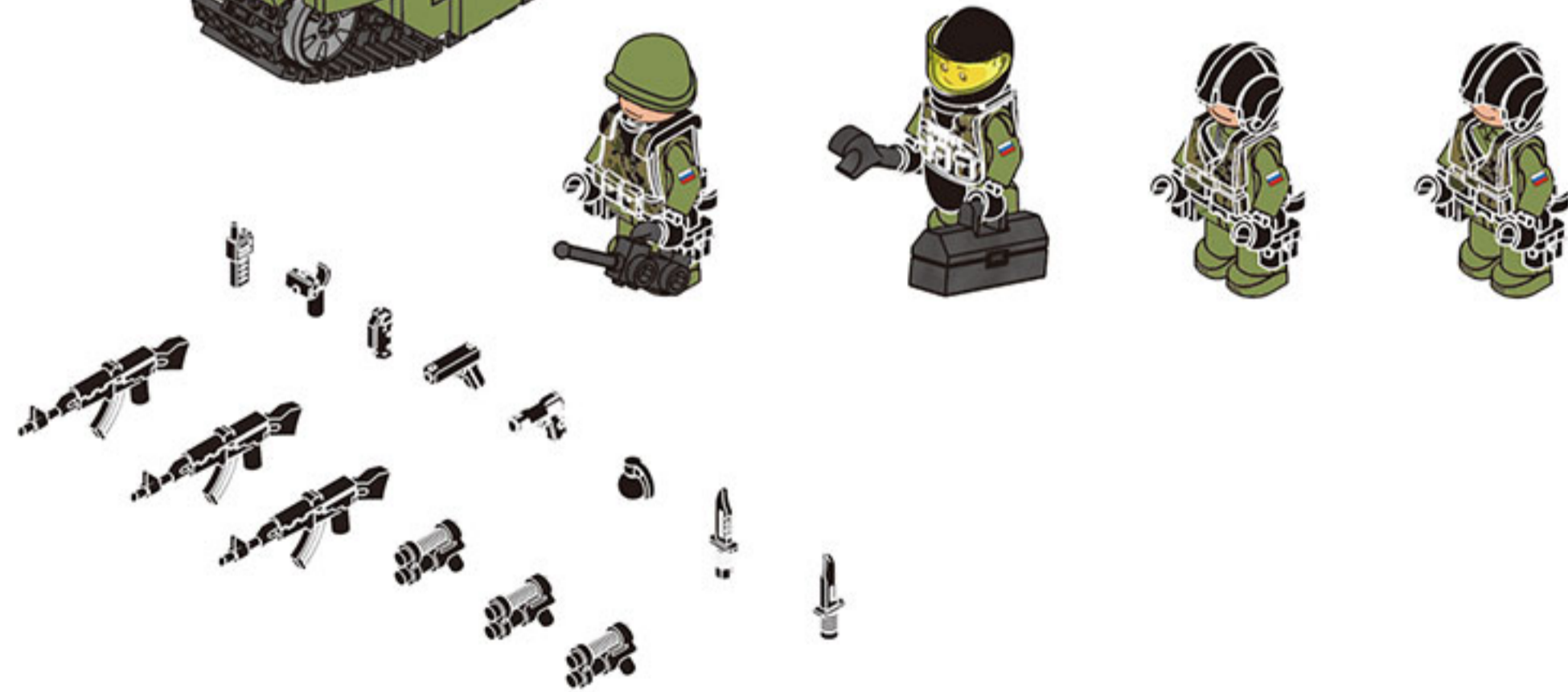
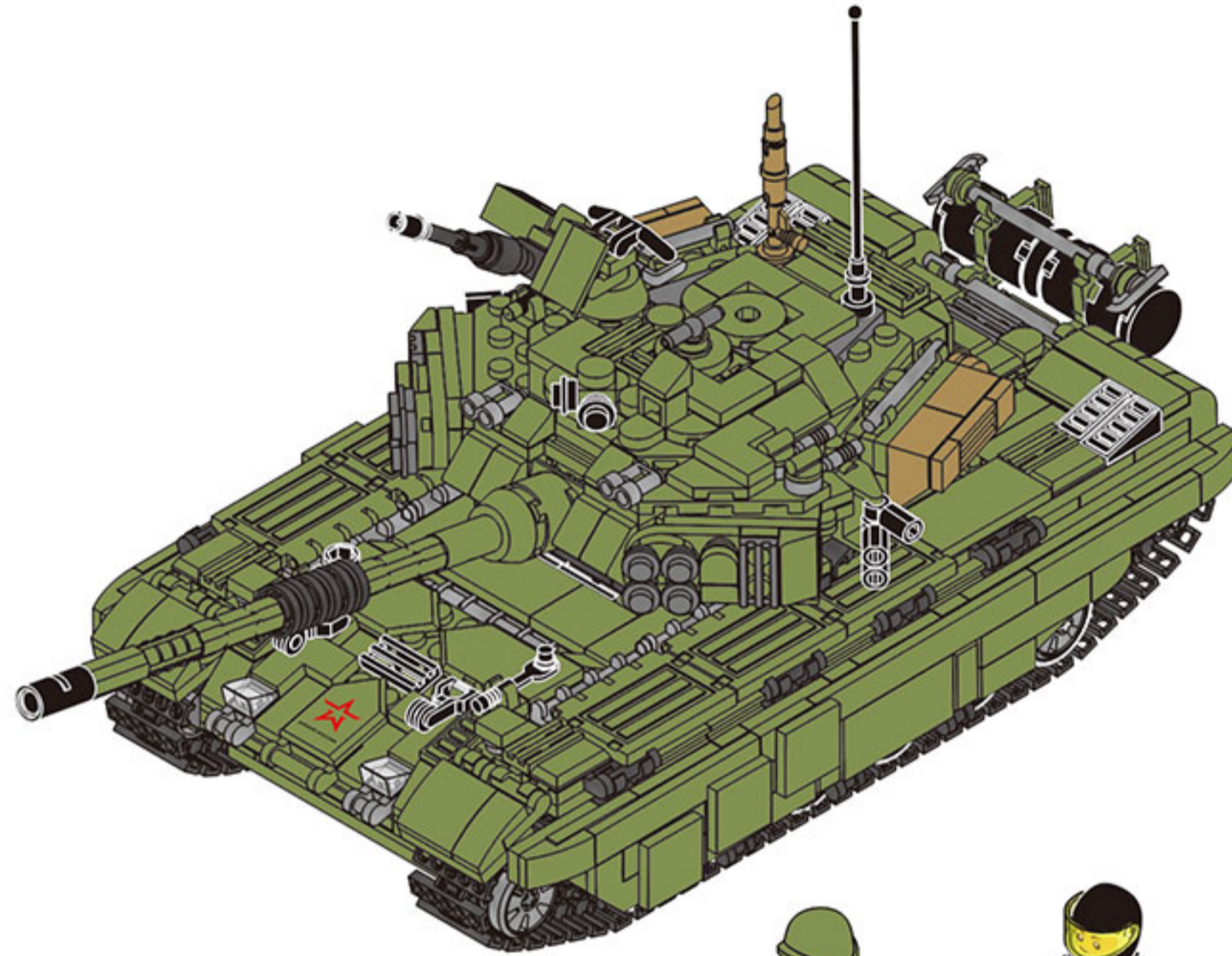

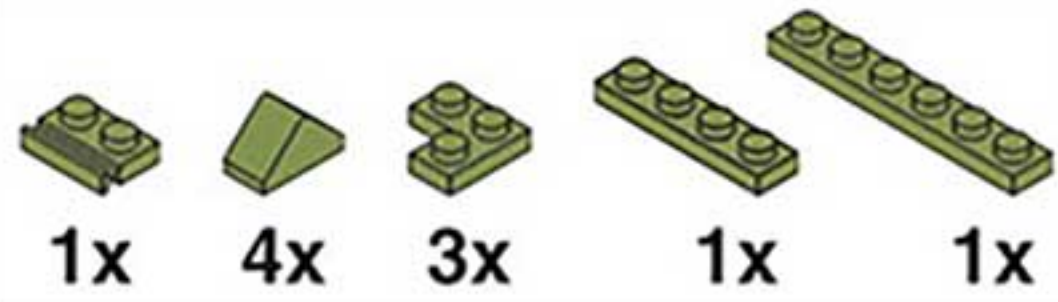

5-1

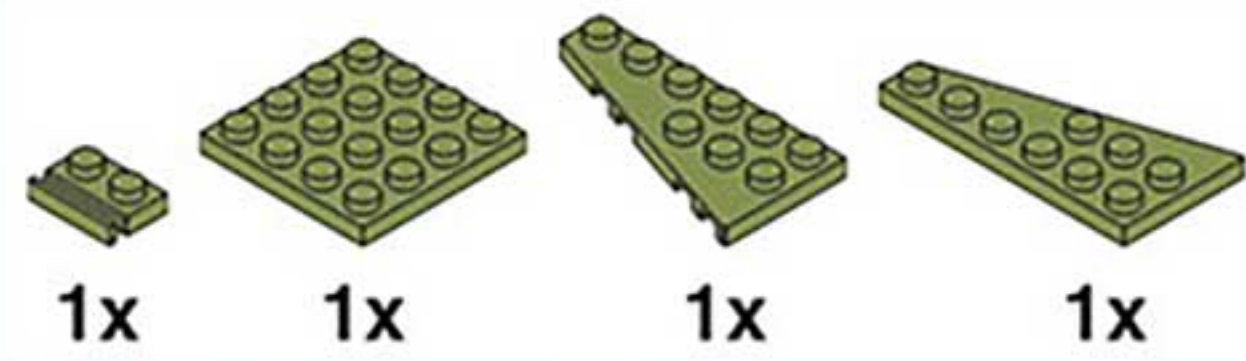
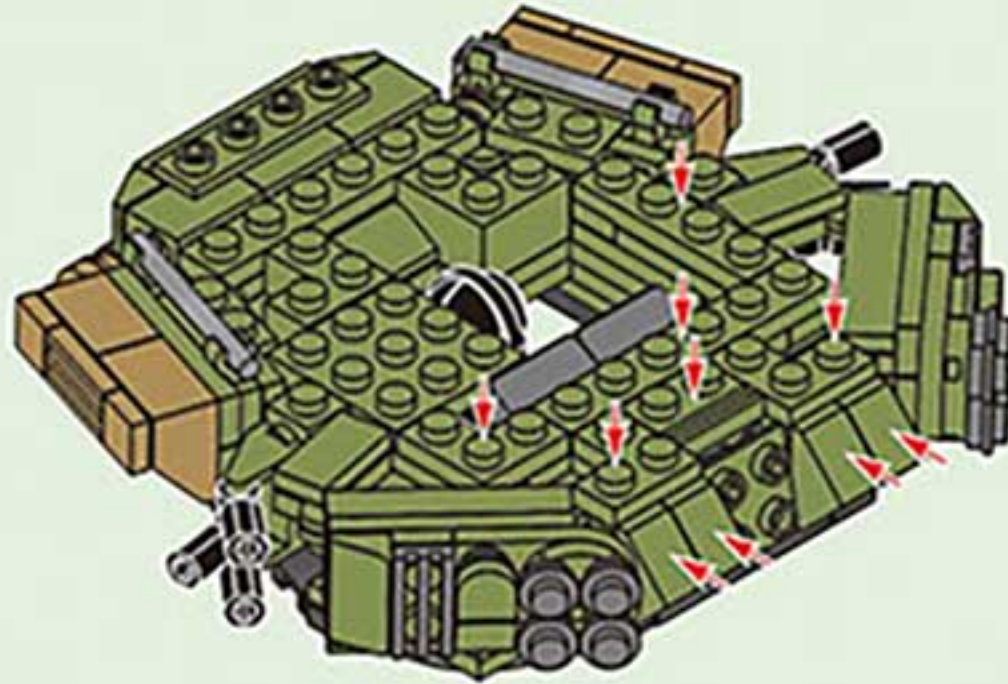

5-2

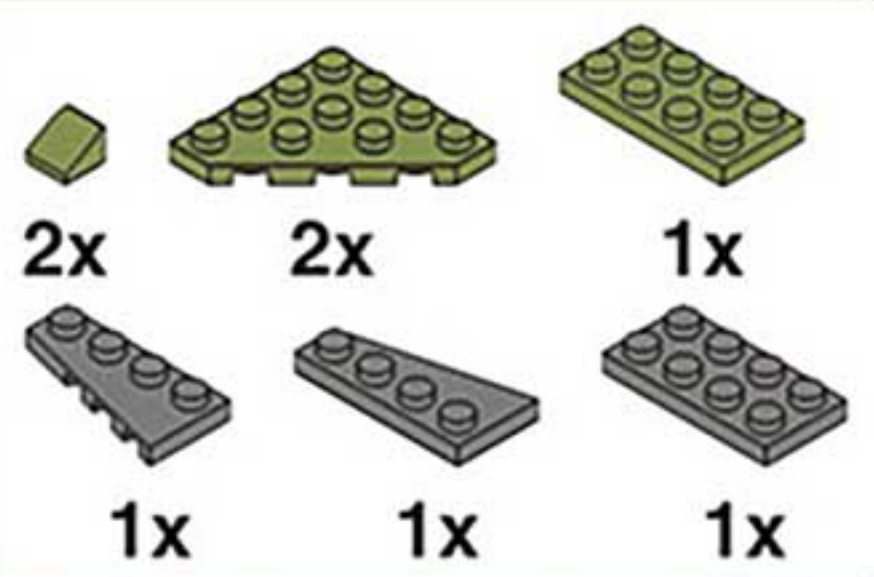
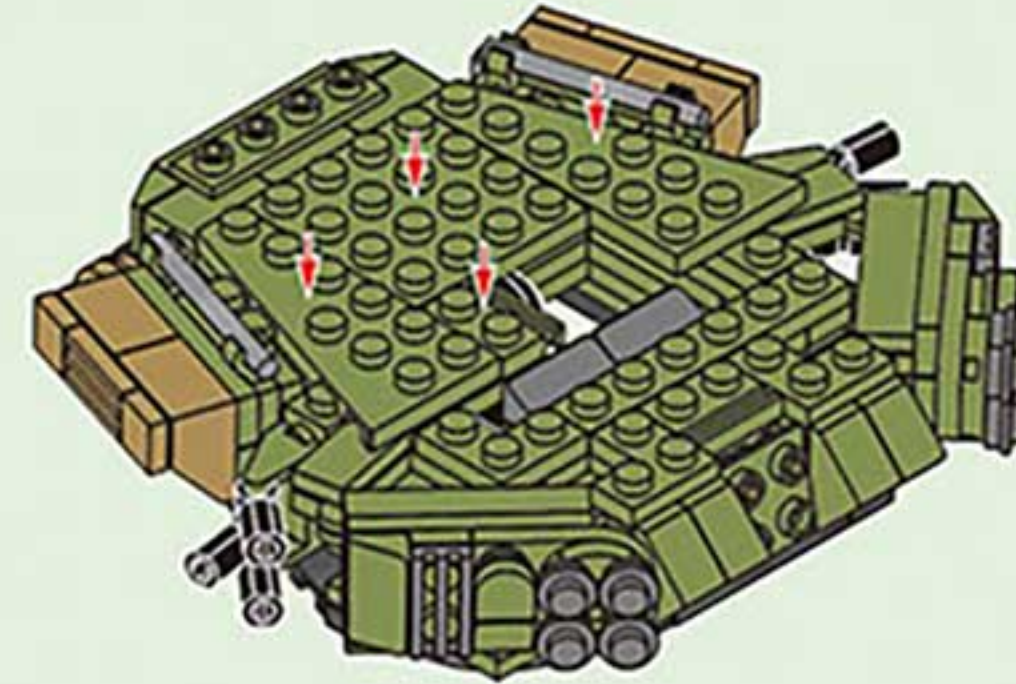

5-3

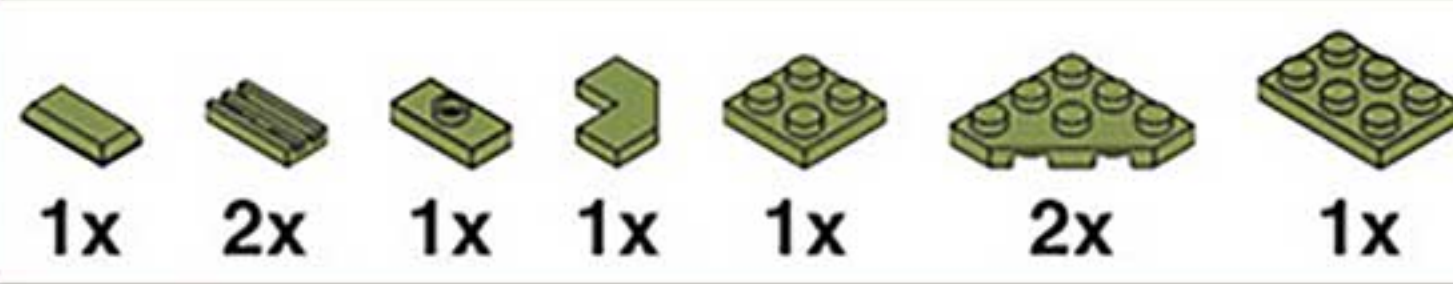
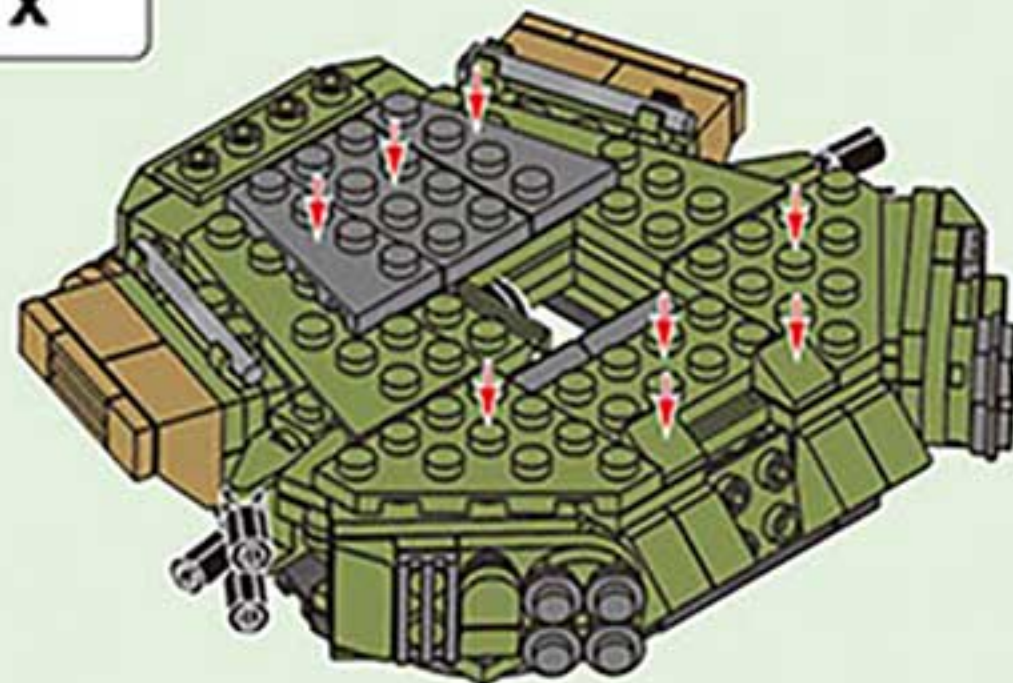

5-4

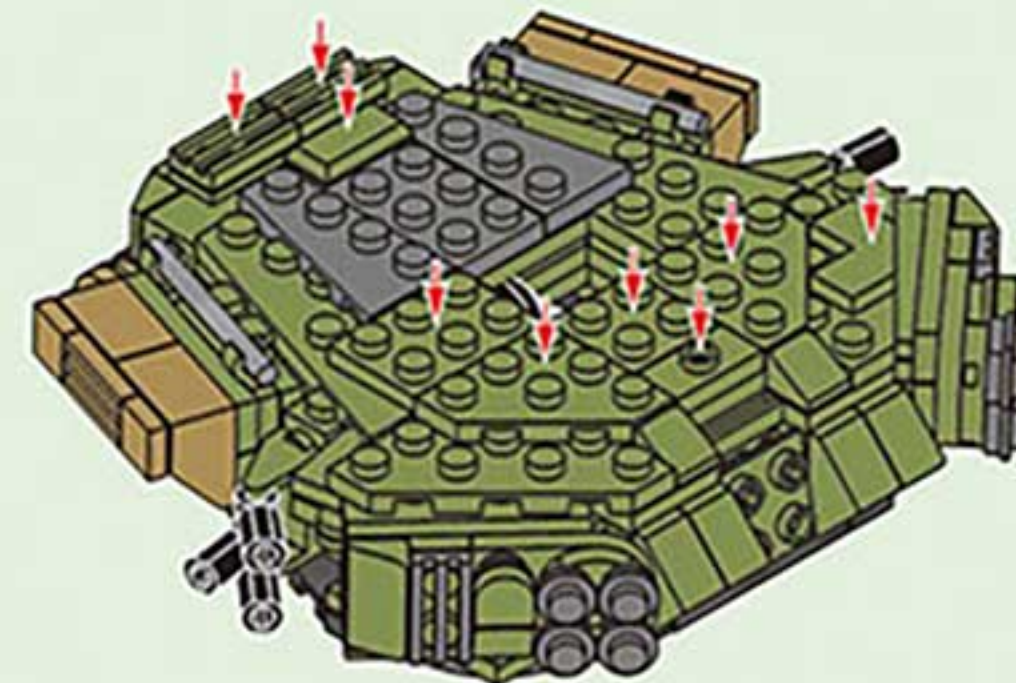



5-5

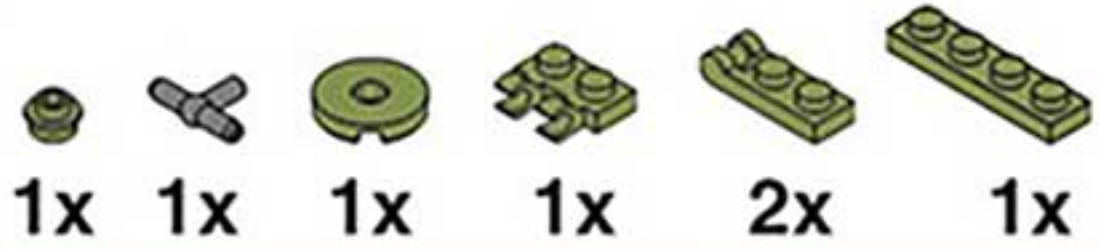
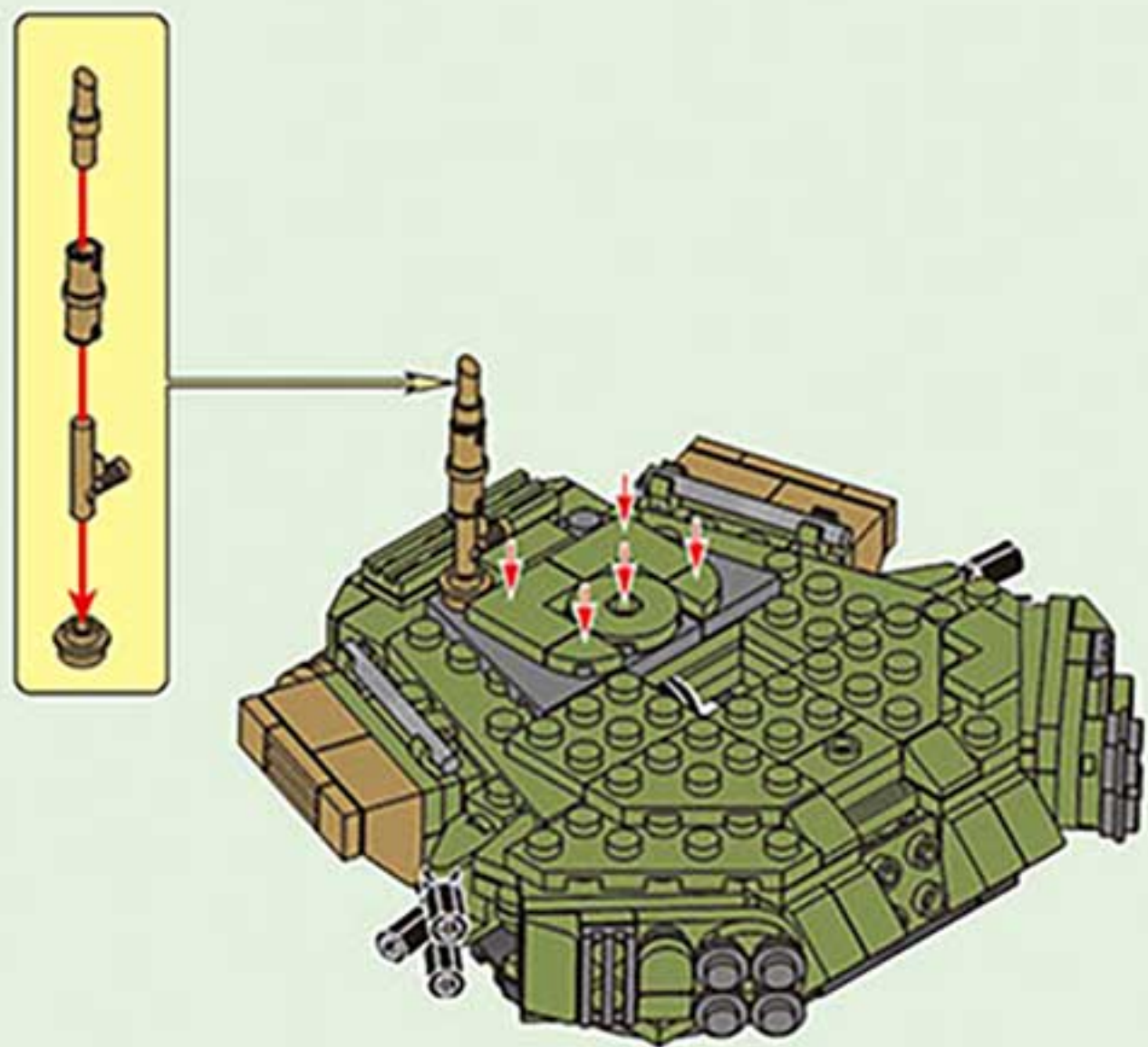

5-6

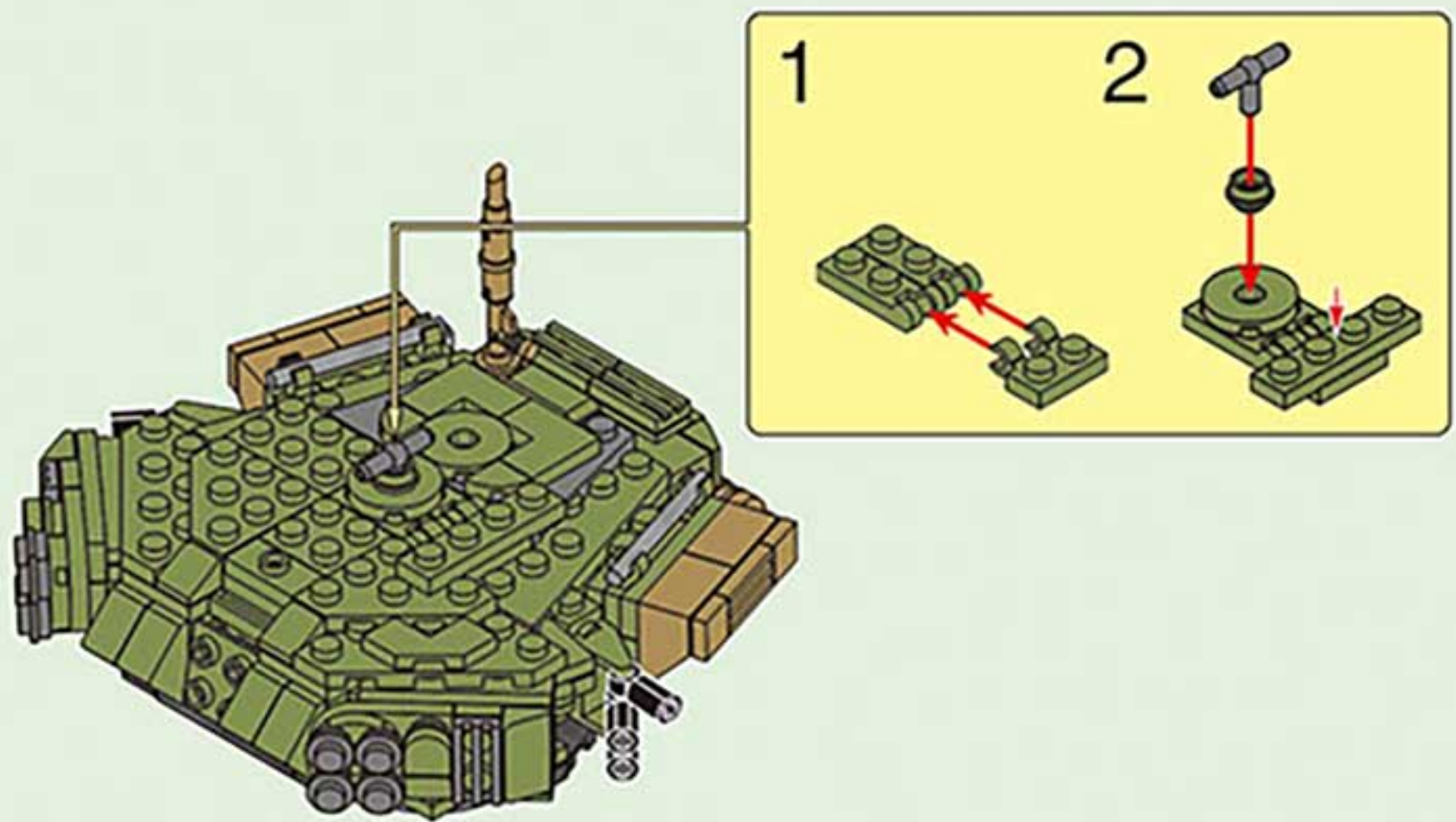



5-7

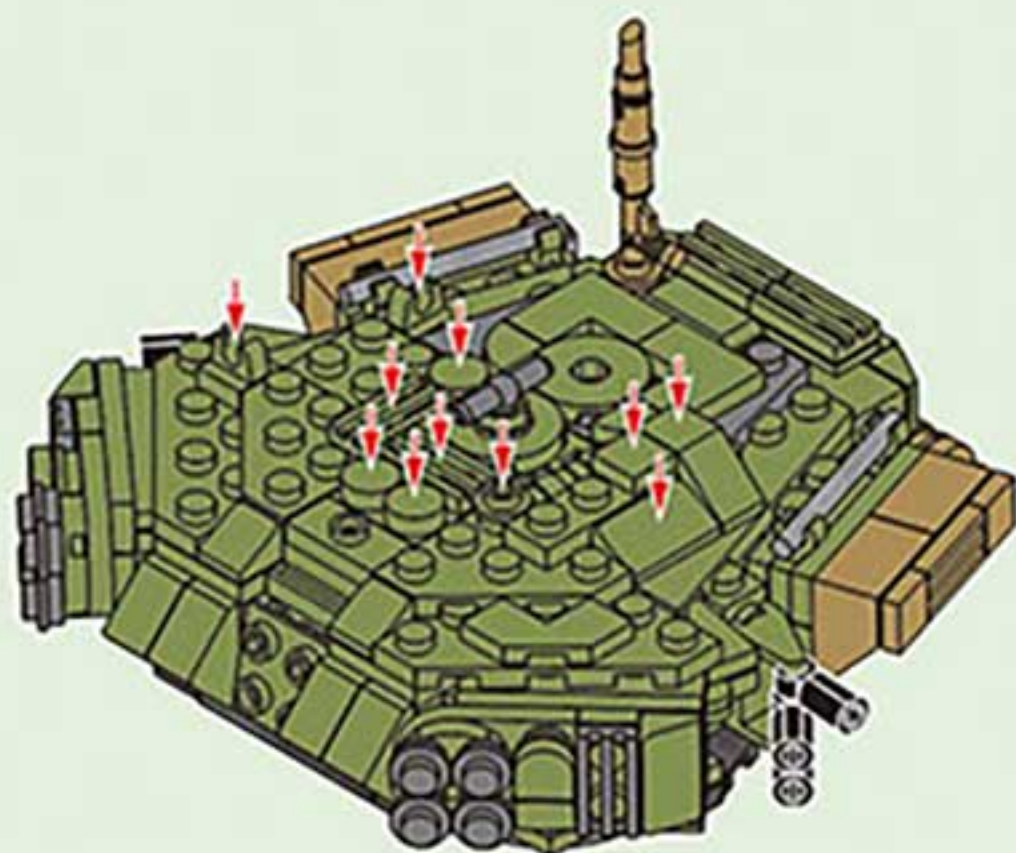

5-8

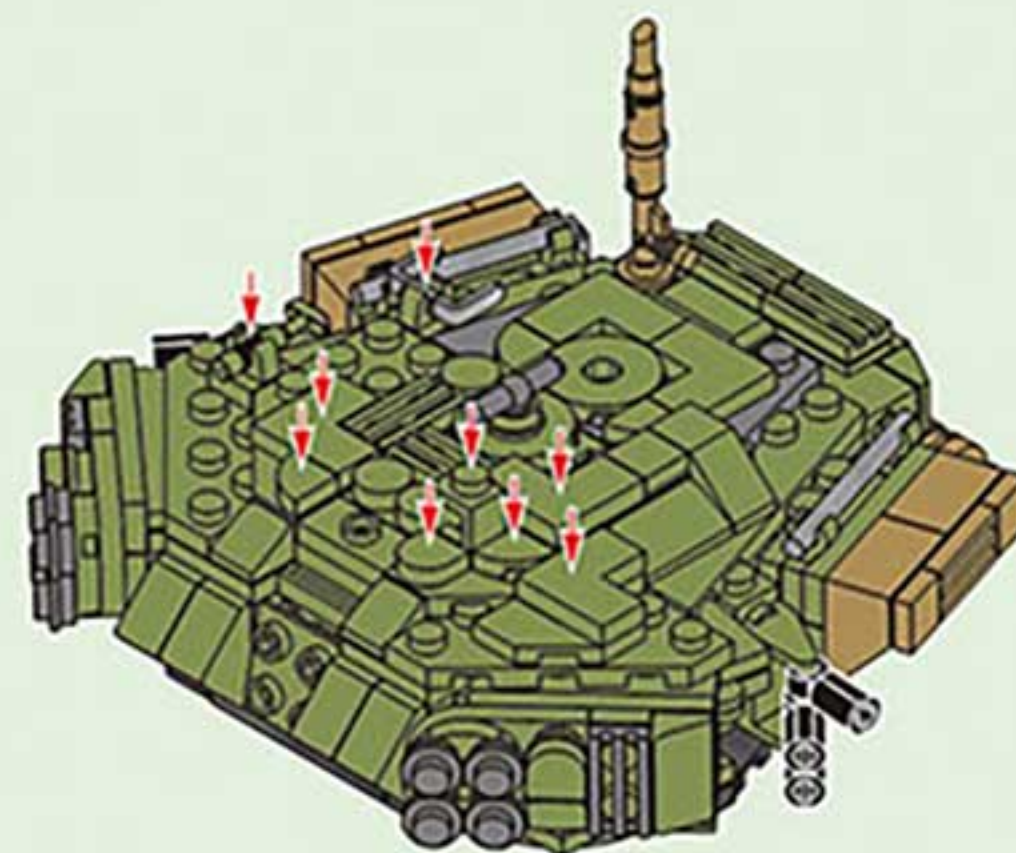

5-9

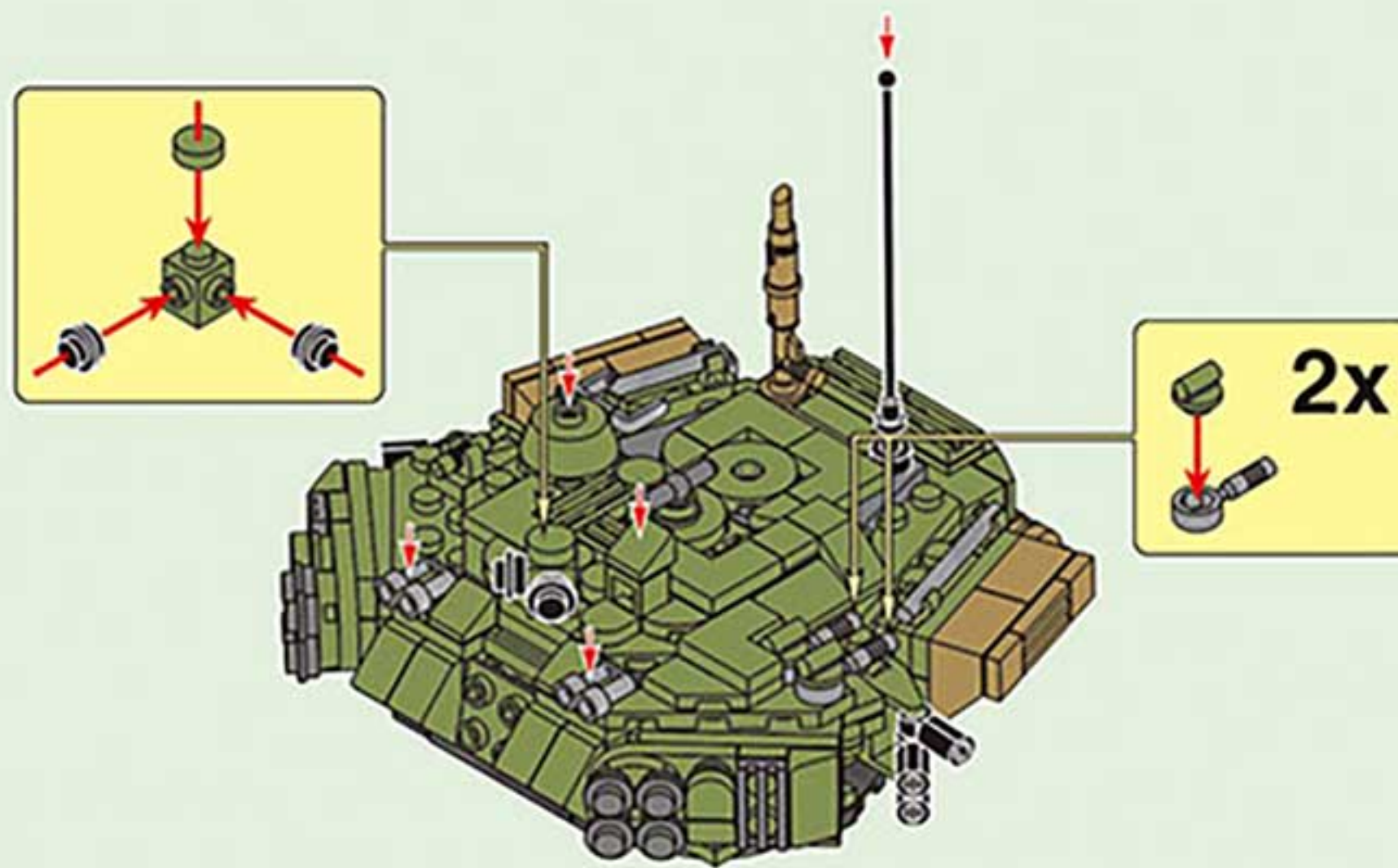

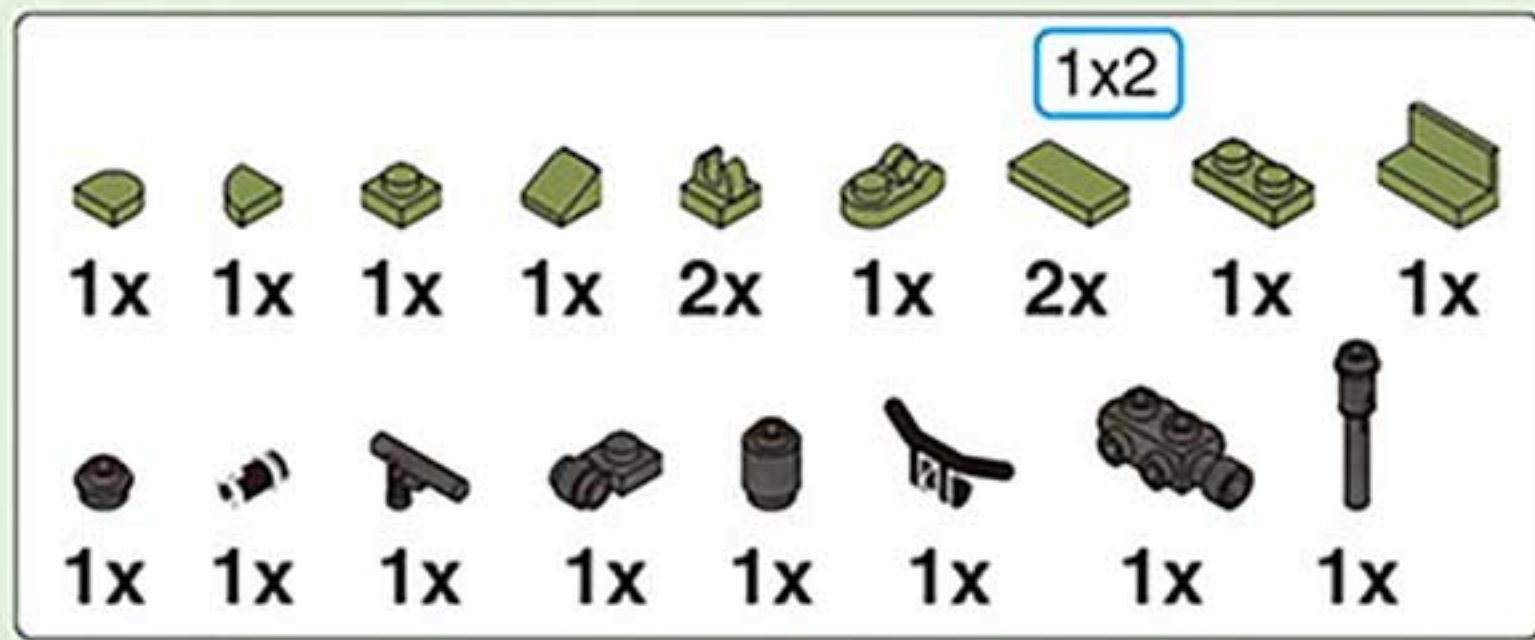

5-10

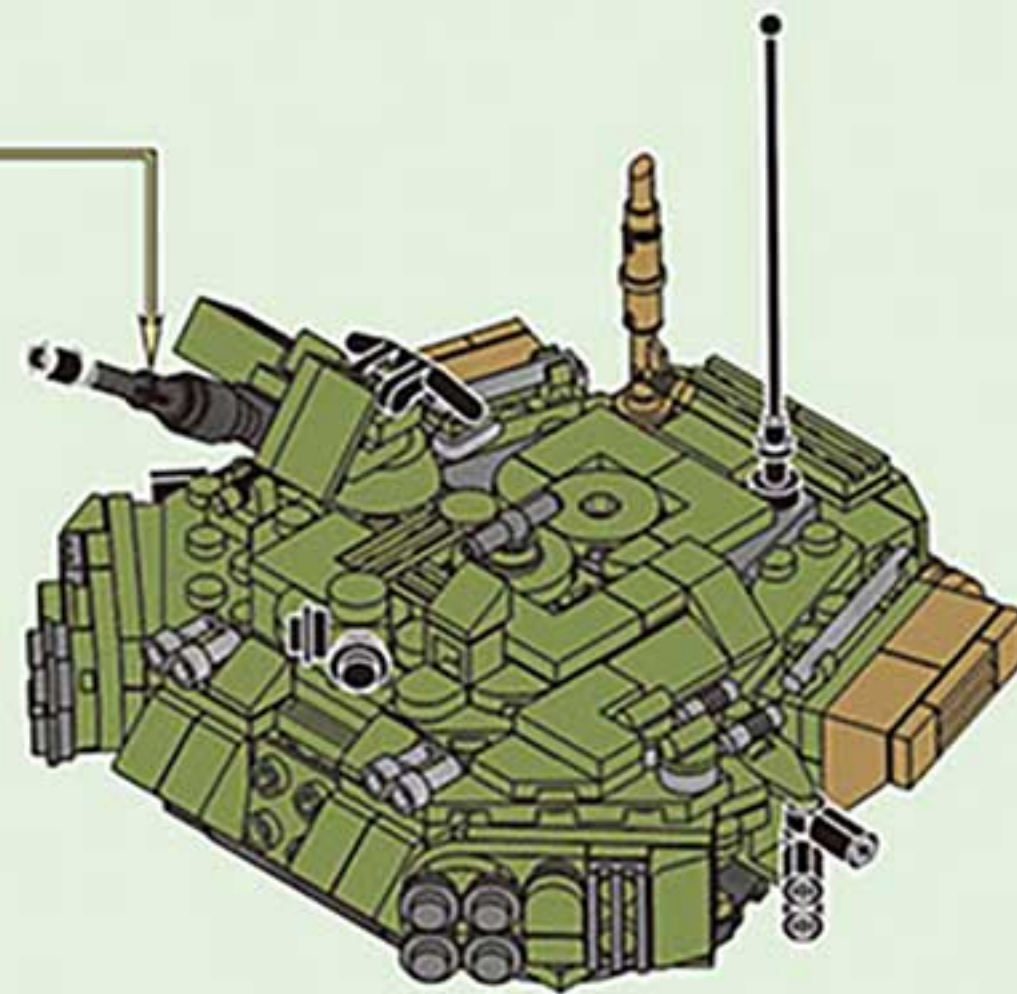
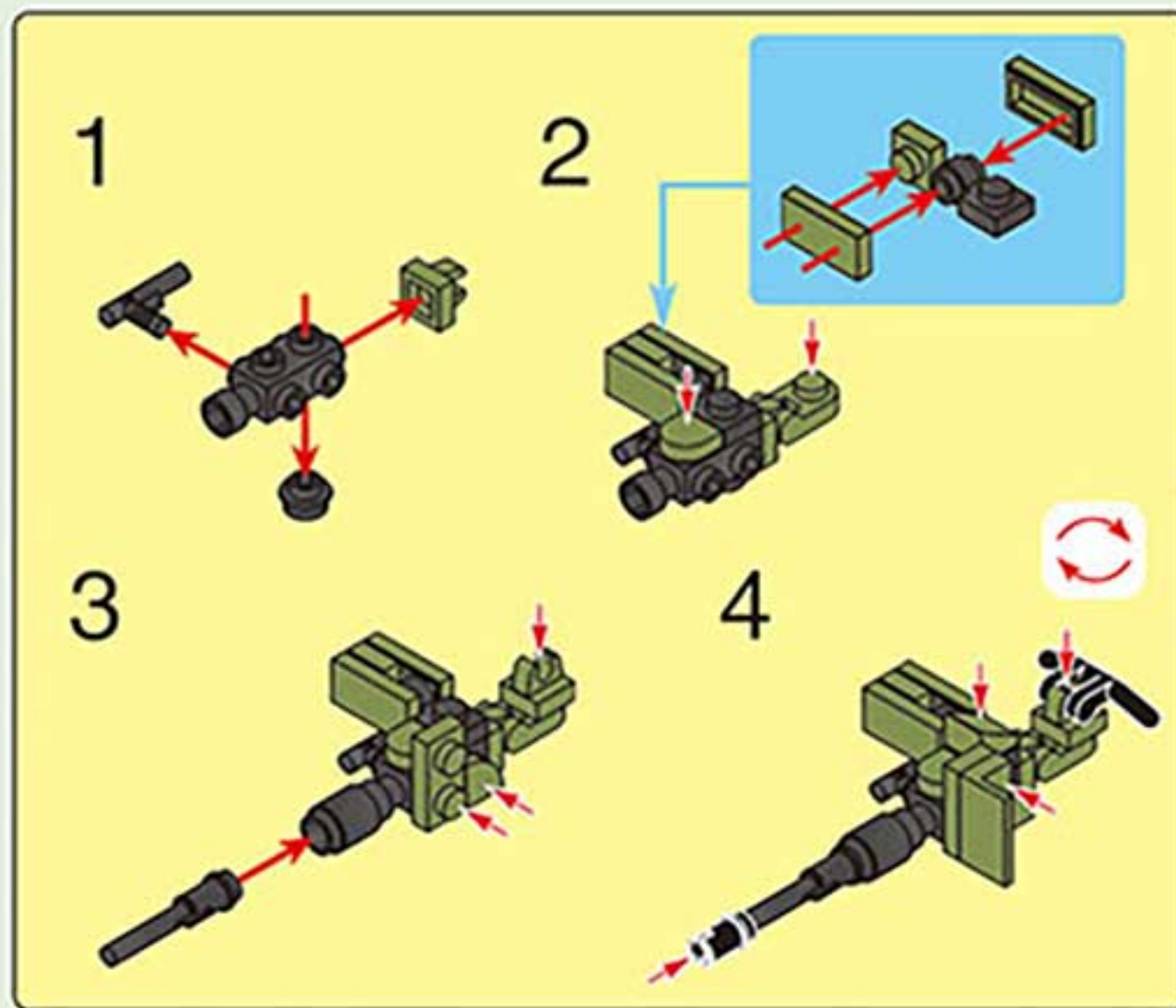

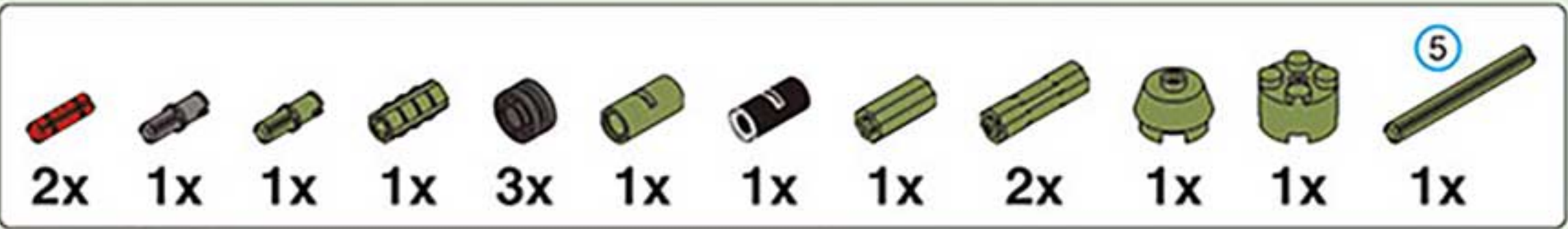

5-11



1

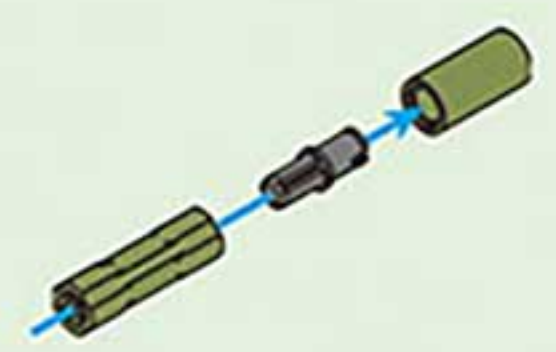

3

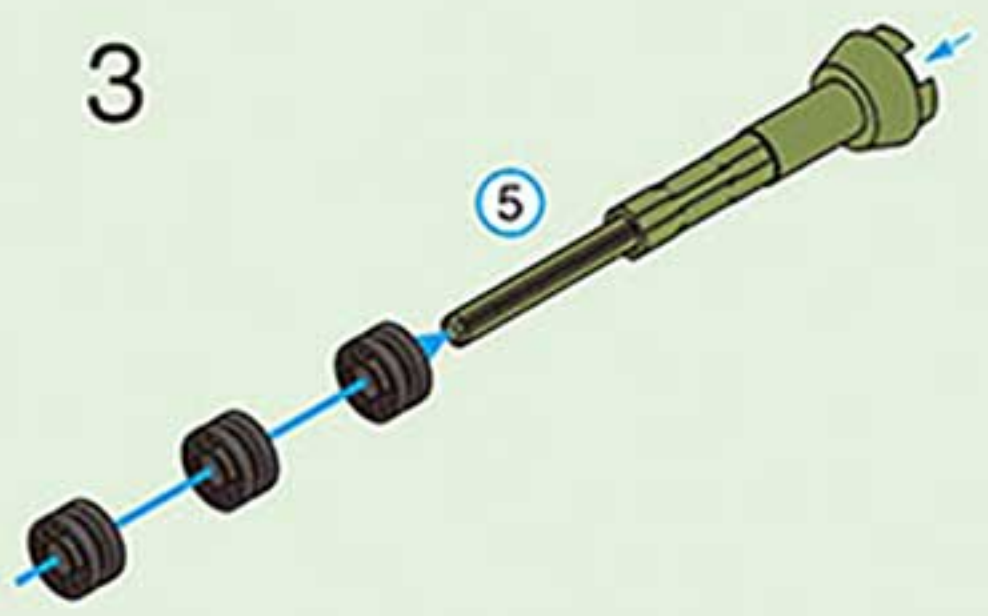

4

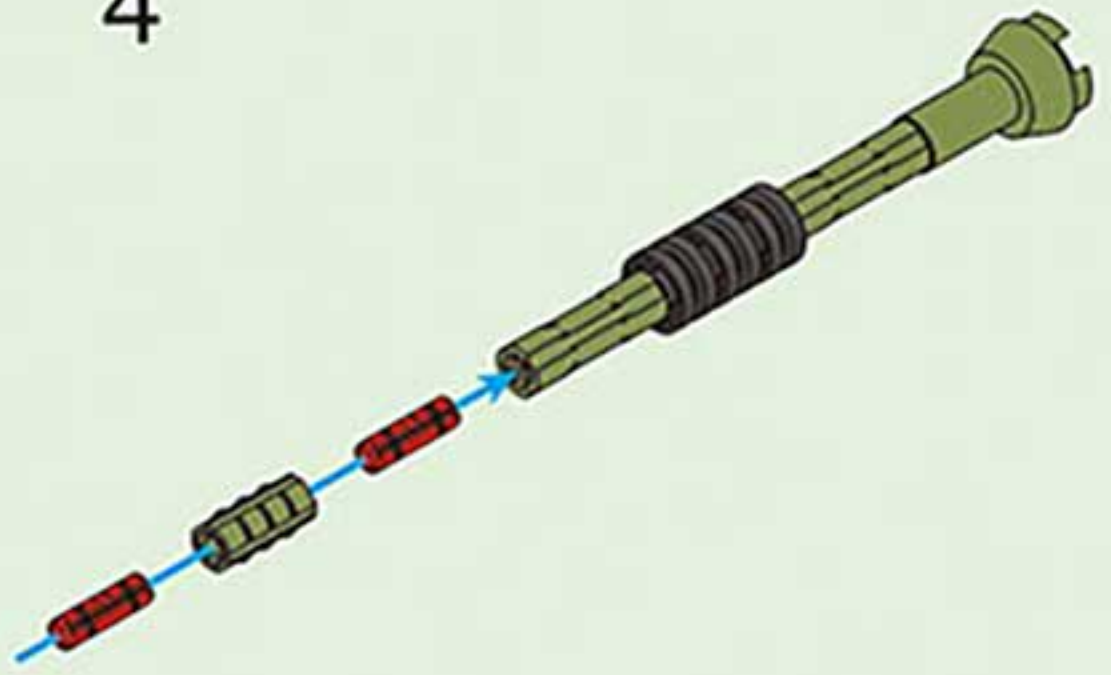

5

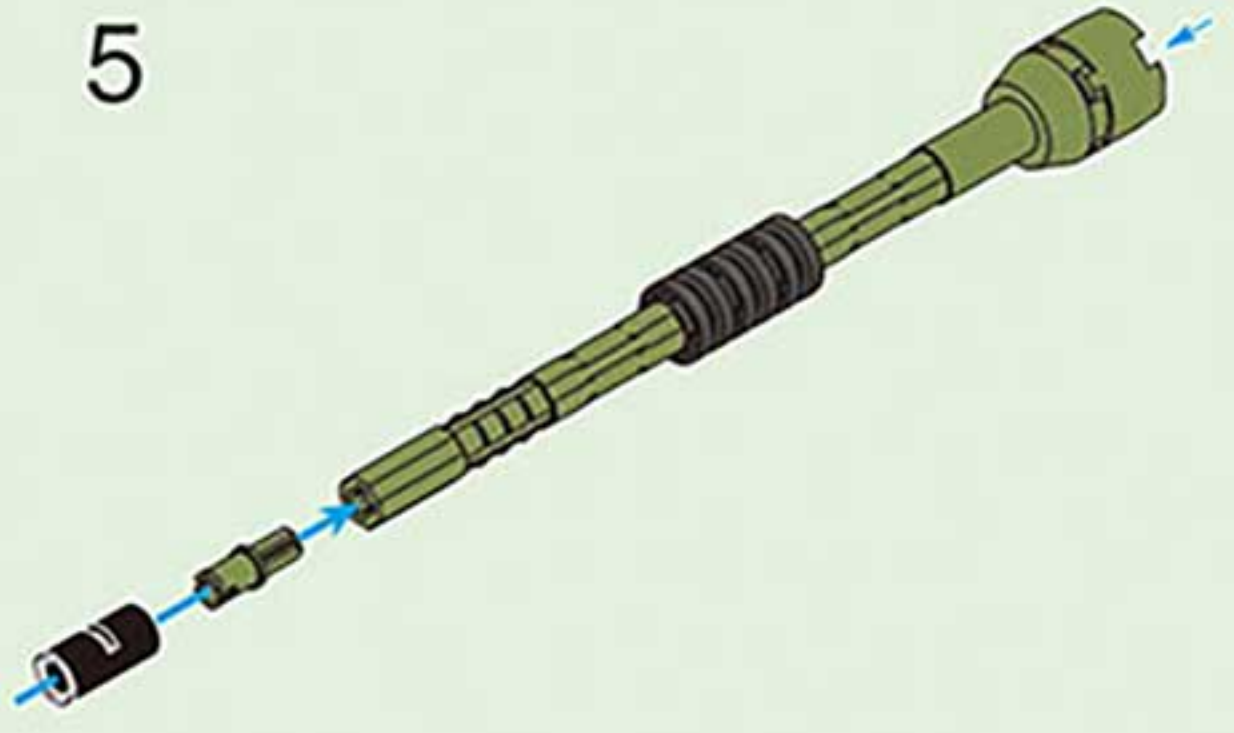

5-12

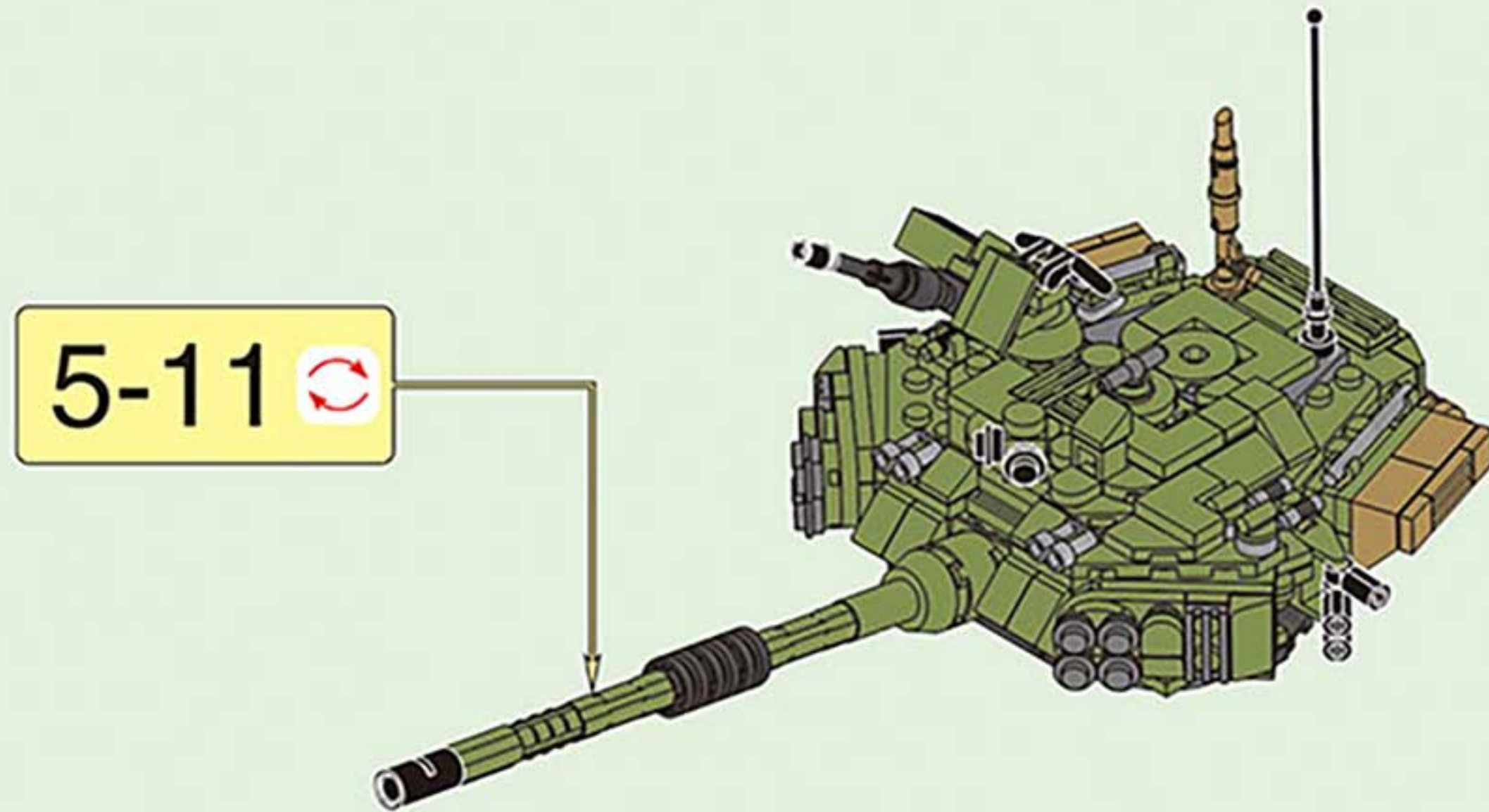

5-13

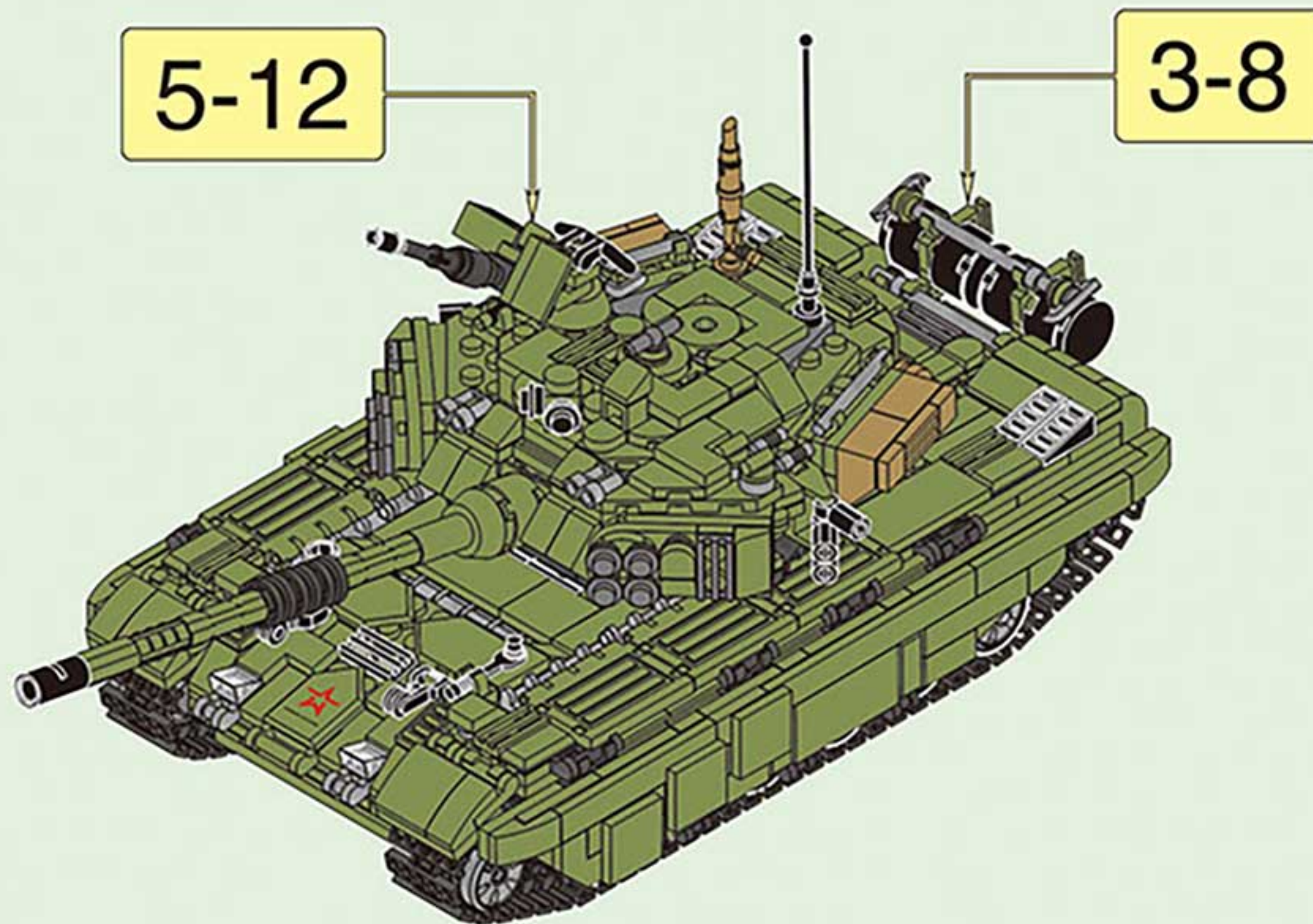

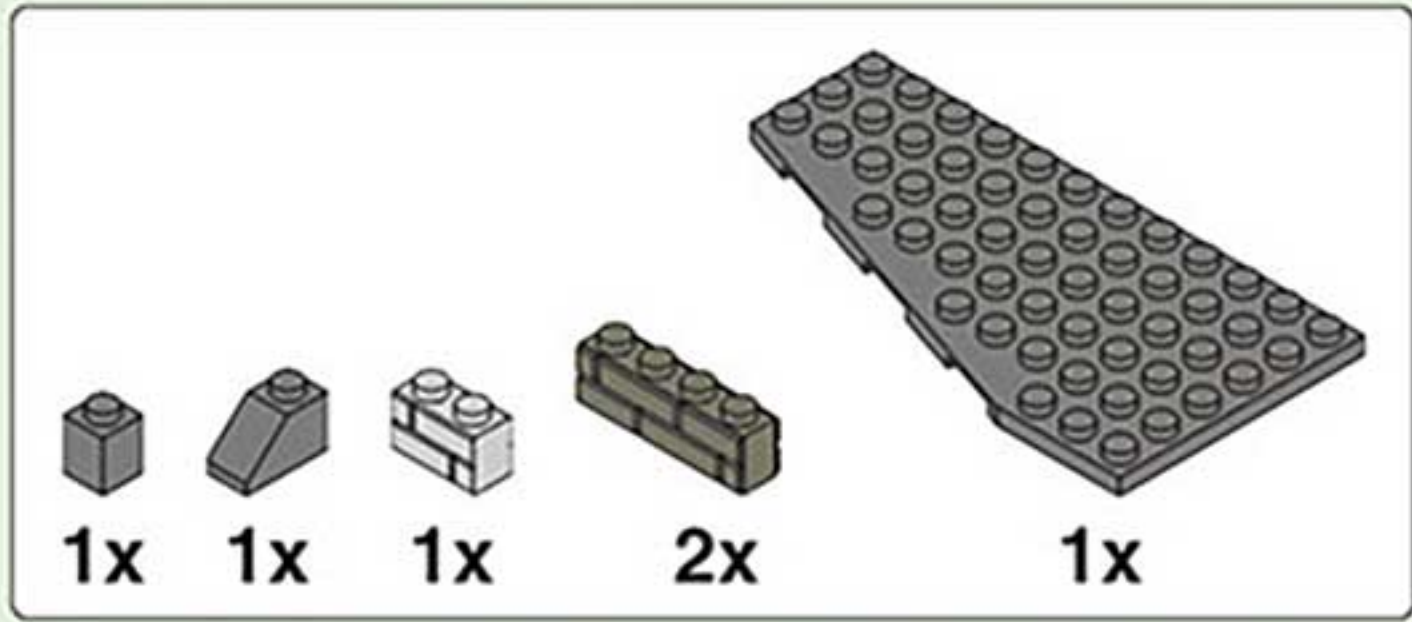

5-14

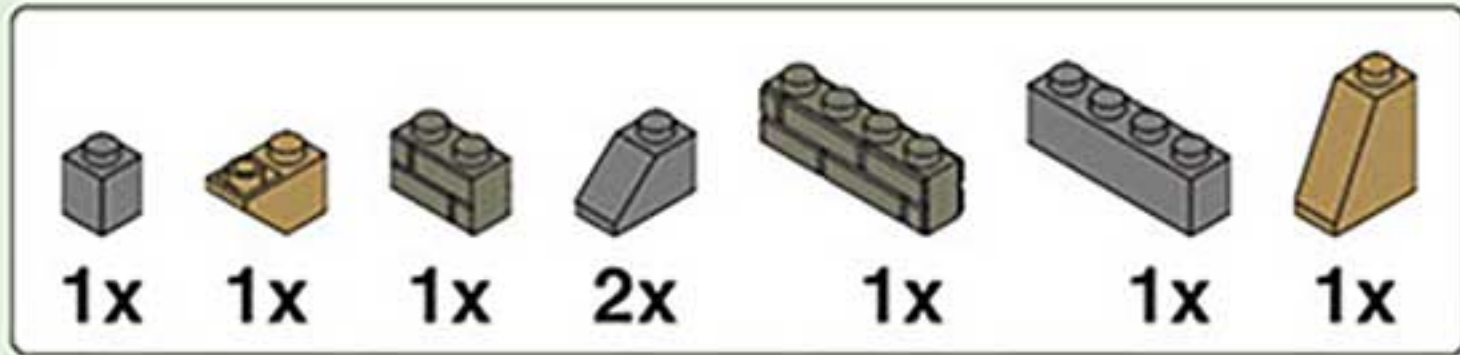
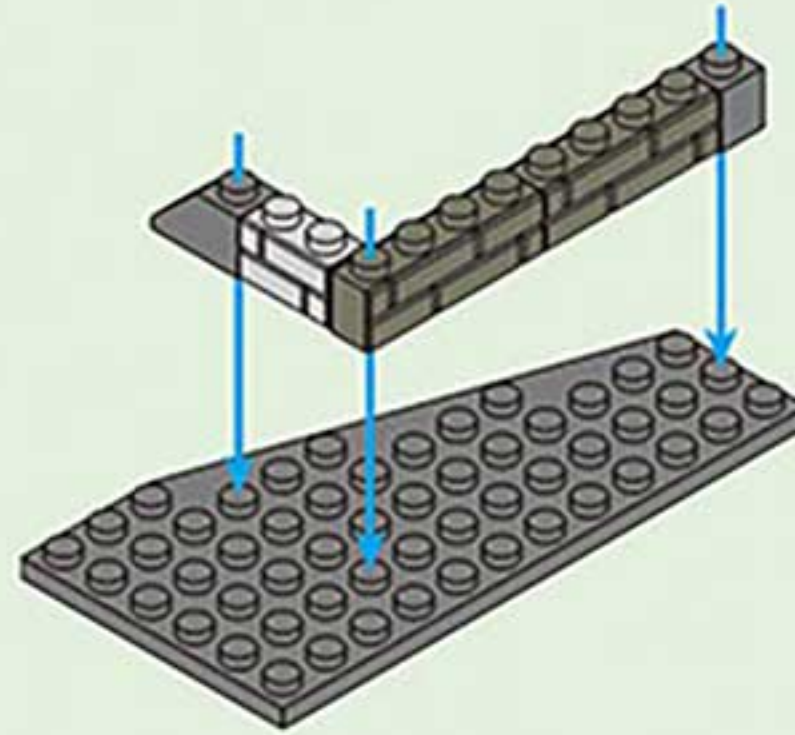

5-15

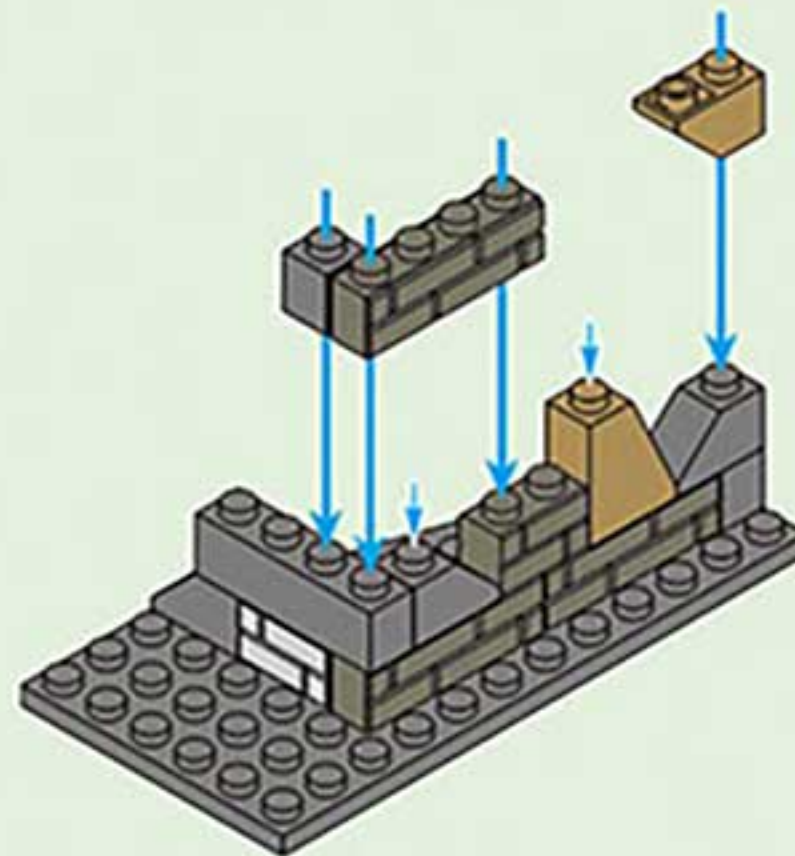

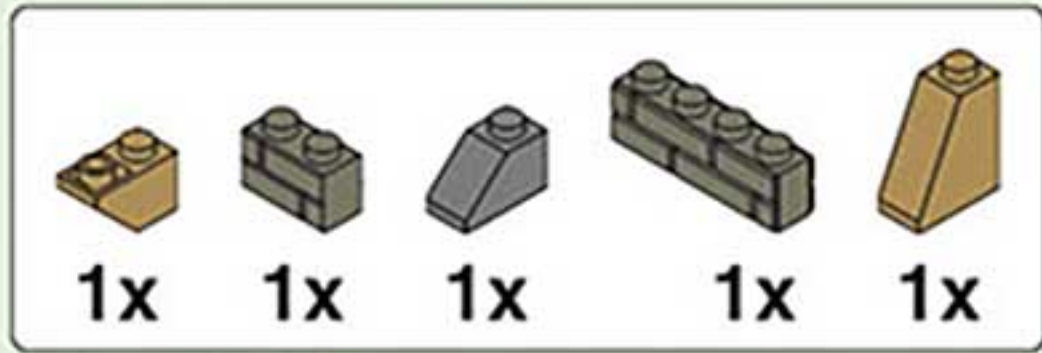

5-16

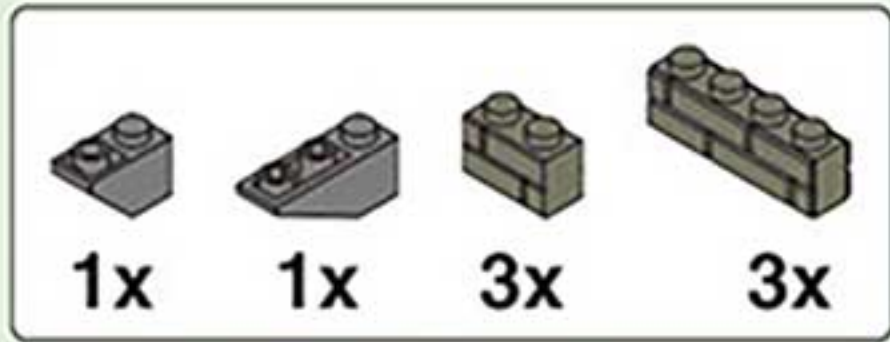
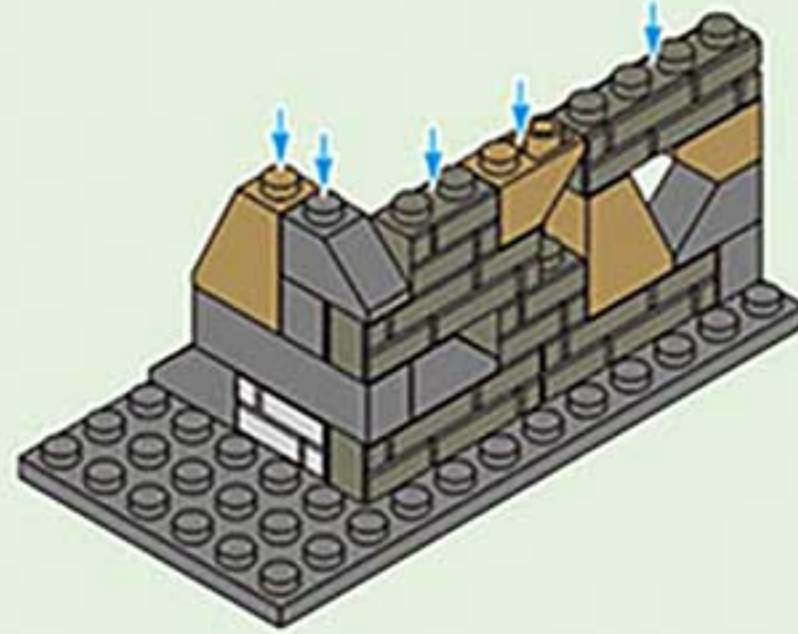

5-17

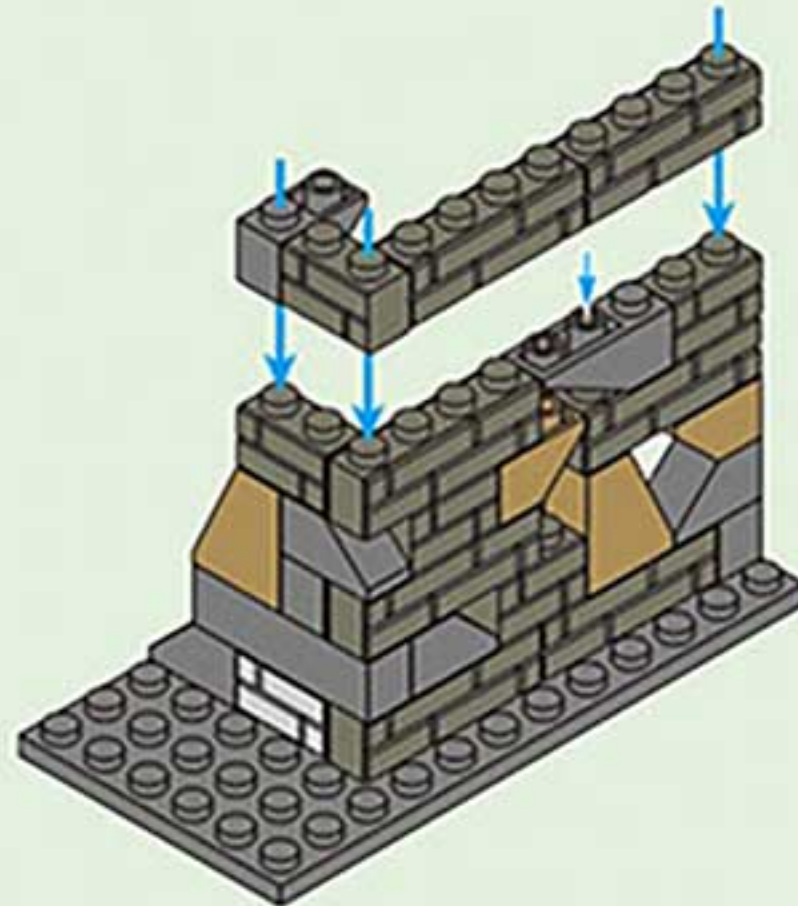

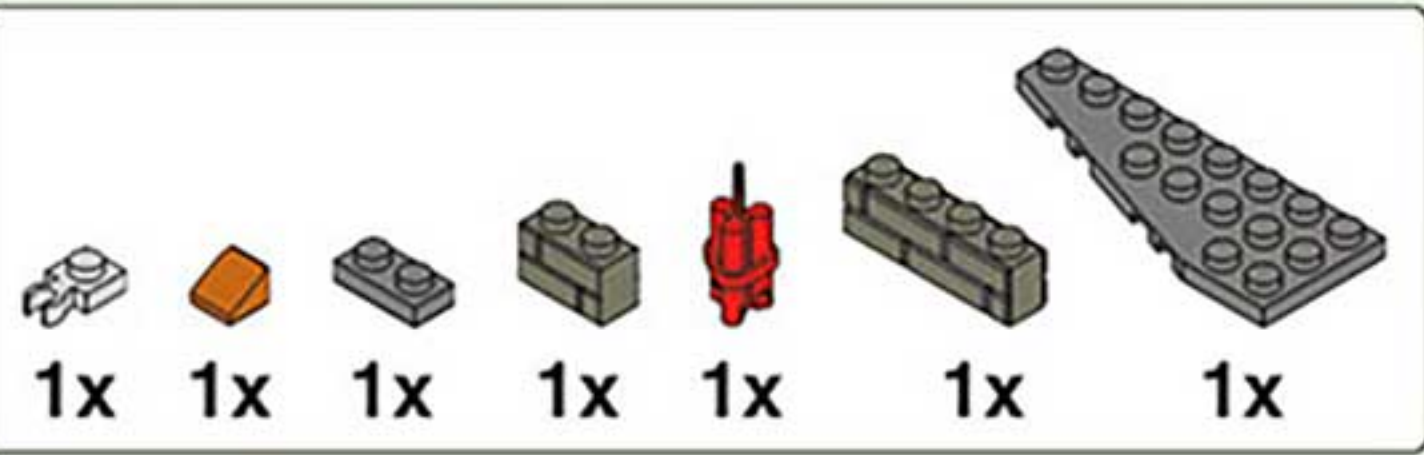

5-18

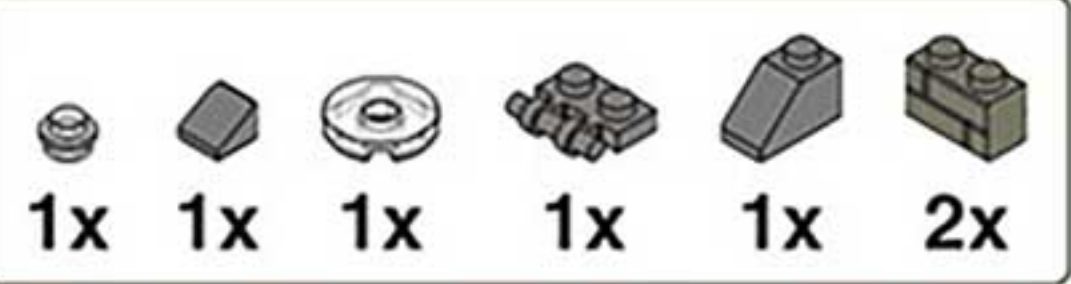
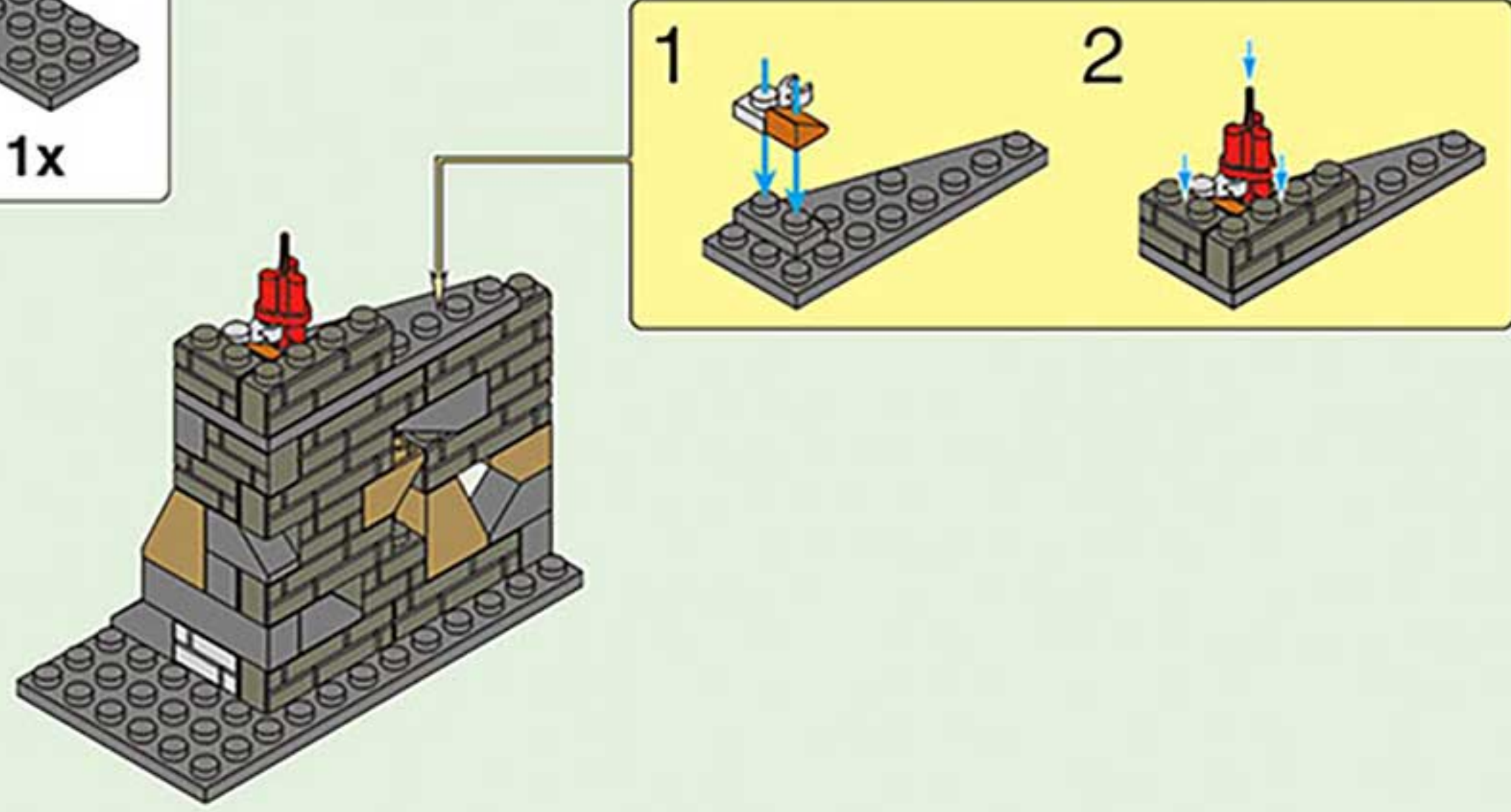

5-19

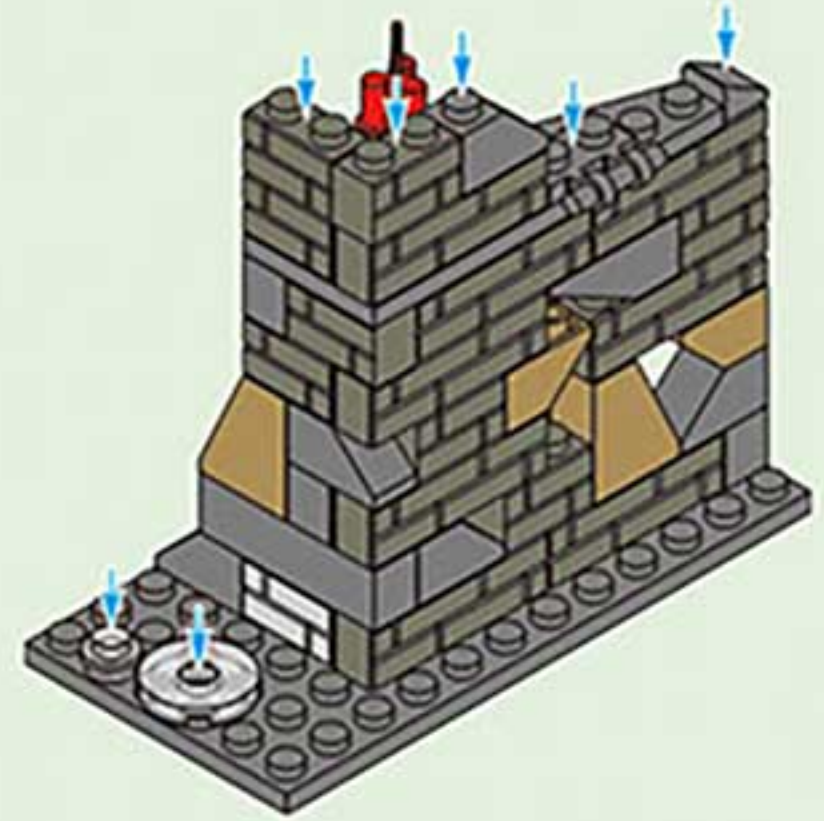



5-20

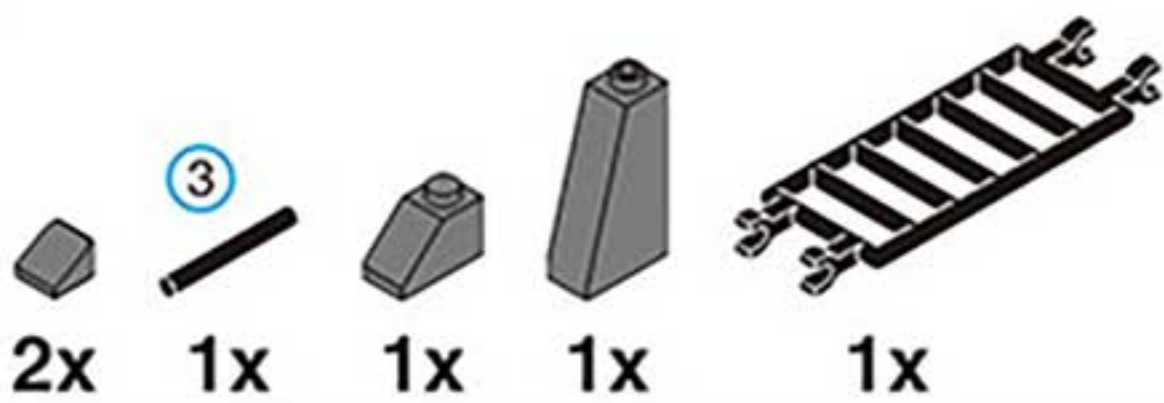
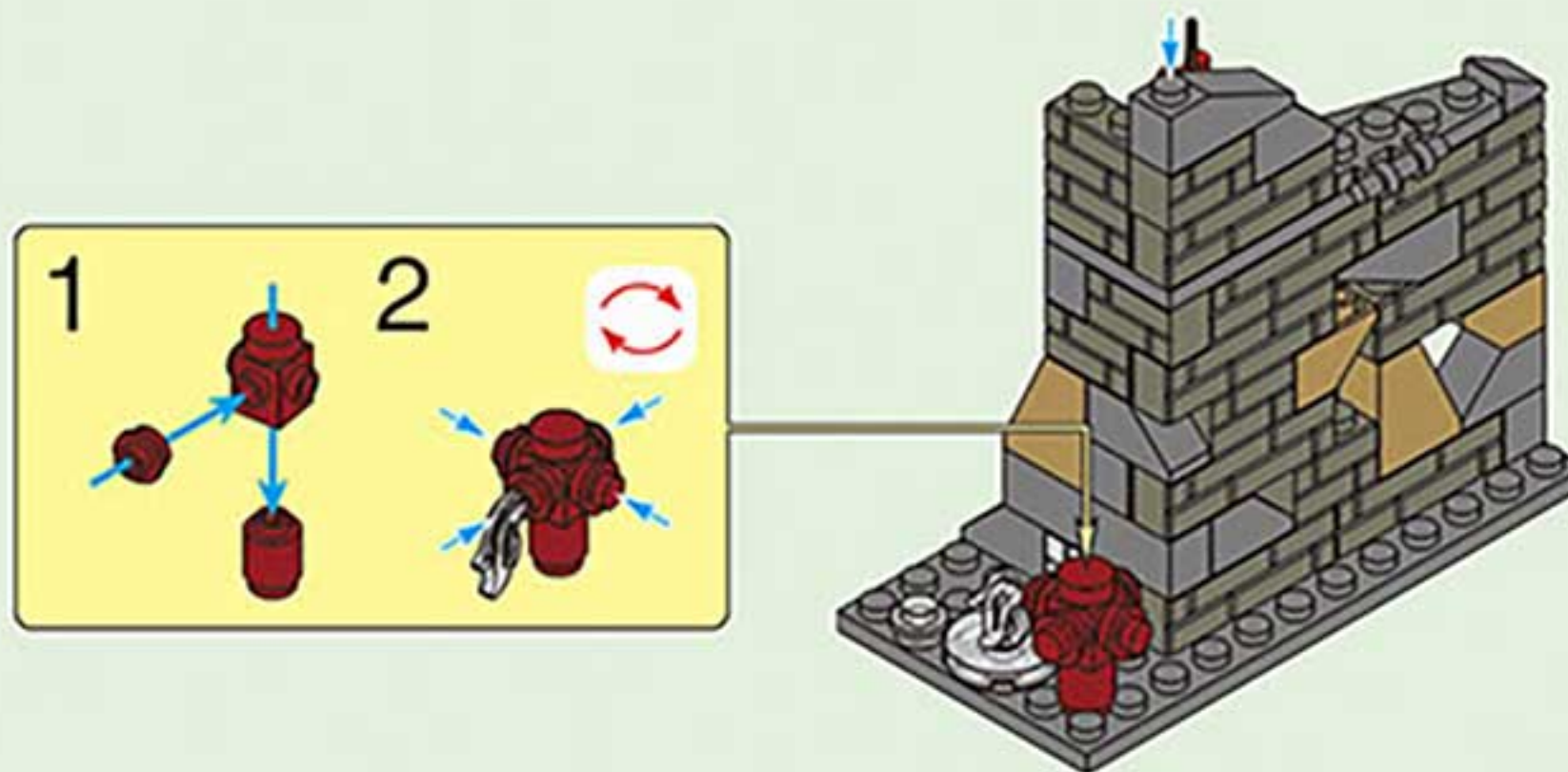

5-21

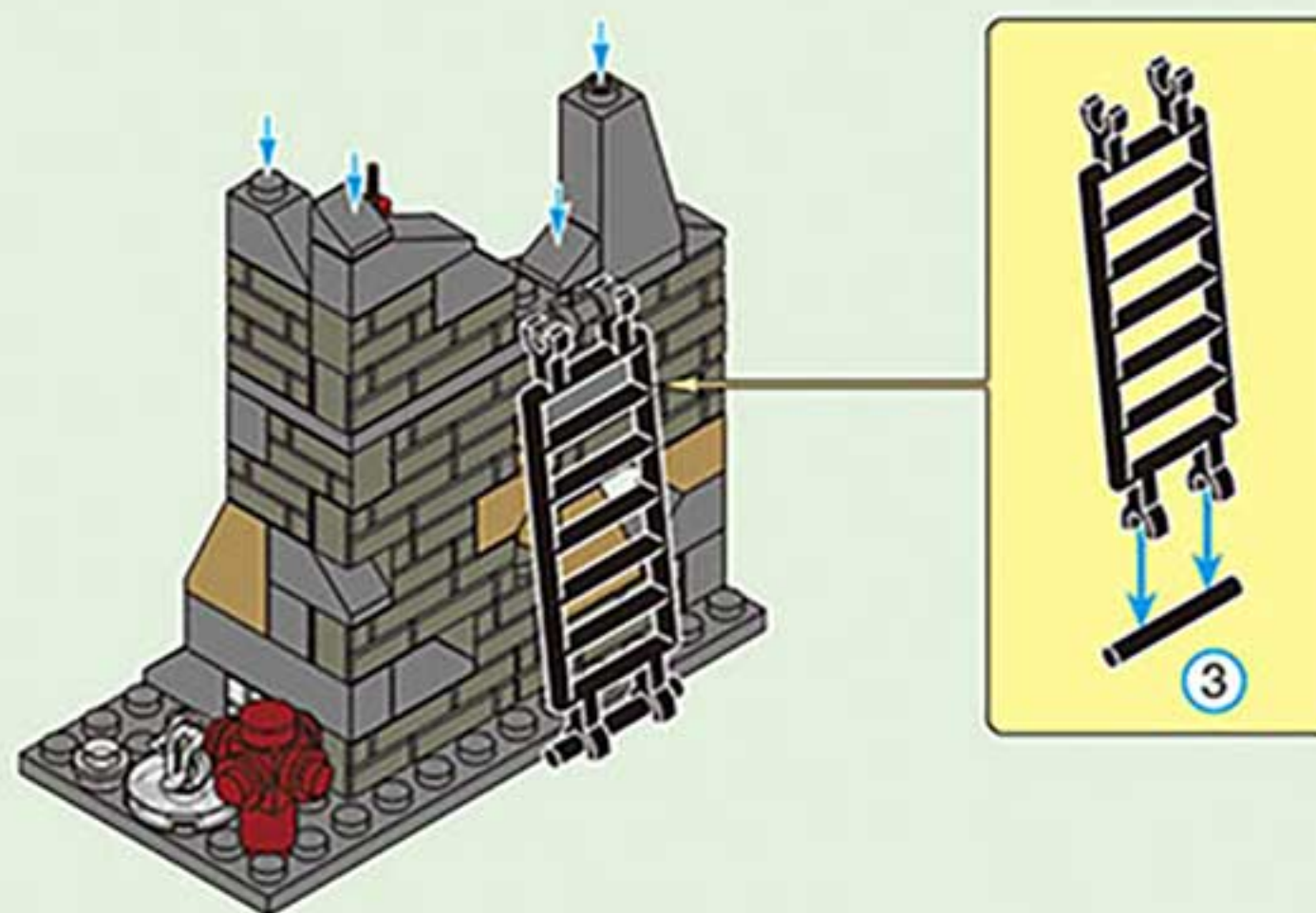

5-22

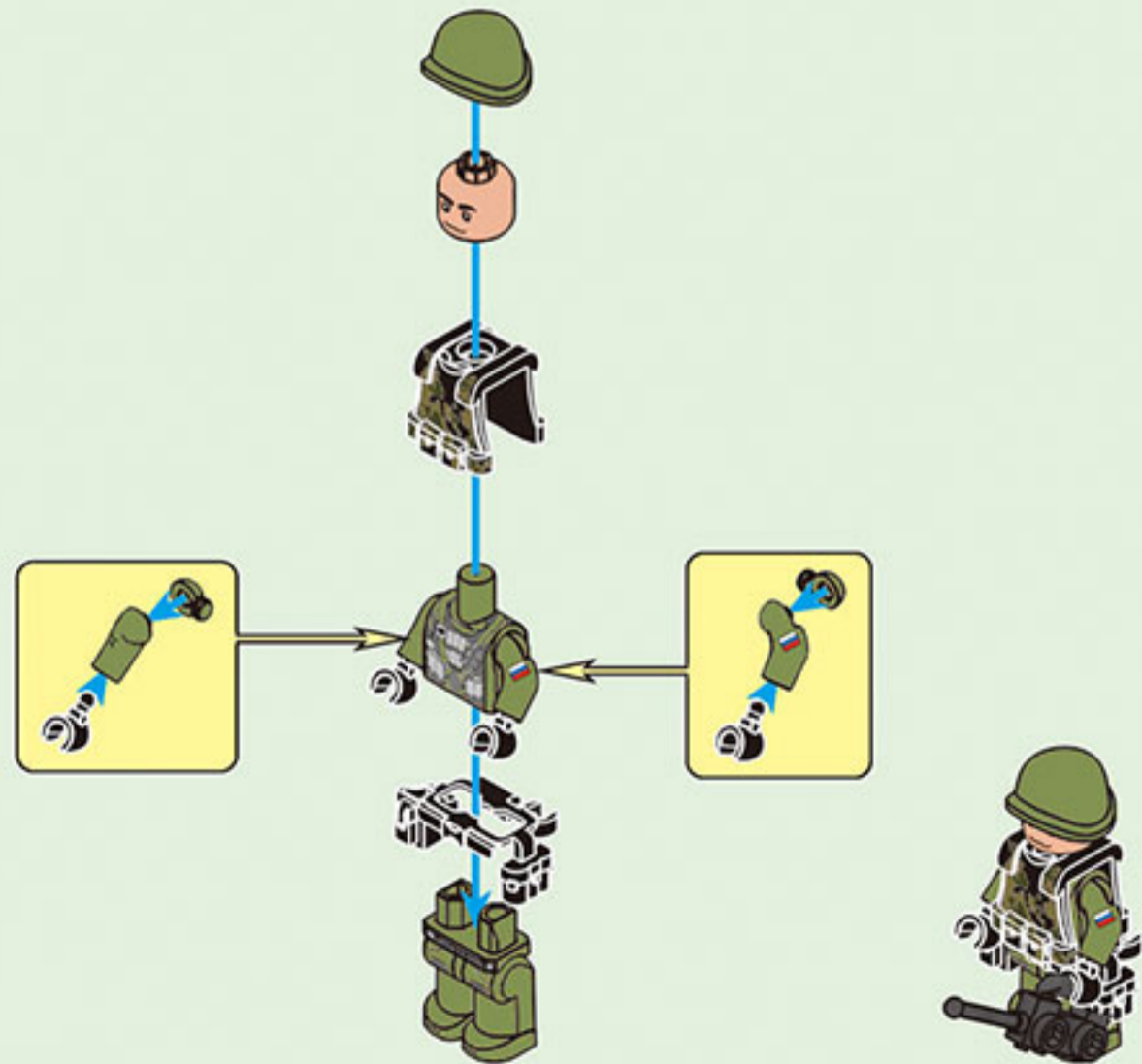

5-23

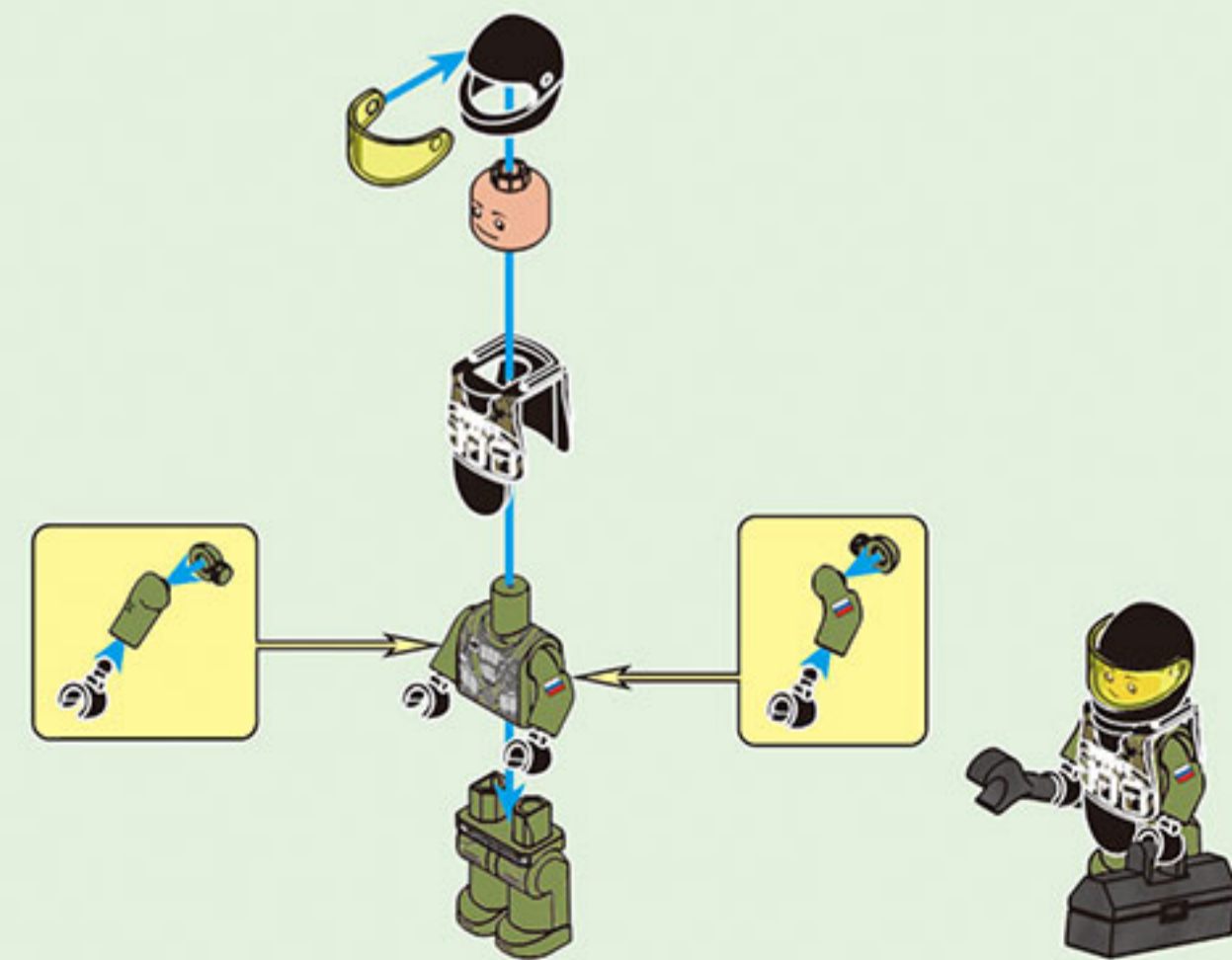

5-24

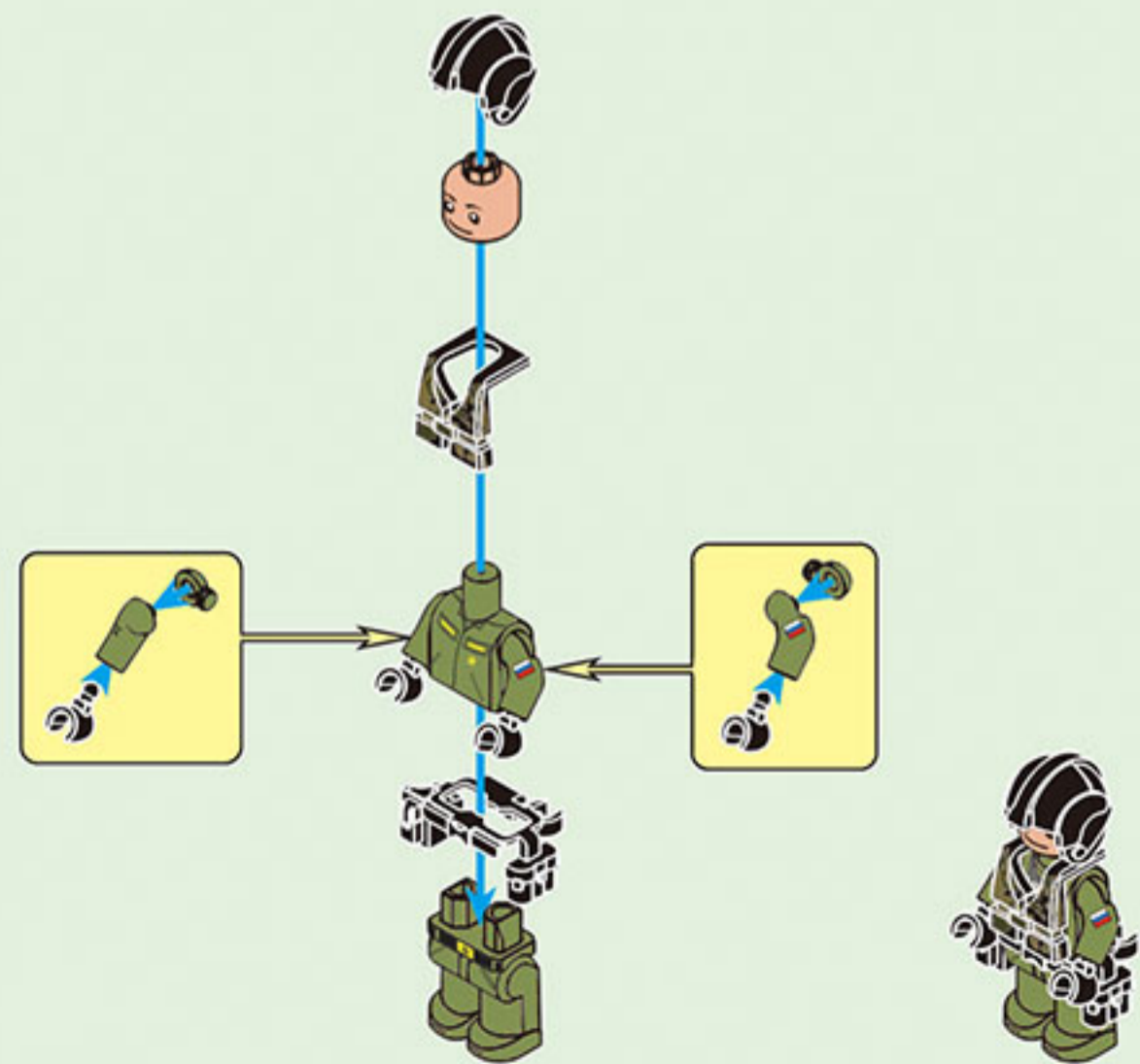

5-25

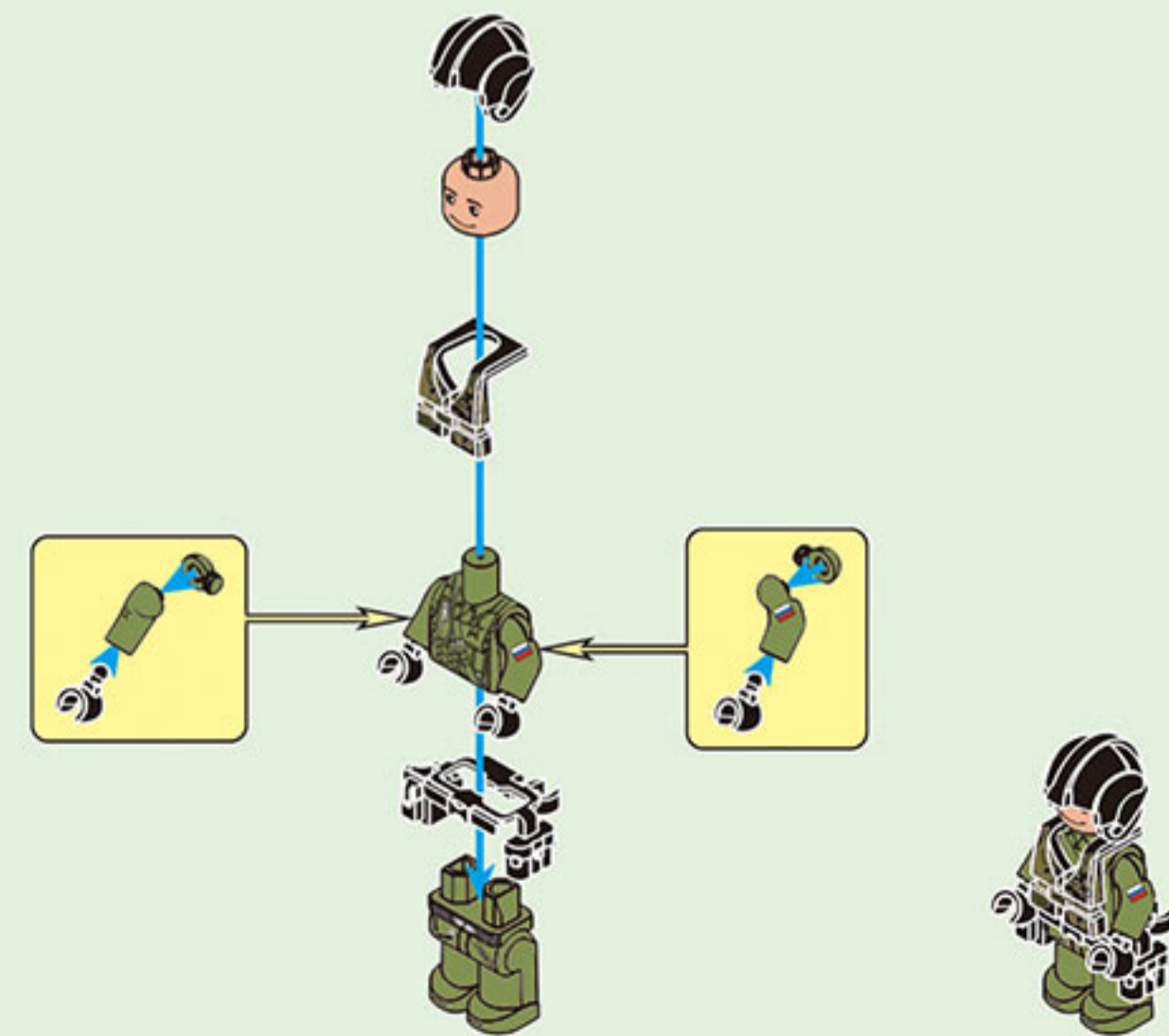

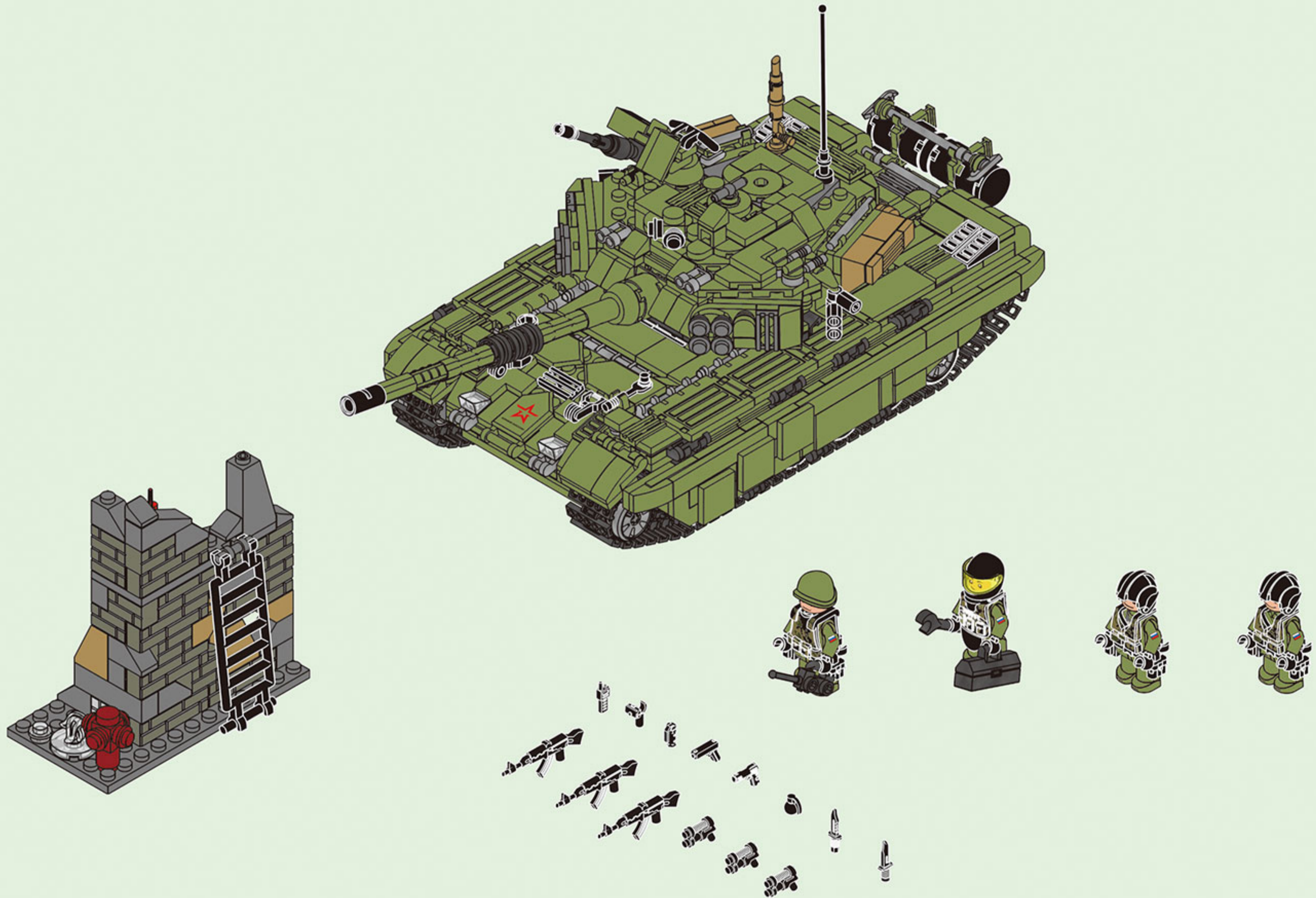



АРМИЯ РОССИИ®

# ООО "РЕГИОН-СЕРВИС"

Пластиковые конструкторы "АРМИЯ РОССИИ".



Конструктор  
"Военный внедорожник"  
AP-01005.



Конструктор  
"Боевой вертолет"  
AP-01007.



Конструктор "Зенитно-ракетный комплекс"  
AP-01001.



Конструктор  
"Военный квадроцикл"  
AP-01003.



Конструктор  
"Танк Т-14 "АРМАТА"  
AP-01009.



Конструктор  
"Авианесущий Крейсер"  
AP-01012.

